

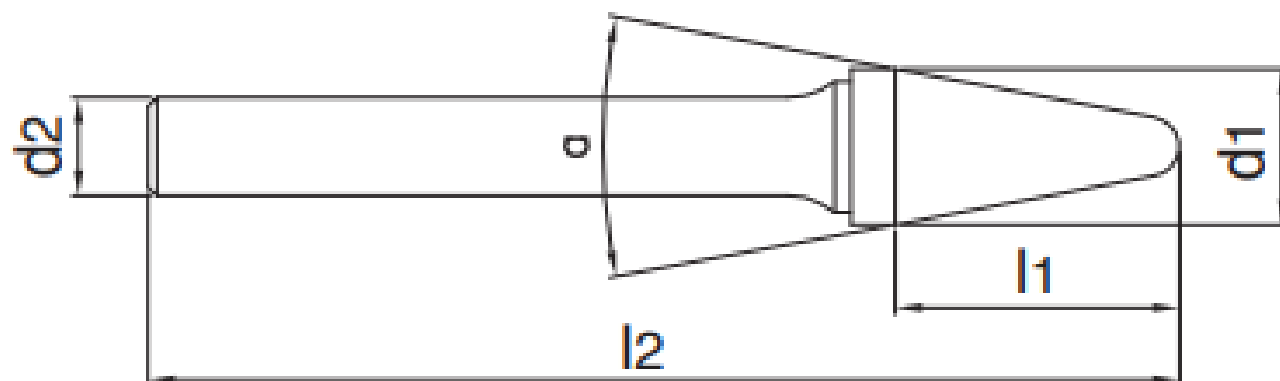









# LIMAS ROTATIVAS MOLDES E MATRIZES



## LIMAS

	CÓDIGO	d1	d2	l1	l2	a
	SA - 51M	6,3	3	12,7	50	-
	SB - 51M	6,3	3	4,7	43	-
	SC - 51M	6,3	3	12,7	50	-
	SD - 51M	6,3	3	5	44	-
	SE - 51M	6,3	3	9,5	47	-
	SF - 51M	6,3	3	12,7	50	-
	SG - 51M	6,3	3	12,7	50	-
	SM - 51M	6,3	3	12,7	54	22°
	SN - 51M	6,3	3	6	44	10°