



CATÁLOGO
SUPORTES
INTERCAMBIÁVEIS
EXTERNOS

GRUPO



WWW.FERMEC.COM.BR



SUORTES INTERCAMBIÁVEIS EXTERNOS

• *FIXAÇÃO POR ALAVANCA*

PCBNR.....	13
PCKNR.....	14
PCLCR.....	15
PCLNR.....	16
PDACR.....	17
PDJNR.....	18
PDNNN.....	19
PRGCR.....	20
PRGNR.....	21
N176.39.....	22
PSBNR.....	23
PSDNN.....	24
PSKNR.....	25
PSSNR.....	26
PTFNR.....	27
PTGNR.....	28
PTTNR.....	29
PVACR.....	30





• **FIXAÇÃO POR PINO E GRAMPO**

MCBNR	31
MCKNR	32
MCLNR	33
MCDNN	34
MDJNR	35
MDNNN	36
MRDNN	37
MSBNR	38
MSDNN	39
MSKNR	40
MSSNR	41
MTFNR	42
MTGNR	43
MTSNR	44
MVJNR	45
MVVNN	46
MWLNR-M2	47

• **FIXAÇÃO POR CUNHA-GRAMPO**

MTENN	48
--------------------	-----------



MTJNR 49

MWLNR 50

• *FIXAÇÃO POR PARAFUSO TORX*

SCACR 51

SCBCR 52

SCKCR 53

SCLCR 54

SCSCR 55

SDACR 56

SDHCR 57

SDJCR 58

SDNCN 59

SRDCN 60

SRDCR 61

SRSCR 62

SSDCN 63

SSSCR 64

STD CR 65

STFCR 66

STGCR 67



STTCR.....	68
SVACR.....	69
SVHBR.....	70
SVHCR-R2.....	71
SVJBR / SVJCR.....	72
SVVBN / SVVCN.....	73
SVPBR.....	74
SVLBR.....	75
SVXCR.....	76
• FIXAÇÃO POR GRAMPO	
CRDCN.....	77
CRDCR.....	78
CSDNN.....	79
CSKNR.....	80
CSSNR.....	81
CTFNR.....	82
• FIXAÇÃO POR GRAMPO-PARAFUSO	
CTJNR.....	83
CSBPR.....	84
CSDPN.....	85



• **FIXAÇÃO POR GRAMPO**

CSKPR 86

CSSPR 87

• **FIXAÇÃO POR GRAMPO-PARAFUSO**

CTCPN 88

CTDPR 89

CTFPR 90

CTGPR 91

CTTPR 92

CKJNR 93

• **FIXAÇÃO RÍGIDA**

DCBNR 94

DCKNR 95

• **FIXAÇÃO POR ALAVANCA**

DCLNR 96

DCSNR 97

• **FIXAÇÃO POR GRAMPO-PARAFUSO**

DDJNR 98

DDHNR 99





• ***FIXAÇÃO RÍGIDA***

DDNNN.....	100
DRDNN.....	101
DRSNR.....	102
DSBNR.....	103
DSDNN.....	104
DSKNR.....	105
DSSNR.....	106
DTFNR.....	107
DTGNR.....	108
DTJNR.....	109
DTTNR.....	110
DVJNR.....	111
DVPNR.....	112
DVVNN.....	113
DWLNR.....	114



SUORTES PARA TORNEAMENTO EXTERNO

SISTEMA DE FIXAÇÃO

C - Fixação por Grampo

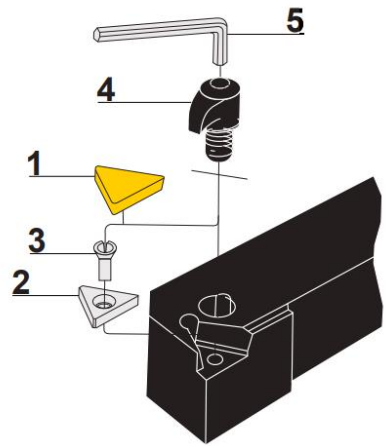
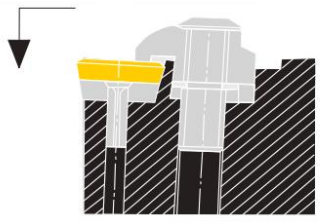

- 1 Pastilha
- 2 Calço
- 3 Rebite
- 4 Conj. Grampo/Parafuso
- 5 Chave Allen



D - Fixação Rígida

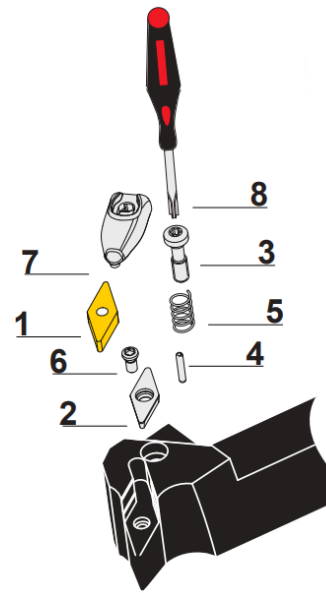

- 1 Pastilha
- 2 Calço
- 3 Parafuso Grampo
- 4 Pino
- 5 Mola
- 6 Parafuso Calço
- 7 Grampo
- 8 Chave Torx



M - Fixação Dupla por Pino e Grampo

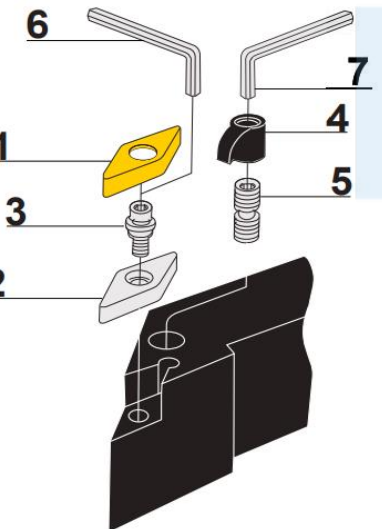
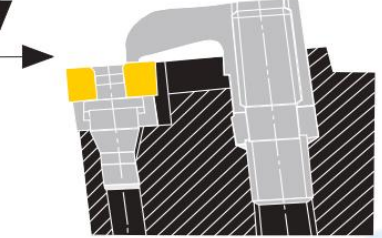

- 1 Pastilha
- 2 Calço
- 3 Pino do calço
- 4 Grampo
- 5 Parafuso do grampo
- 6 Chave Allen 1
- 7 Chave Allen 2

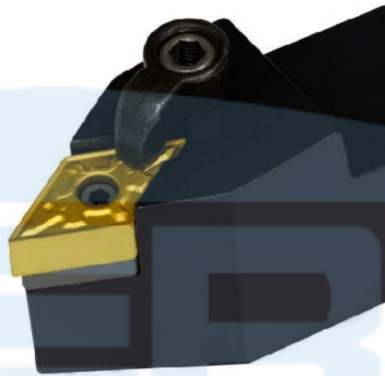

M - Fixação por Cunha-Grampo

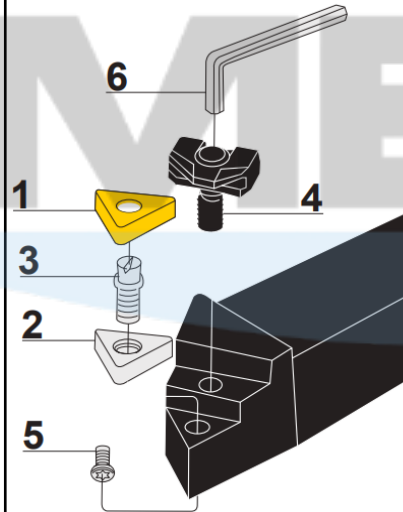
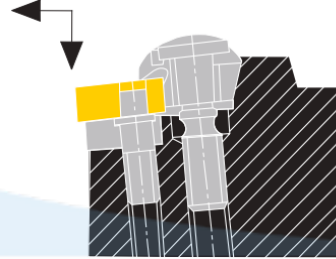

- 1 Pastilha
- 2 Calço
- 3 Rebite
- 4 Conj. Grampo/Parafuso
- 5 Parafuso do pino
- 6 Chave Allen



P - Fixação por Alavanca

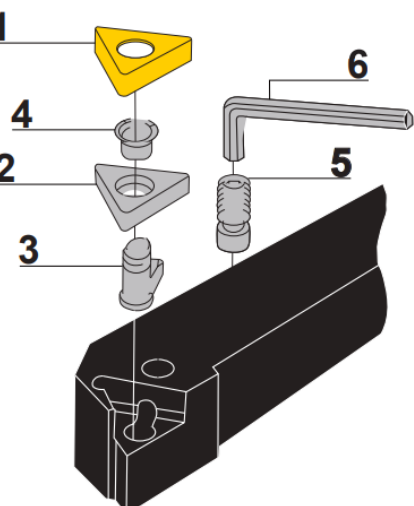

- 1 Pastilha
- 2 Calço
- 3 Alavanca
- 4 Rebite
- 5 Parafuso
- 6 Chave Allen



S - Fixação por Parafuso-Torx

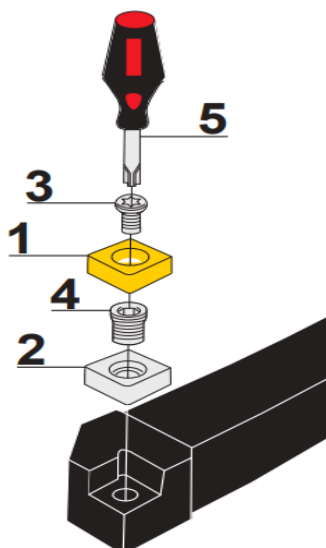

- 1 Pastilha
- 2 Calço
- 3 Parafuso da Pastilha
- 4 Parafuso do Calço
- 5 Chave Torx

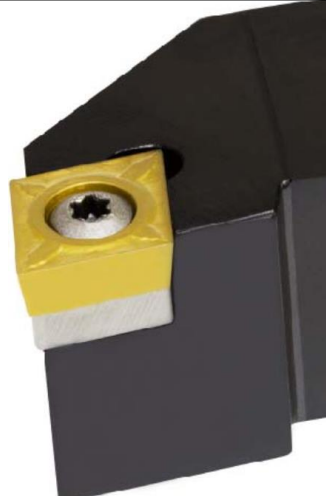



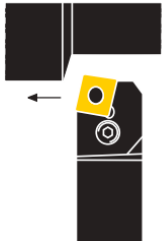
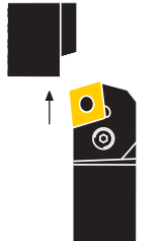
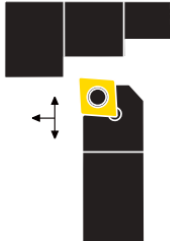
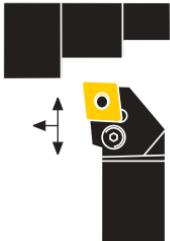

SUORTES INTERCAMBIÁVEIS PARA TORNEAMENTO EXTERNO

TORNEAMENTO

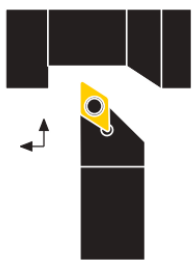
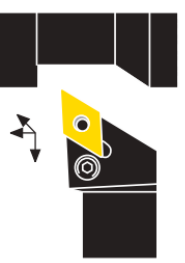
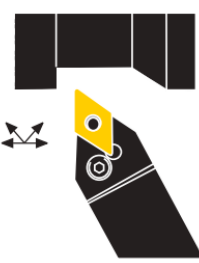
FIXAÇÃO POR ALAVANCA

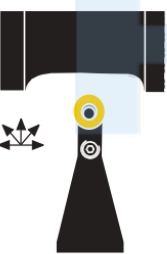
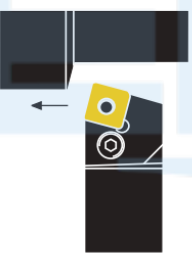
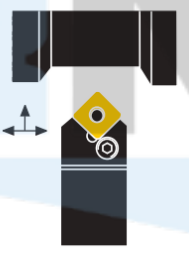
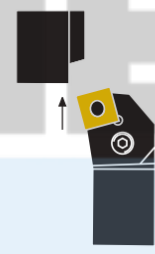

	PCBNR 	PCKNR 	PCLCR 	PCLNR 
Ângulo de ataque	75°	75°	95°	95°

PDACR 	PDJNR 	PDNNN 	PRGCR 	PRGNR 
91°	93°	62°30'	-	-

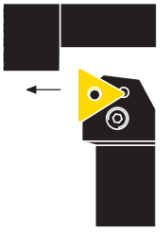
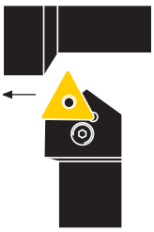
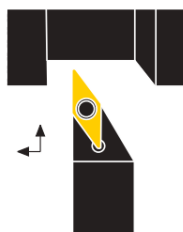
N176.39 	PSBNR 	PSDNN 	PSKNR 	PSSNR[®] 
-	75°	45°	75°	45°

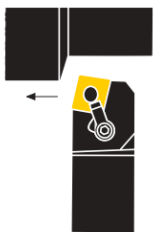

PTFNR 	PTGNR 	PTTNR 	PVACR 
91°	91°	60°	91°

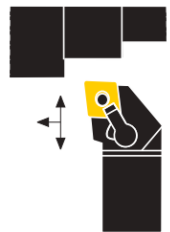
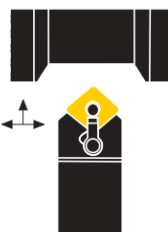

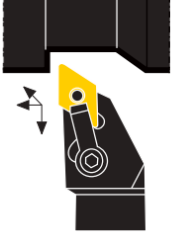
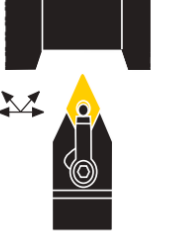
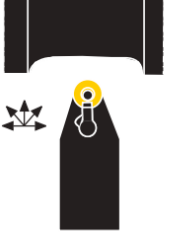

FIXAÇÃO POR PINO E GRAMPO

	MCBNR 	MCKNR 	MCLNR 	MCDNN 
Ângulo de ataque	75°	75°	95°	40°

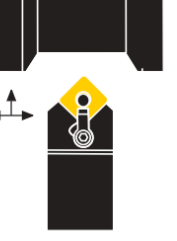
SUORTES INTERCAMBIÁVEIS PARA TORNEAMENTO EXTERNO

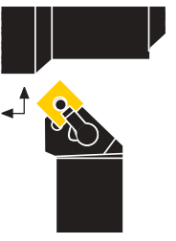
TORNEAMENTO

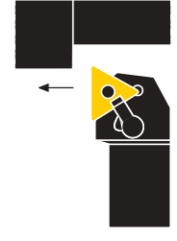
MDJNR 	MDNNN 	MRDNN 	MSBNR 	MSDNN 
93°	62°30'	-	75°	45°

MSKNR 	MSSNR 	MTFNR 	MTGNR 	MTSNR 
75°	45°	91°	91°	45°

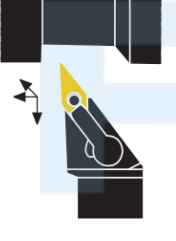
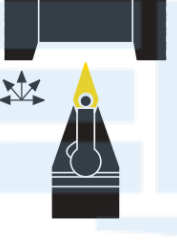
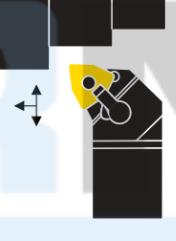
MVJNR 	MVVNN 	MWLNR-M2 
93°	72°30'	95°

FIXAÇÃO POR CUNHA-GRAMPO

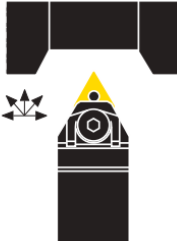
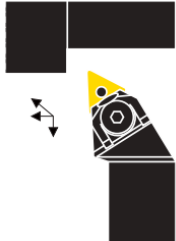
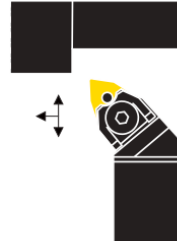
	MTENN 	MTJNR 	MWLNR 
Ângulo de ataque	60°	93°	95°

FIXAÇÃO POR PARAFUSO TORX

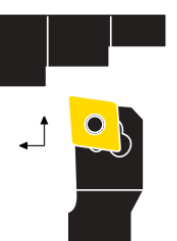
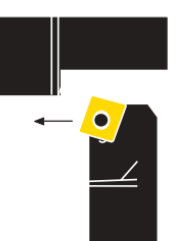
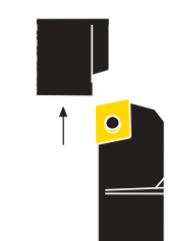
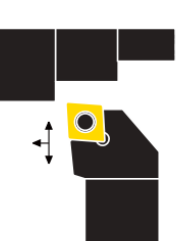
	SCACR 	SCBCR 	SCKCR 	SCLCR 
Ângulo de ataque	93°	75°	75°	95°

SUORTES INTERCAMBIÁVEIS PARA TORNEAMENTO EXTERNO

TORNEAMENTO

<p>SCSCR</p> <p>45°</p>	<p>SDACR</p> <p>90°</p>	<p>SDHCR</p> <p>107°30'</p>	<p>SDJCR</p> <p>93°</p>	<p>SDNCN</p> <p>55°</p>
--------------------------------	--------------------------------	------------------------------------	--------------------------------	--------------------------------

<p>SRDCN</p> <p>-</p>	<p>SRDCR</p> <p>-</p>	<p>SRSCR</p> <p>-</p>	<p>SSDCN</p> <p>-</p>	<p>SSSCR</p> <p>45°</p>
------------------------------	------------------------------	------------------------------	------------------------------	--------------------------------

<p>STDRCR</p> <p>45°</p>	<p>STFCR</p> <p>91°</p>	<p>STGCR</p> <p>91°</p>	<p>STTCR</p> <p>60°</p>	<p>SVACR®</p> <p>90°</p>
---------------------------------	--------------------------------	--------------------------------	--------------------------------	---------------------------------

FIXAÇÃO POR PARAFUSO TORX

<p>SVHBR</p> <p>107°30'</p>	<p>SVHCR-R2</p> <p>107°30'</p>	<p>SVJBR SVJCR</p> <p>93°</p>	<p>SVVBN SVVCN</p> <p>72°30'</p>	<p>SVPBR SVLBR</p> <p>95°</p>
------------------------------------	---------------------------------------	--	---	--





<p>SVXCR</p> <p>112°</p>	<p>SXCNN</p> <p>-</p>
---------------------------------	------------------------------



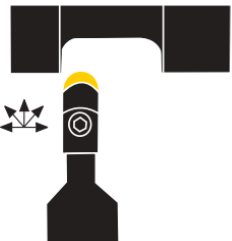
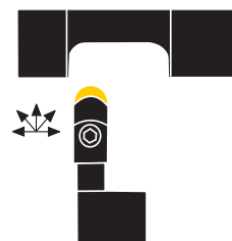
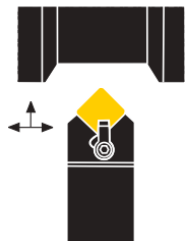
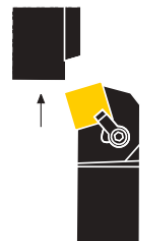

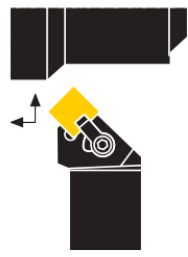
SUportes intercambiáveis para torneamento externo

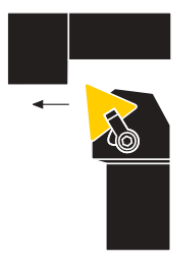

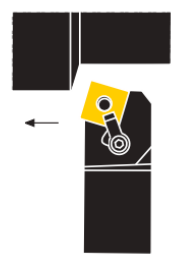
TORNEAMENTO

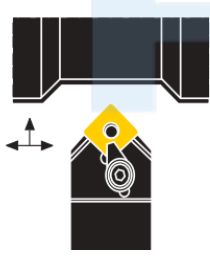
FIXAÇÃO POR GRAMPO

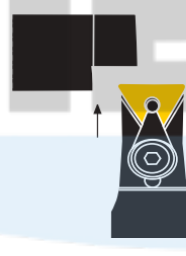

	CRDCN 	CRDCR 	CSDNN 	CSKNR 
Ângulo de ataque	-	-	45°	75°

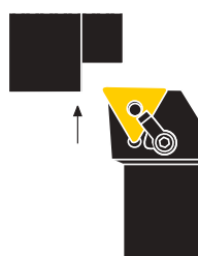
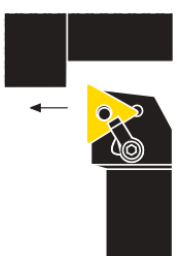
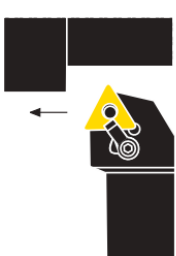
CSSNR 	CTFNR 	CTJNR 	CXCNN 	CSBPR 
45°	91°	93°	90°	75°

CSDPN 	CSKPR 	CSSPR 	CTCPN 	CTDPR 
45°	75°	45°	90°	45°

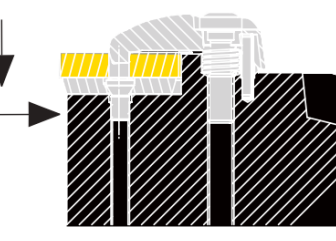
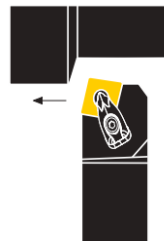

CTFPR 	CTGPR 	CTTPR 	CKJNR 
91°	91°	60°	93°

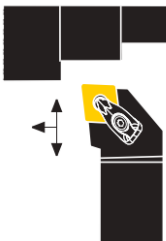
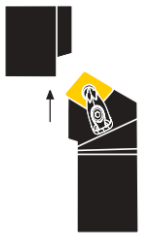
FIXAÇÃO RÍGIDA

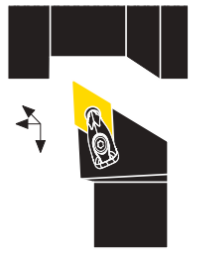
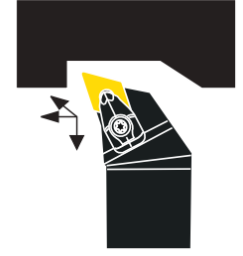
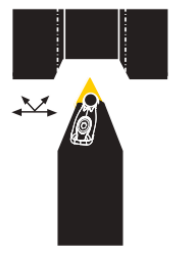

	DCBNR 	DCKNR 	DCLNR 	DCSNR 
Ângulo de ataque	75°	75°	95°	45°

SUORTES INTERCAMBIÁVEIS PARA TORNEAMENTO EXTERNO

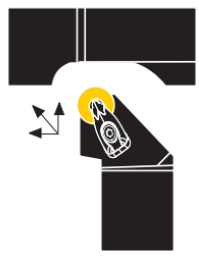
TORNEAMENTO

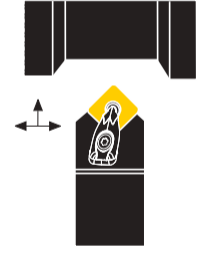
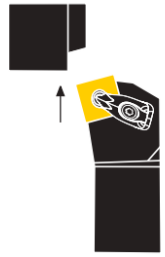
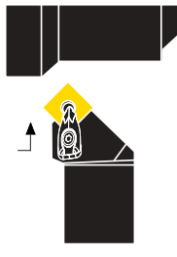
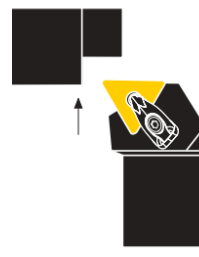
DDJNR  93°	DDHNR  -	DDNNN  -	DRDNN  -	DRSNR  -
--	--	---	--	--

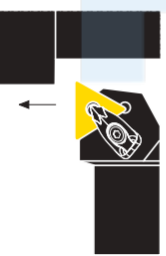
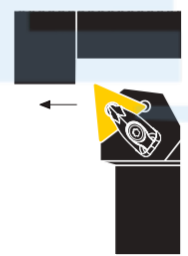
DSBNR  75°	DSDNN  45°	DSKNR  75°	DSSNR  45°	DTFNR  91°
---	---	--	---	---

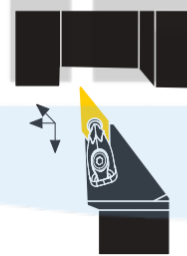
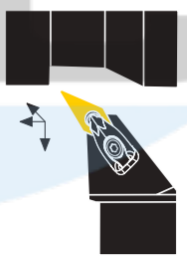
DTGNR  91°	DTJNR  93°	DTTNR  60°	DVJNR  93°	DVPNR  117°30'
--	--	---	--	--

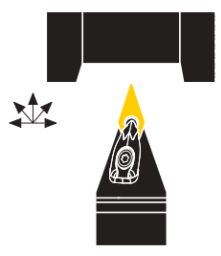
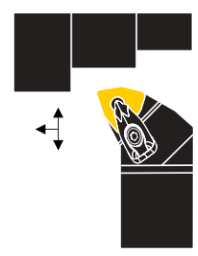
DVVNN  72°30'	DWLNR  95°
---	--



SISTEMA DE FIXAÇÃO POR ALAVANCA

PCBNR

Suporte para tornear 75° com pastilha negativa 80° para aproveitamento do ângulo de 100°











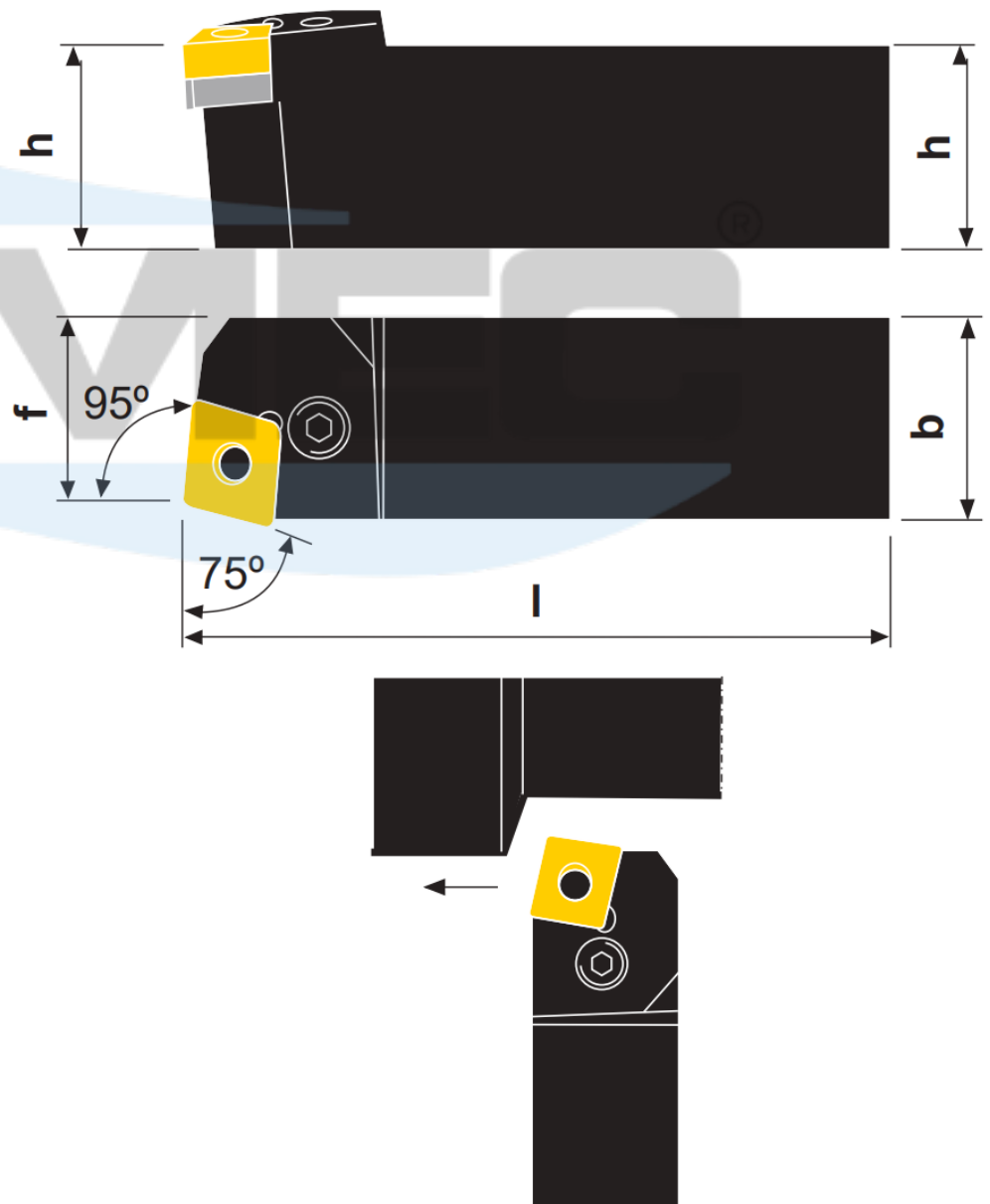
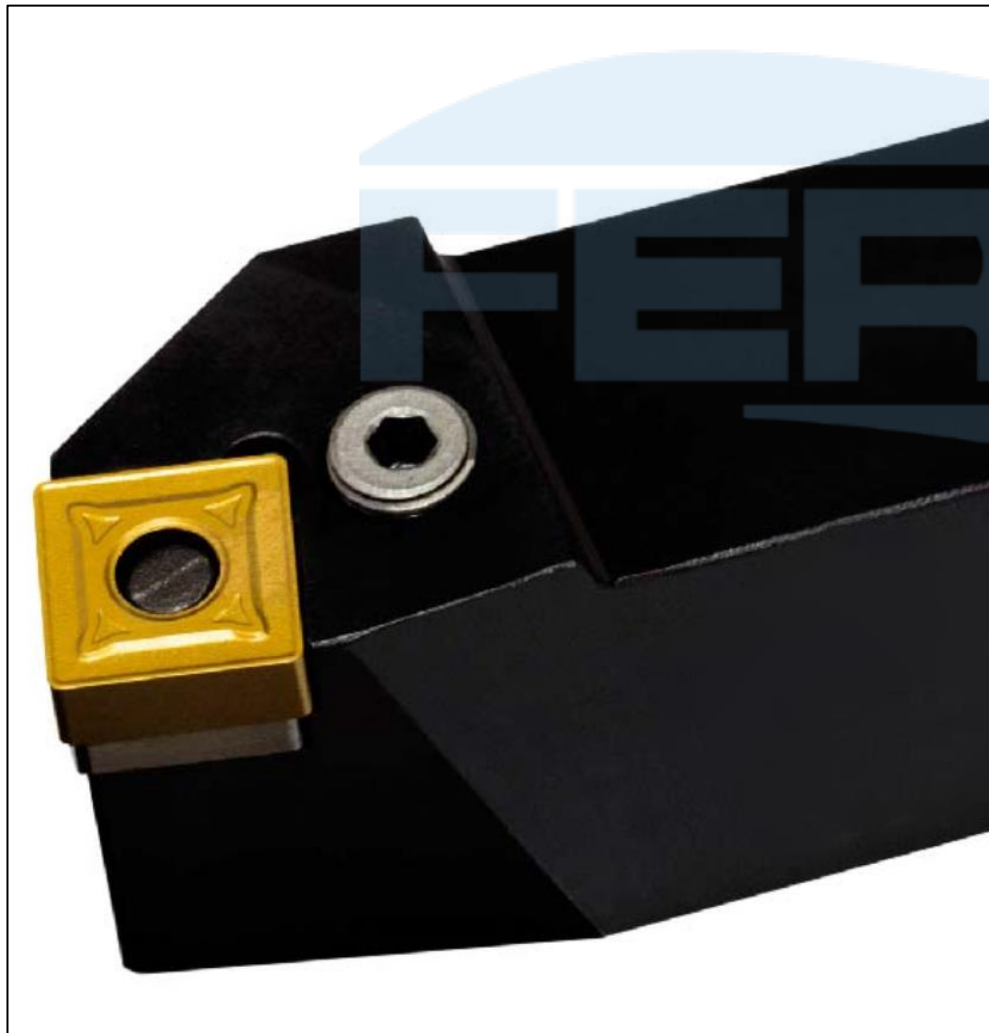

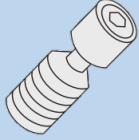
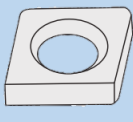
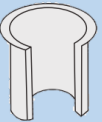
Ilustração na versão direita

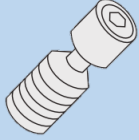
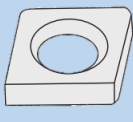
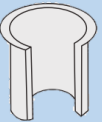
Produtos	Dimensões (mm)				Pastilha	Acessórios				
	h	b	l	f			 Alavanca	 Parafuso	 Calço	 Rebite
PCBNR/L 2020 K12	20	20	125	20	CN_1204					
PCBNR/L 2525 M12	25	25	150	25						
PCBNR/L 3225 P12	32	25	170	32						
PCBNR/L 2525 M16	25	25	150	25	CN_1606					
PCBNR/L 3232 P16	32	32	170	32						
PCBNR/L 3232 P19	32	32	170	32	CN_1906					
PCBNR/L 4040 S19	40	40	250	40						

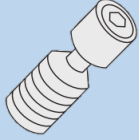
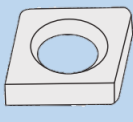
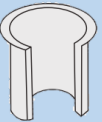
SISTEMA DE FIXAÇÃO POR ALAVANCA

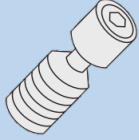
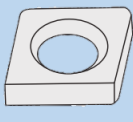
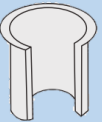
PCKNR

Suporte para facear 75° com pastilha negativa 80° para aproveitamento do ângulo de 100°











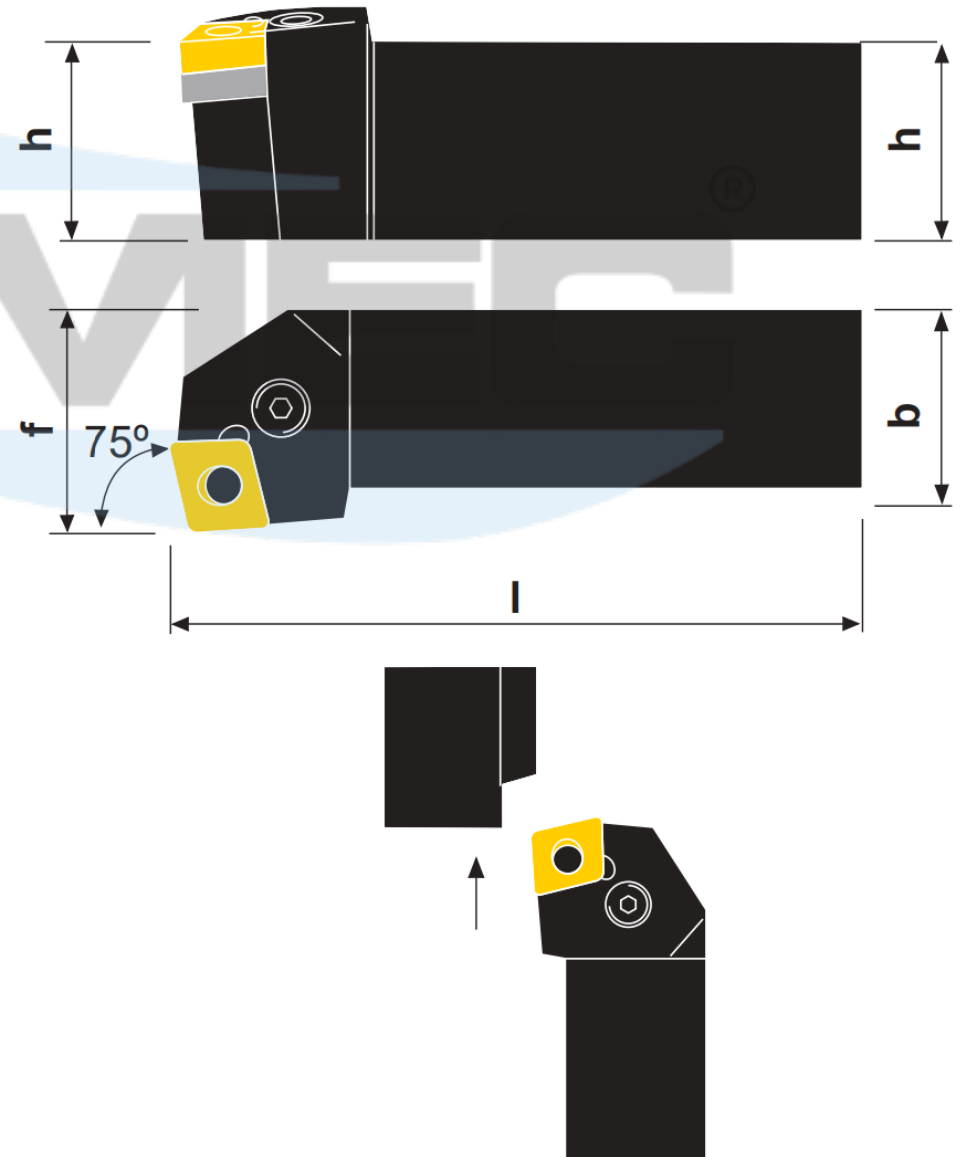

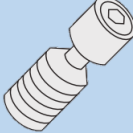
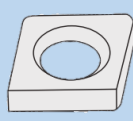
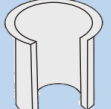
Ilustração na versão direita

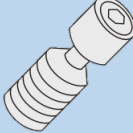
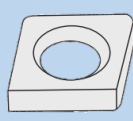
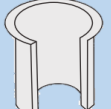
Produtos	Dimensões (mm)				Pastilha	Acessórios				
	h	b	l	f			 Alavanca	 Parafuso da Alavanca	 Calço	 Rebite
PCKNR/L 2020 K12	20	20	125	17	CN_1204					
PCKNR/L 2525 M12	25	25	150	22						
PCKNR/L 3225 P12	32	25	170	22						
PCKNR/L 2525 M16	25	25	150	22	CN_1606					
PCKNR/L 3232 P16	32	32	170	27						
PCKNR/L 3232 P19	32	32	170	27	CN_1906					
PCKNR/L 4040 S19	40	40	250	35						

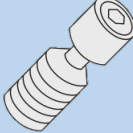
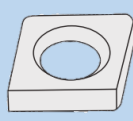
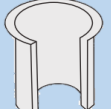
SISTEMA DE FIXAÇÃO POR ALAVANCA

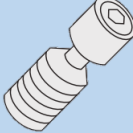
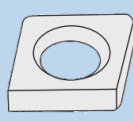
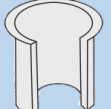
PCLCR

Suporte para torneiar e facear 95° com pastilha negativa 80°





Ilustração na versão direita

Produtos	Dimensões (mm)				Pastilha 	Acessórios			
	h	b	l	f					
PCLCR/L 2020 K12	8	8	150	8	CC_0602	SL PI-2	SL LV-2	SR 10400611	C - 2,0
PCLCR/L 2525 M12	10	10	150	10,2					
PCLCR/L 3225 P12	12	12	150	12,2					
PCLCR/L 2525 M16	16	16	150	16,2					
PCLCR/L 3232 P16	10	10	150	12,2	CC_09T3	SL PI-3	SL LV-3	SR 10400150	C - 2,5
PCLCR/L 3232 P19	12	12	150	12,2					
PCLCR/L 4040 S19	16	16	150	16,2					

SISTEMA DE FIXAÇÃO POR ALAVANCA

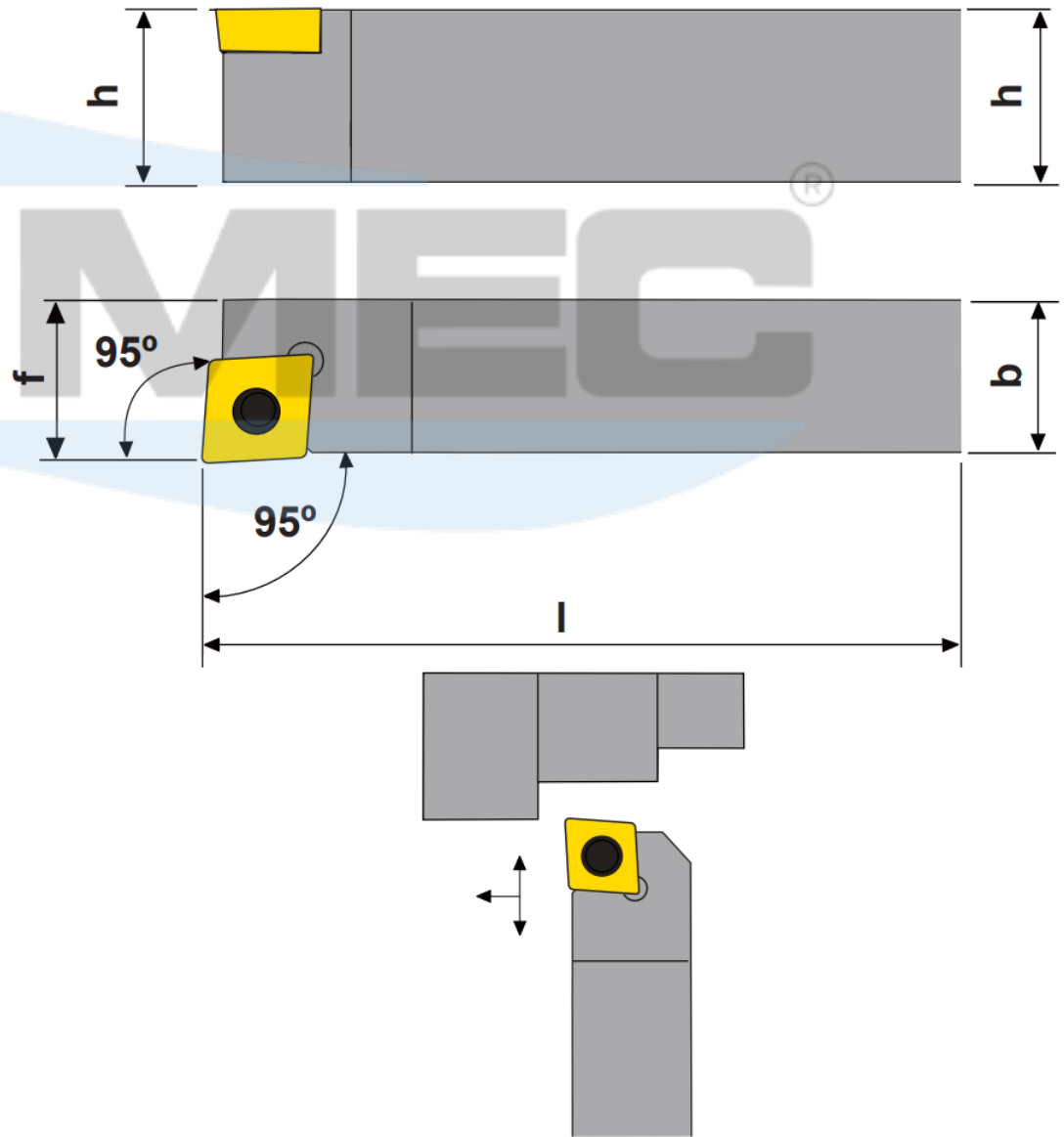
PCLNR

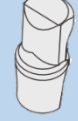
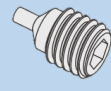
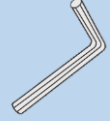
Suporte para torneiar e facear 95° com pastilha negativa 80°



Ilustração na versão direita

Produtos	Dimensões (mm)				Pastilha	Acessórios				
	h	b	l	f		Alavanca	Parafuso	Calço	Rebite	Chave Allen
PCLNR/L 1616 H09	16	16	100	20	CN_0903	174.3-840M	174.3-820M	5322 230-02	174.3-863	C - 2,5
PCLNR/L 2020 K09	20	20	125	25						
PCLNR/L 2525 M09	25	25	150	32						
PCLNR/L 2020 K12	20	20	125	25	CN_1204	174.3-841M	174.3-821	171.31-850M	174.3-861	C - 3,0
PCLNR/L 2525 M12	25	25	150	32						
PCLNR/L 3225 P12	32	25	170	32						
PCLNR/L 2525 M16	25	25	150	32	CN_1606	438.3-840	438.3-831	171.31-852	174.3-864	C - 3,0
PCLNR/L 3232 P16	32	32	170	40						
PCLNR/L 3232 P19	32	32	170	40	CN_1906	174.3-842M	174.3-822M	171.31-851M	174.3-862	C - 4,0
PCLNR/L 4040 S19	40	40	250	50						
PCLNR/L 5050 T19	50	50	300	60						

SISTEMA DE FIXAÇÃO POR ALAVANCA

PDACR

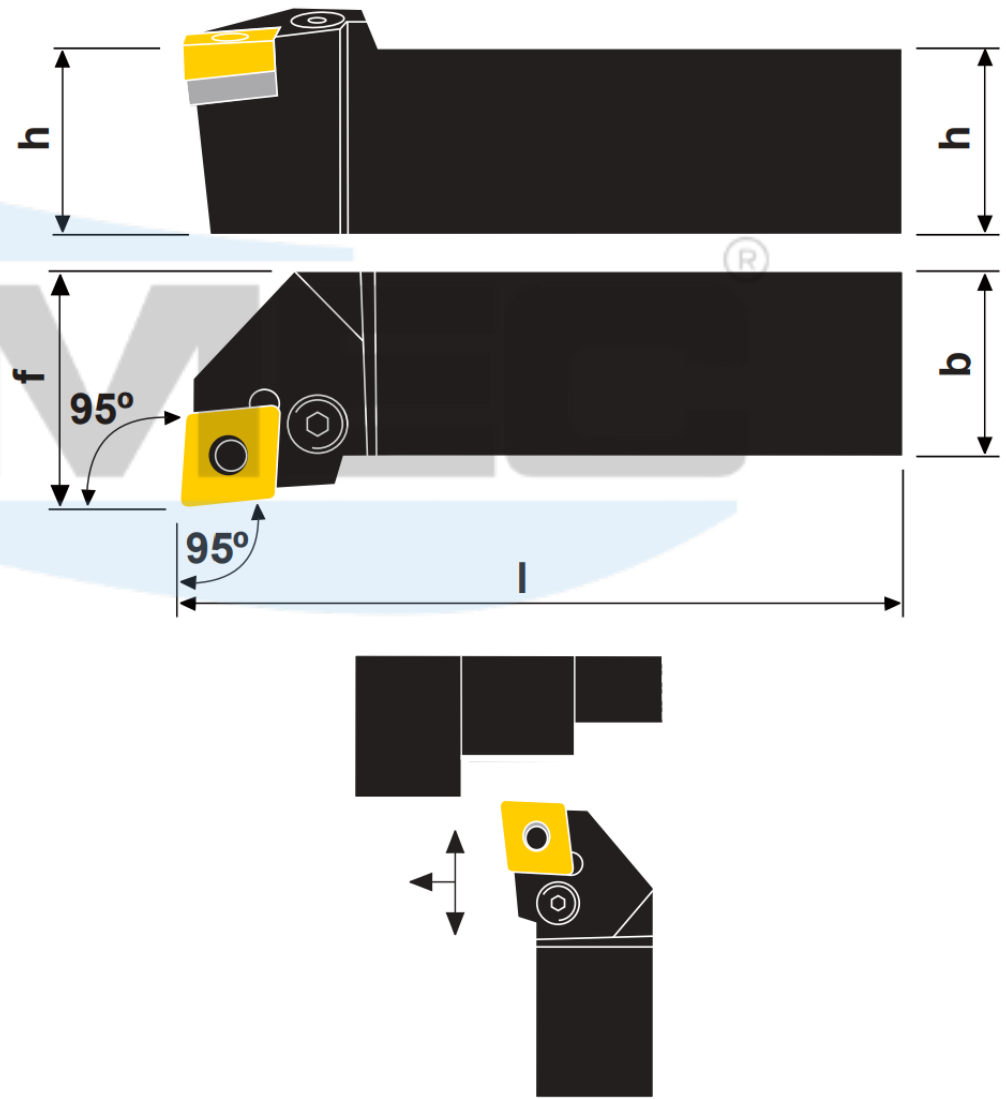
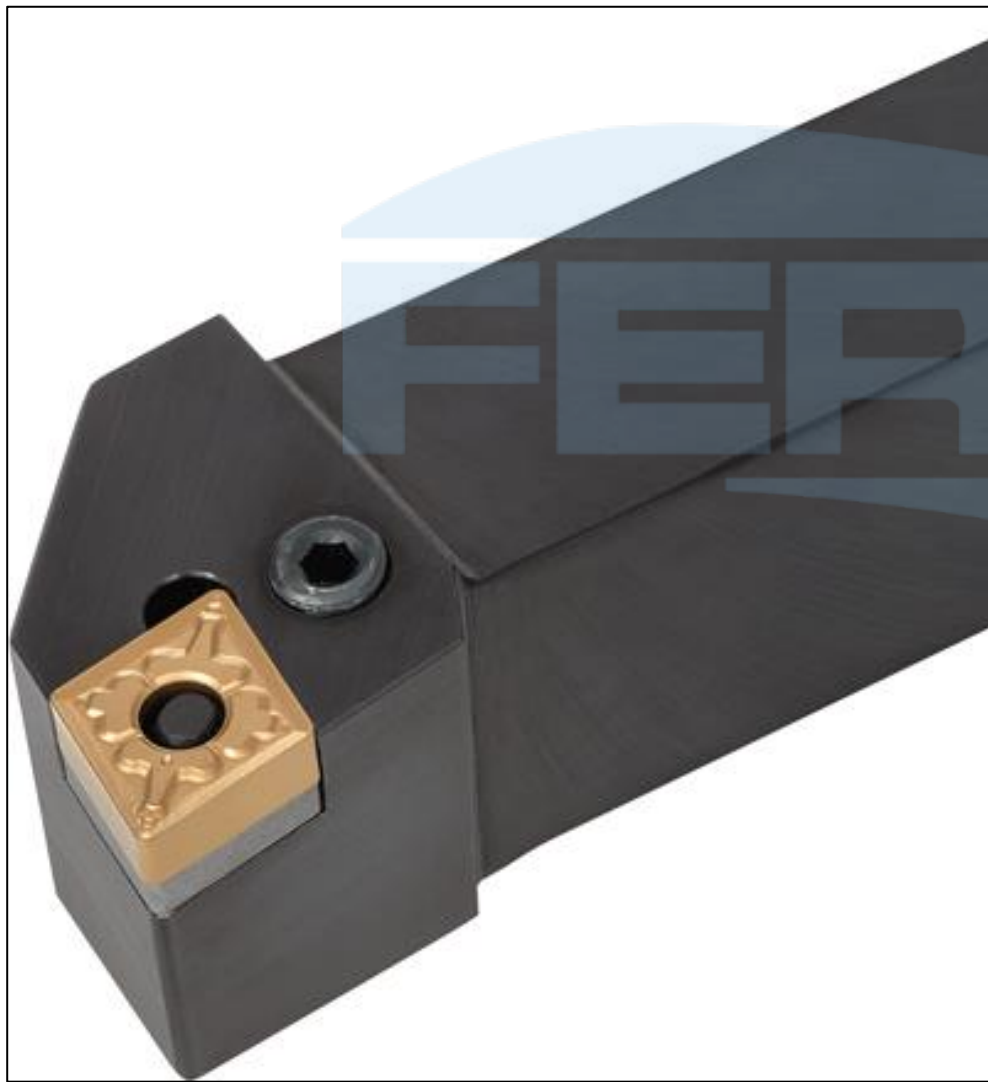
Suporte para torneiar 91° com pastilha negativa 55°



Ilustração na versão direita

Produtos	Dimensões (mm)				Pastilha	Acessórios			
	h	b	l	f		Alavanca	Parafuso da Alavanca	Pino	Chave Allen
PDACR/L 0808M-07S	8	8	150	8	DC_0702	SL LV-2	SR 10400611	SL PI-2	C - 2,0
PDACR/L 1010M-07S	10	10	150	10,2					
PDACR/L 1212M-07S	12	12	150	12,2					
PDACR/L 1616M-07S	16	16	150	16,2					
PDACR/L 1012M-11S	10	10	150	12,2	DC_11T3	SL LV-3	SR 10400150	SL PI-3	C - 2,5
PDACR/L 1212M-11S	12	12	150	12,2					
PDACR/L 1616M-11S	16	16	150	16,2					

SISTEMA DE FIXAÇÃO POR ALAVANCA

PDJNR

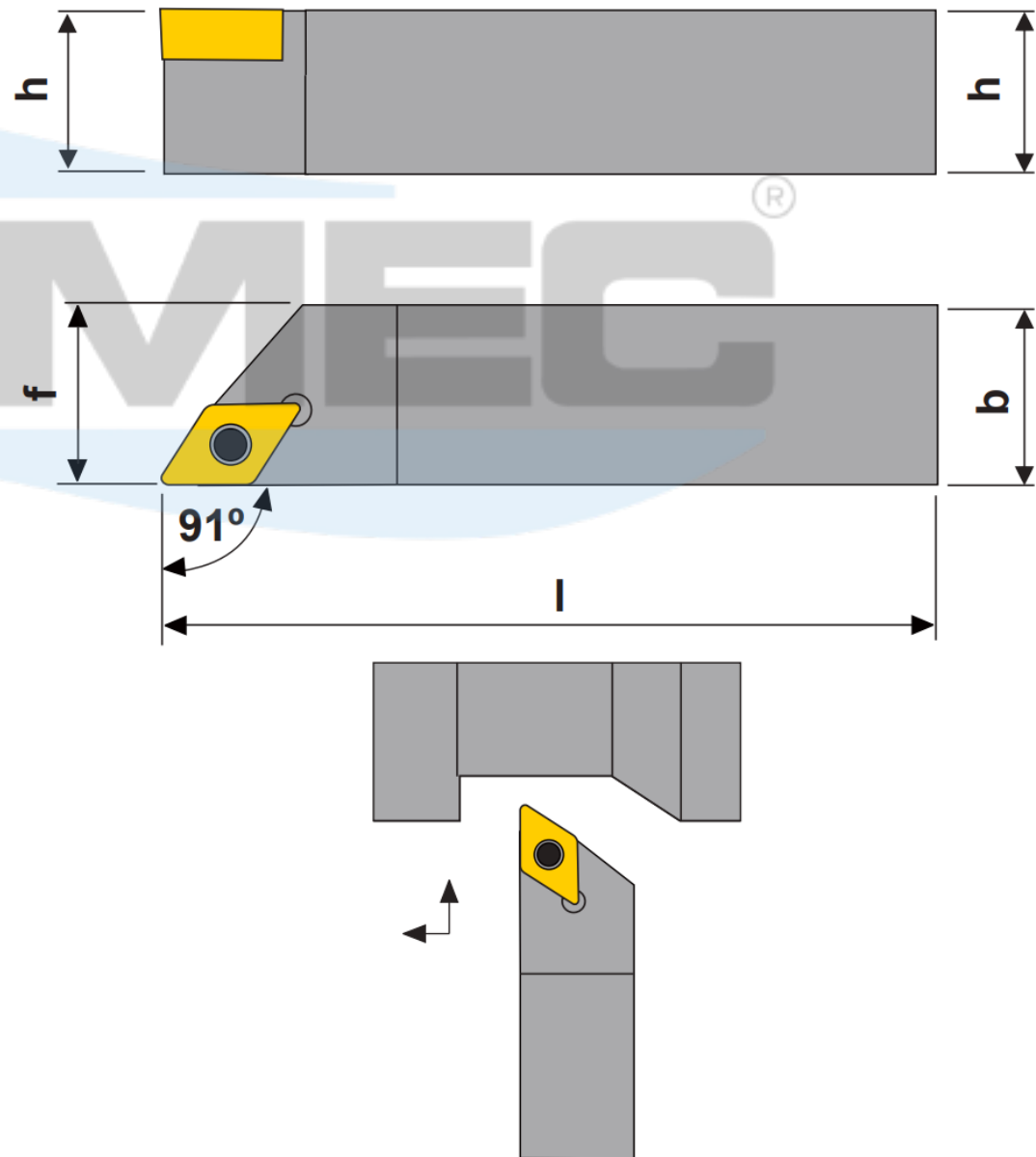
Suporte para torneiar 93° com pastilha negativa 55°



Ilustração na versão direita

Produtos	Dimensões (mm)				Pastilha	Acessórios				
	h	b	l	f		Alavanca	Parafuso	Calço	Rebite	Chave Allen
PDJNR/L 1616 H11	16	16	100	20	DN_1104	5432 001-01	174.3-820M	5322 255-01	174.3-860	C - 2,5
PDJNR/L 2020 K11	20	20	125	25						
PDJNR/L 2525 M11	25	25	150	32						
PDJNR/L 2020 K15	20	20	125	25	DN_1506	174.3-847M	174.3-830	171.35-851M	174.3-861	C - 3,0
PDJNR/L 2525 M15	25	25	150	32						
PDJNR/L 3225 P15	32	25	170	32						
PDJNR/L 3232 P15	32	32	170	40						
PDJNR/L 4025 R15	40	25	200	28,7						
PDJNR/L 5032 R15	50	32	200	35						

SISTEMA DE FIXAÇÃO POR ALAVANCA

PDNNN

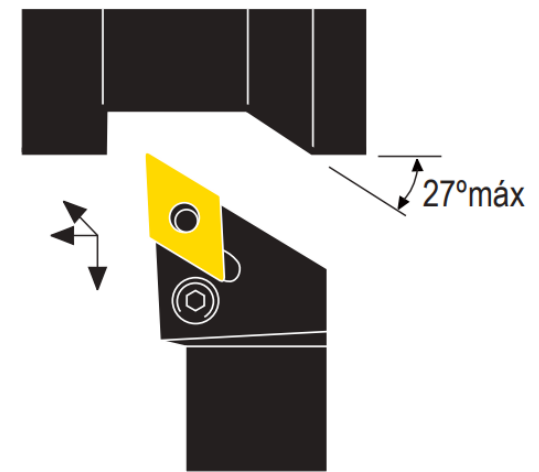
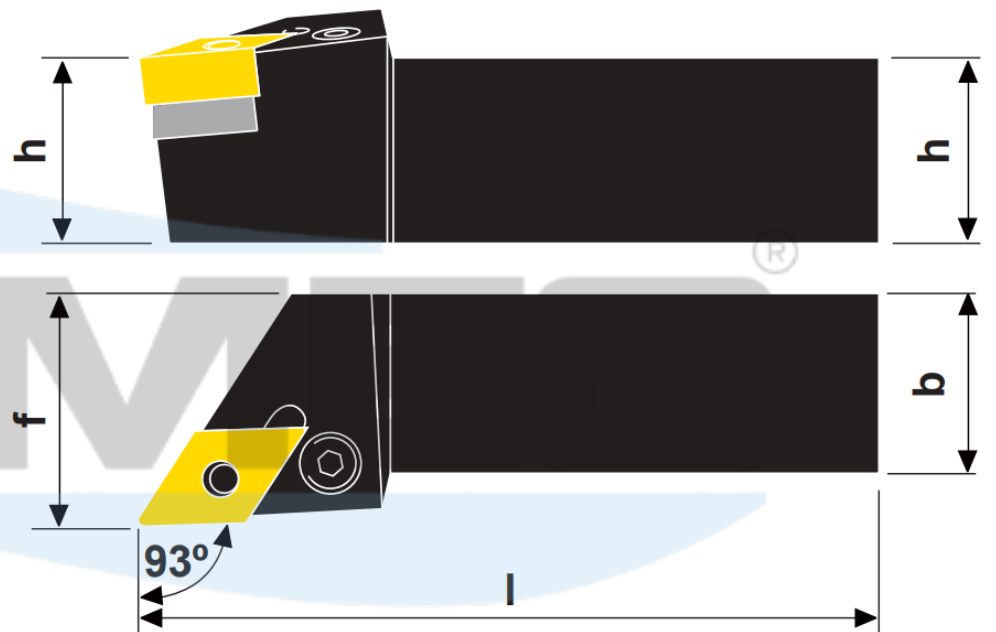
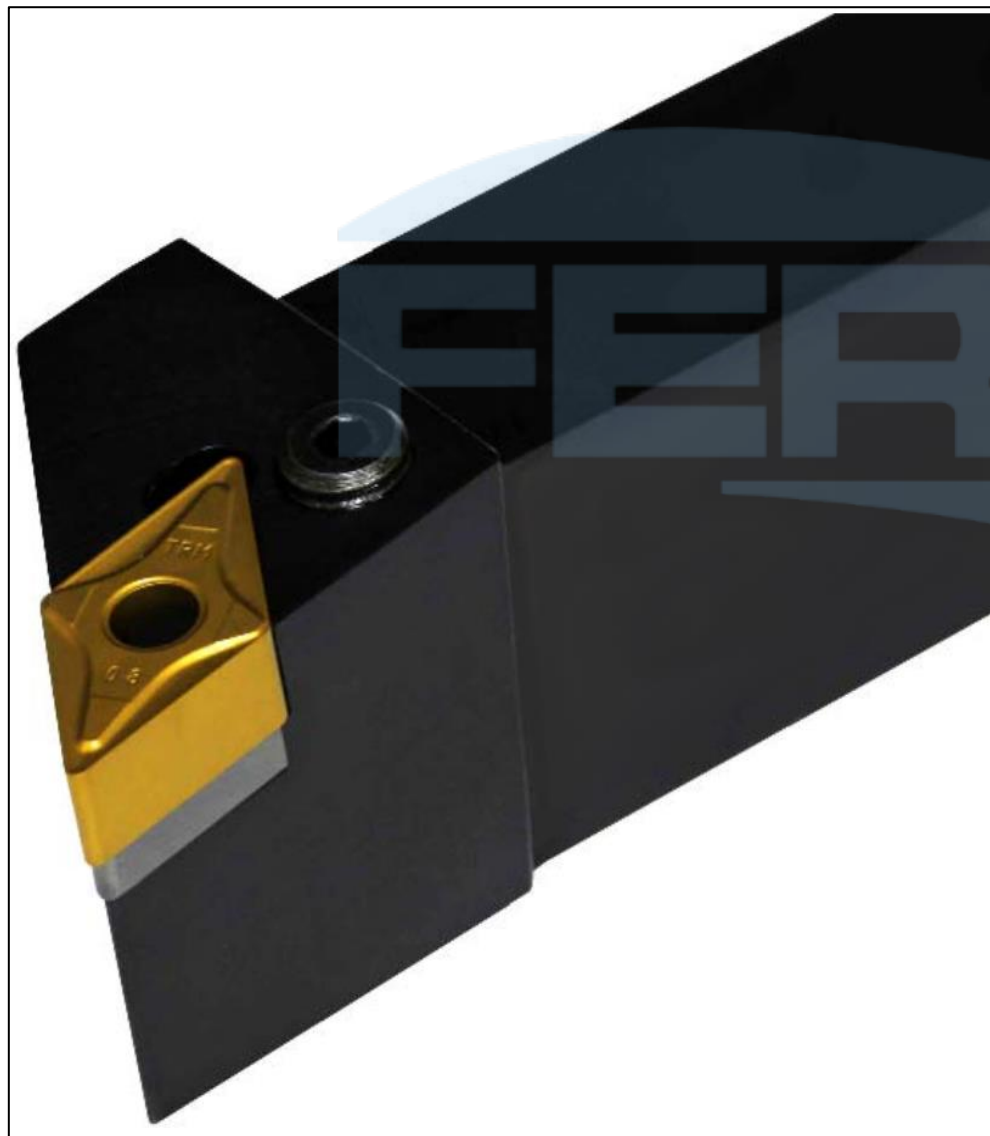
Suporte neutro para torneiar $62^{\circ}30'$ com pastilha negativa 55°





Ilustração na versão direita

Produtos	Dimensões (mm)				Pastilha	Acessórios				
	h	b	l	f		Alavanca	Parafuso	Calço	Rebite	Chave Allen
PDNNN 1616 H11	16	16	100	8,0	 DN_1104	 5432 001-01	 174.3-820M	 5322.255-01	 174.3-860	 C - 2,5
PDNNN 2020 K11	20	20	125	10						
PDNNN 2525 M11	25	25	150	12,5						
PDNNN 2020 K15	20	20	125	10	DN_1506	174.3-847M	174.8-830	171.35-850M	174.3-861	C - 3,0
PDNNN 2525 M15	25	25	150	12,5						
PDNNN 3232 P15	32	25	170	12,5						
PDNNN 4025 P15	40	25	170	12,5						

SISTEMA DE FIXAÇÃO POR ALAVANCA

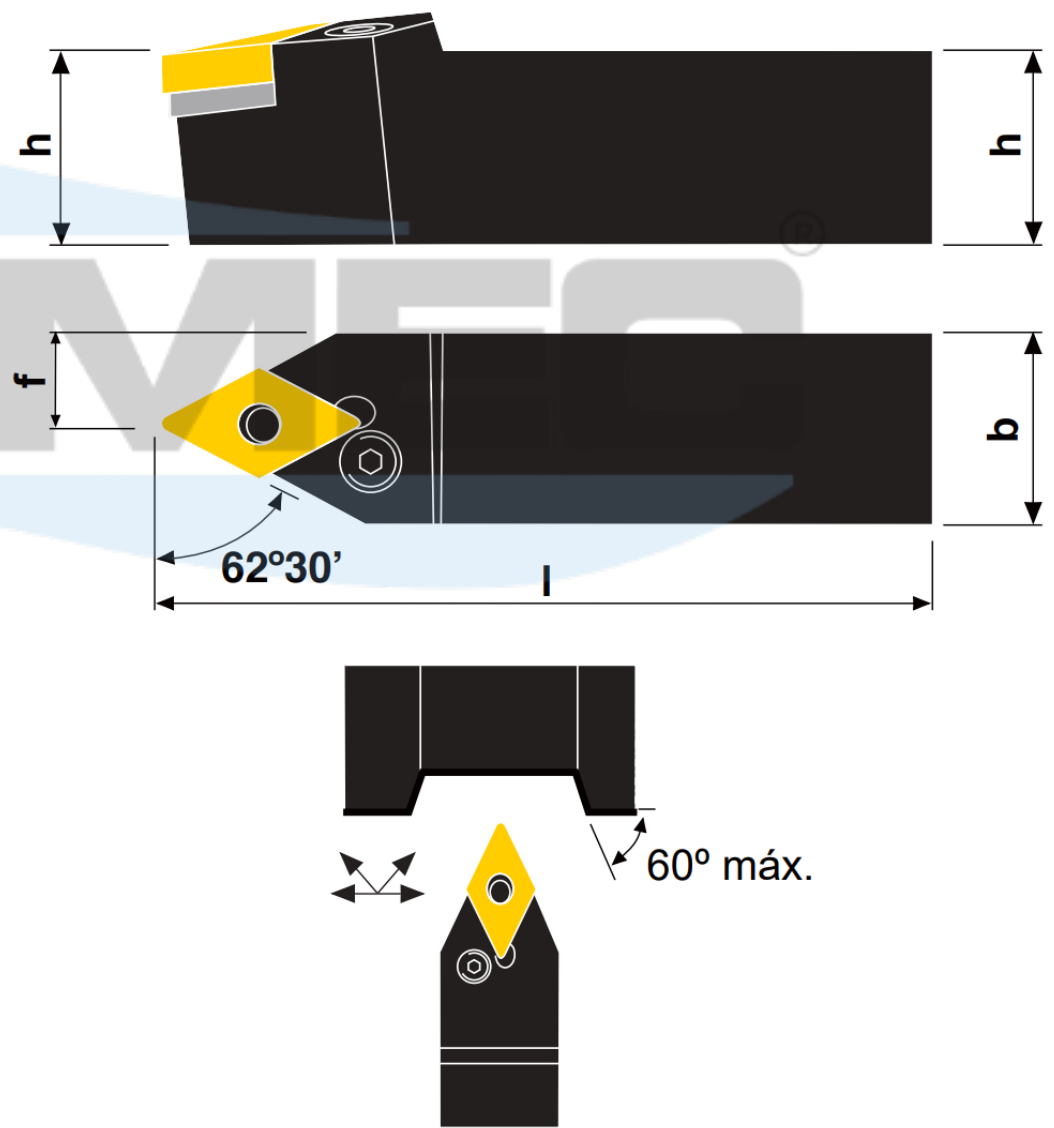
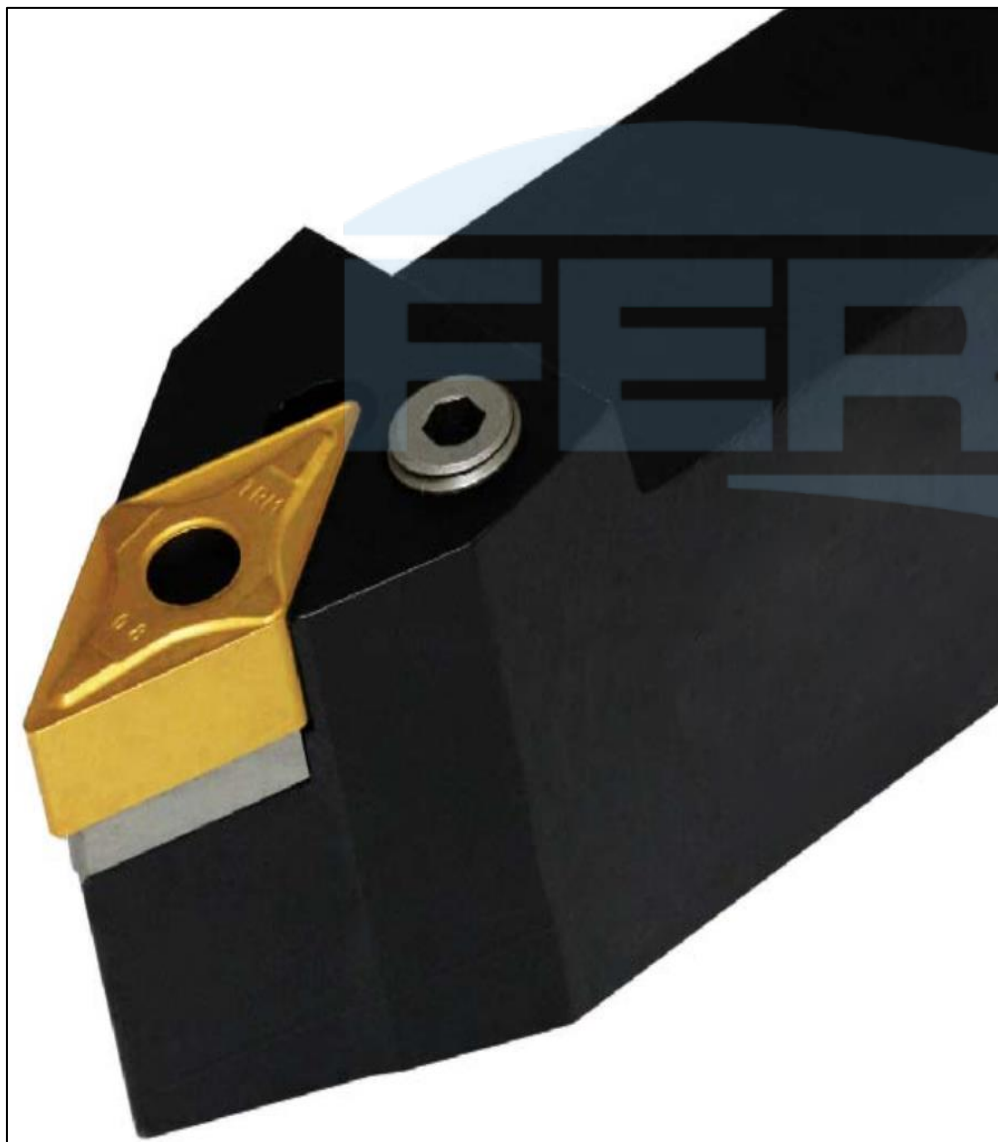
PRGCR

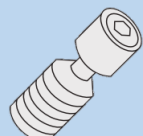
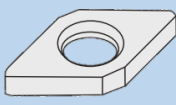
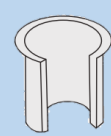
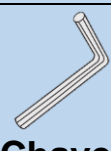
Suporte para torneiar e facear com pastilha positiva redonda







Ilustração na versão direita

Produtos	Dimensões (mm)				Pastilha	Acessórios				
	h	b	l	f			 Alavanca	 Parafuso	 Calço	 Rebite
PRGCR/L 2020 K10	20	20	125	25	RC_100300	176.39-840	174.3-834	176.39-850	174.3-860	C - 5/64
PRGCR/L 2525 M10	25	25	150	32						
PRGCR/L 2020 K12	20	20	125	25	RC_120400	5432 005-01	174.3-820M	176.39-851	174.3-863	C - 2,5
PRGCR/L 2525 M12	25	25	150	32						
PRGCR/L 3225 P12	32	25	170	32						
PRGCR/L 2525 M16	25	25	150	32	RC_160600	176.39-842	174.3-833	176.39-852	174.3-867	C - 3,0
PRGCR/L 3225 P16	32	25	170	32						
PRGCR/L 3232 P20	32	32	170	40	RC_200600	176.39-843	174.3-825	176.39-853	174.3-864	C - 3,0
PRGCR/L 4040 S25	40	40	250	50	RC_250700	176.39-844	174.3-832	176.39-854	174.3-862	C - 4,0
PRGCR/L 5050 T25	50	50	300	60						
PRGCR/L 5050 T32	50	50	300	60	RC_320900	176.39-845	174.3-827	176.39-855	174.3-865	C - 5,0

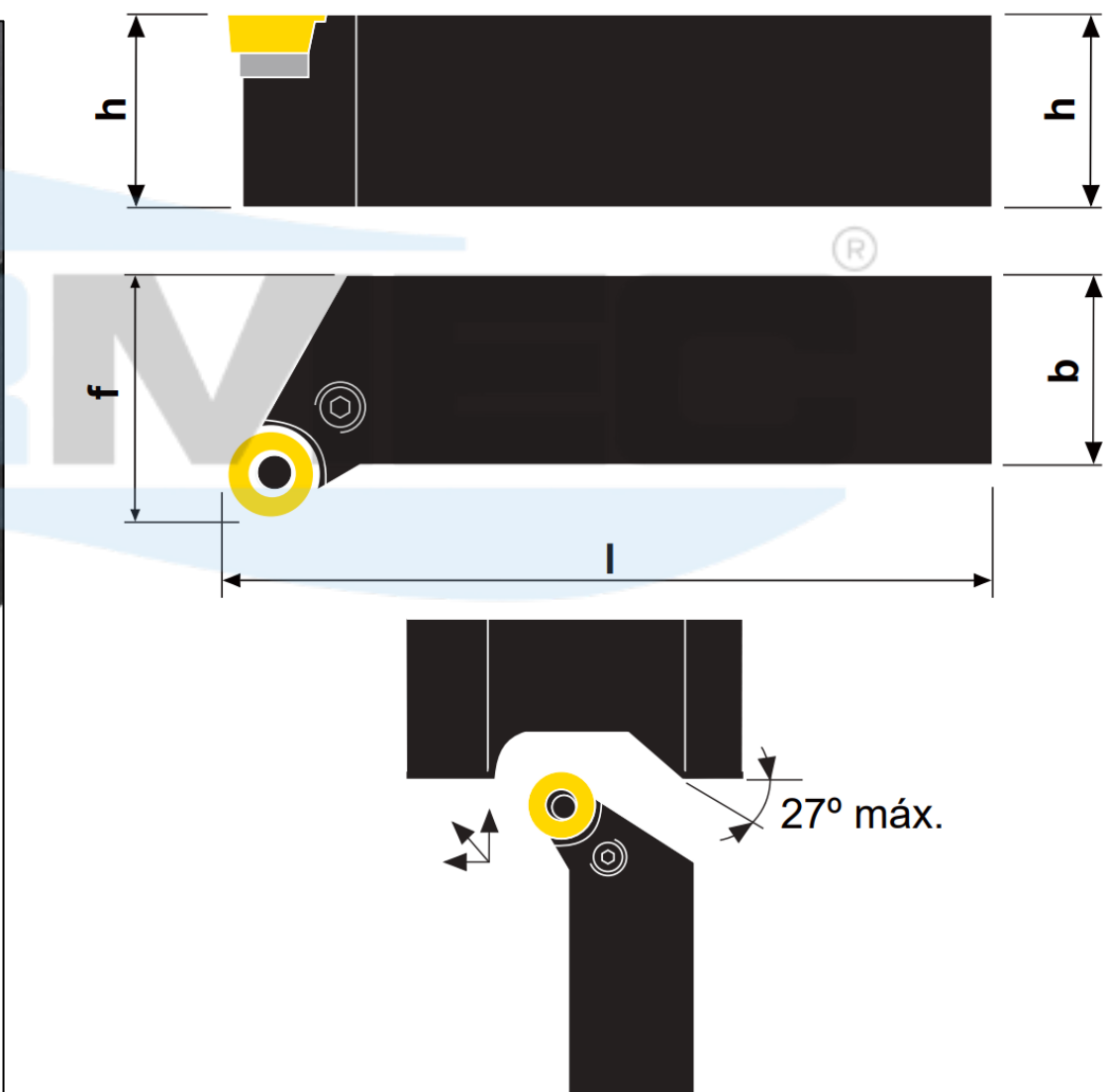
SISTEMA DE FIXAÇÃO POR ALAVANCA

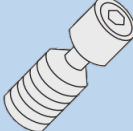
PRGNR

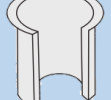
Suporte para torneiar e facear com pastilha negativa redonda











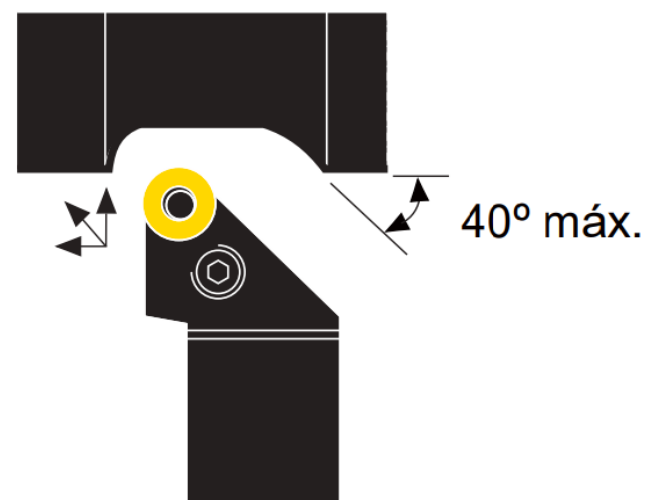
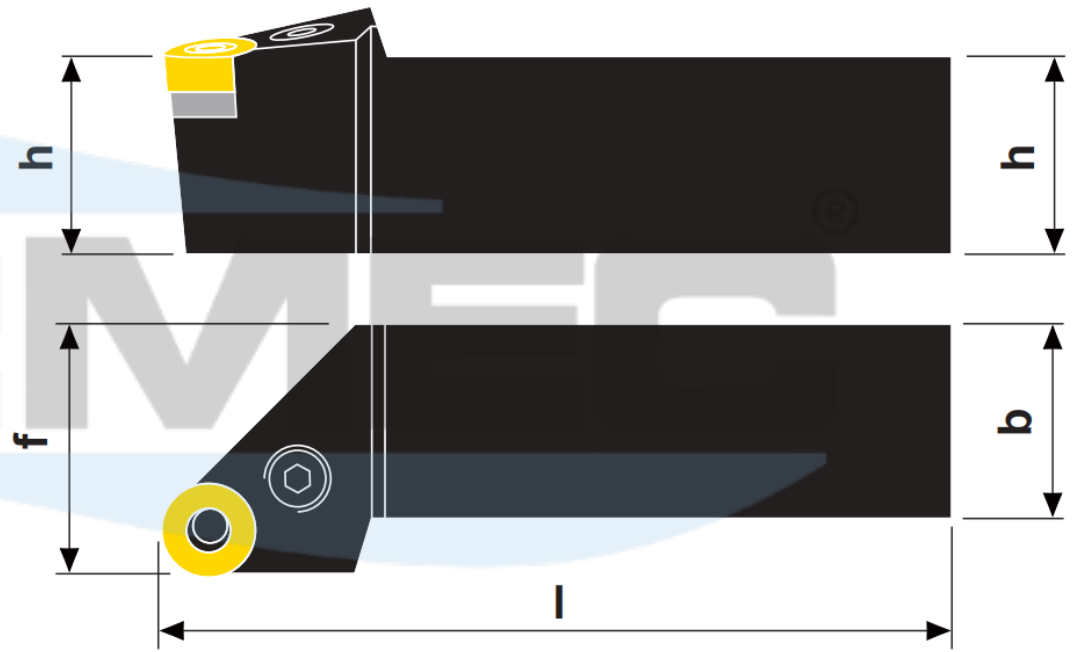
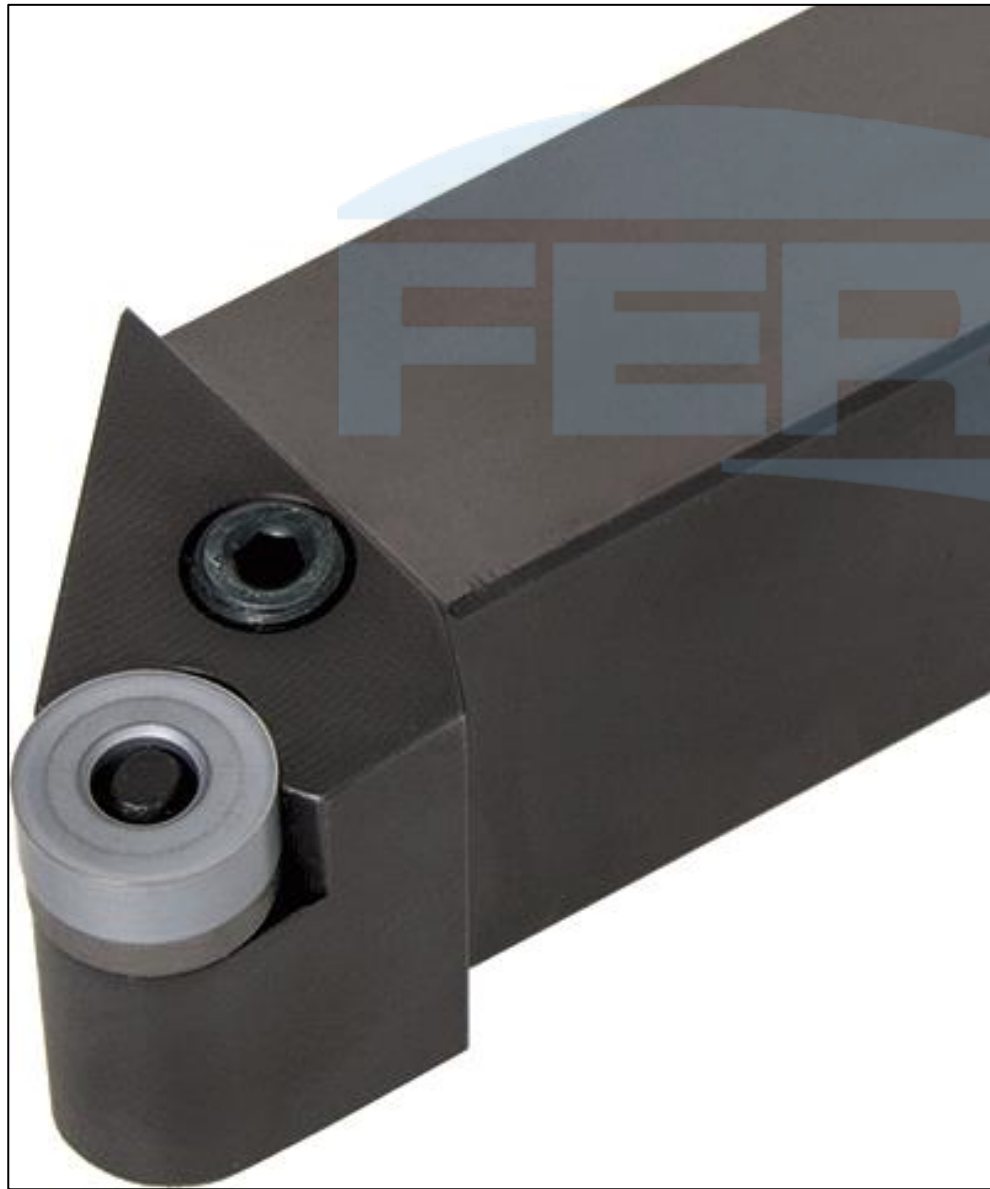

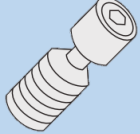

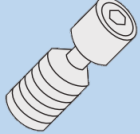

Ilustração na versão direita

Produtos	Dimensões (mm)				Pastilha	Acessórios				
	h	b	l	f			 Alavanca	 Parafuso	 Calço	 Rebite
PRGNR/L 2020 K12	20	20	125	25	RN_120400	 Alavanca	 Parafuso	 Calço	 Rebite	 Chave Allen
PRGNR/L 2525 M12	25	25	150	32						
PRGNR/L 3232 P15	32	32	170	40	RN_150600	 Alavanca	 Parafuso	 Calço	 Rebite	 Chave Allen
PRGNR/L 3232 P19	32	32	170	40	RN_190600	174.3-843M	174.3-825	176.6-854M	174.3-864	C - 3,0
PRGNR/L 4040 S25	40	40	250	50	RN_250900	174.3-842M	174.3-822M	176.6-852M	174.3-862	C - 4,0
						174.3-844M	174.3-827	176.6-853M	174.3-865	C - 5,0

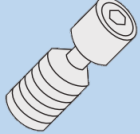
SISTEMA DE FIXAÇÃO POR ALAVANCA

N176.39

Suporte neutro para torneiar e facear com pastilha positiva redonda





Ilustração na versão direita

Produtos	Dimensões (mm)				Pastilha	Acessórios				
	h	b	l	f			 Alavanca	 Parafuso	 Calço	 Rebite
N176.39 - 2020-10	20	20	150	15	RC_100300	176.39-840	174.3-834	176.39-850	174.3-860	C - 5/64
N176.39 - 2525-10	25	25	150	17,5						
N176.39 - 2020-12	20	20	150	16	RC_120400	5432 005-01	174.3-820M	176.39-851	174.3-863	C - 2,5
N176.39 - 2525-12	25	25	150	18,5						
N176.39 - 3225-12	32	25	180	18,5						
N176.39 - 3225-16	32	25	180	20,5	RC_160600	176.39-842	174.3-833	176.39-852	174.3-867	C - 2,5
N176.39 - 3232-20	32	32	180	26	RC_200600	176.39-843	174.3-825	176.39-853	174.3-864	C - 3,0
N176.39 - 4040-20	40	40	300	30						
N176.39 - 4040-25	40	40	300	32,5	RC_250700	176.39-844	174.3-832	176.39-854	174.3-862	C - 4,0
N176.39 - 5050-25	50	50	350	37,5						
N176.39 - 5050-32	50	50	350	41	RC_320900	176.39-845	174.3-827	176.39-855	174.3-865	C - 5,0

SISTEMA DE FIXAÇÃO POR ALAVANCA

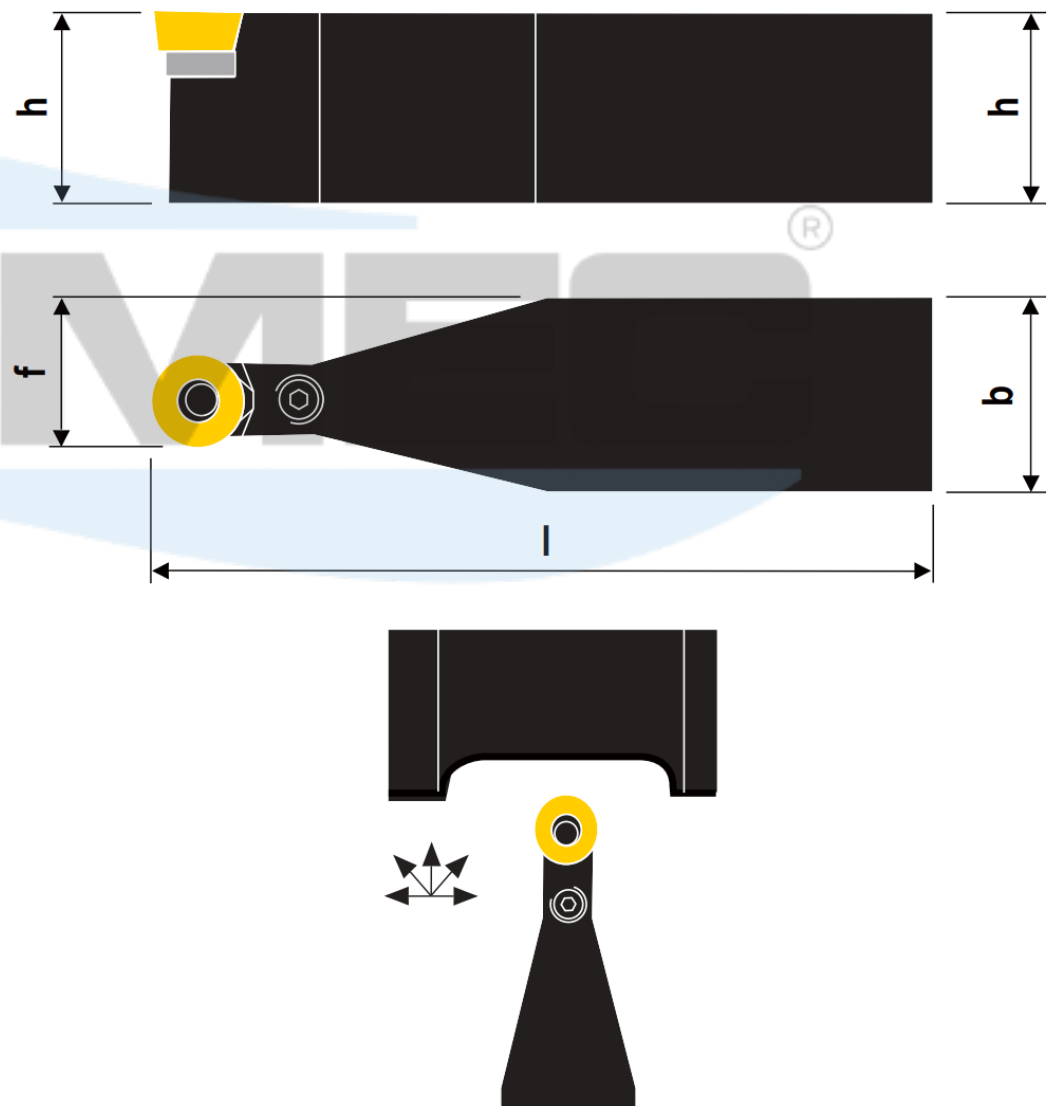
PSBNR

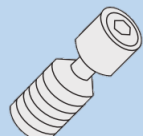
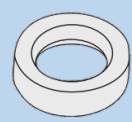
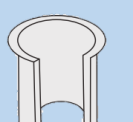
Suporte para tornear 75° com pastilha negativa quadrada







Ilustração na versão direita

Produtos	Dimensões (mm)				Pastilha	Acessórios				
	h	b	l	f						
PSBNR/L 1616 H09	16	16	100	13	SN_0903	174.3-840M	174.3-820M	174.3-850	174.3-863	C - 2,5
PSBNR/L 2020 K09	20	20	125	17						
PSBNR/L 2020 K12	20	20	125	17	SN_1204	174.3-841M	174.3-821	174.3-851M	174.3-861	C - 3,0
PSBNR/L 2525 M12	25	25	150	22						
PSBNR/L 3225 P12	32	25	170	22	SN_1506	438.3-840	438.3-831	174.3-857	174.3-864	C - 3,0
PSBNR/L 2525 M15	25	25	150	22						
PSBNR/L 3232 P15	32	32	170	27	SN_1906	174.3-842M	174.3-822M	174.3-852M	174.3-862	C - 4,0
PSBNR/L 3232 P19	32	32	170	27						
PSBNR/L 4040 S19	40	40	250	35	SN_2507	174.3-844M	174.3-827	174.3-853M	174.3-865	C - 5,0
PSBNR/L 4040 S25	40	40	250	35						
PSBNR/L 5050 T25	50	50	300	43						

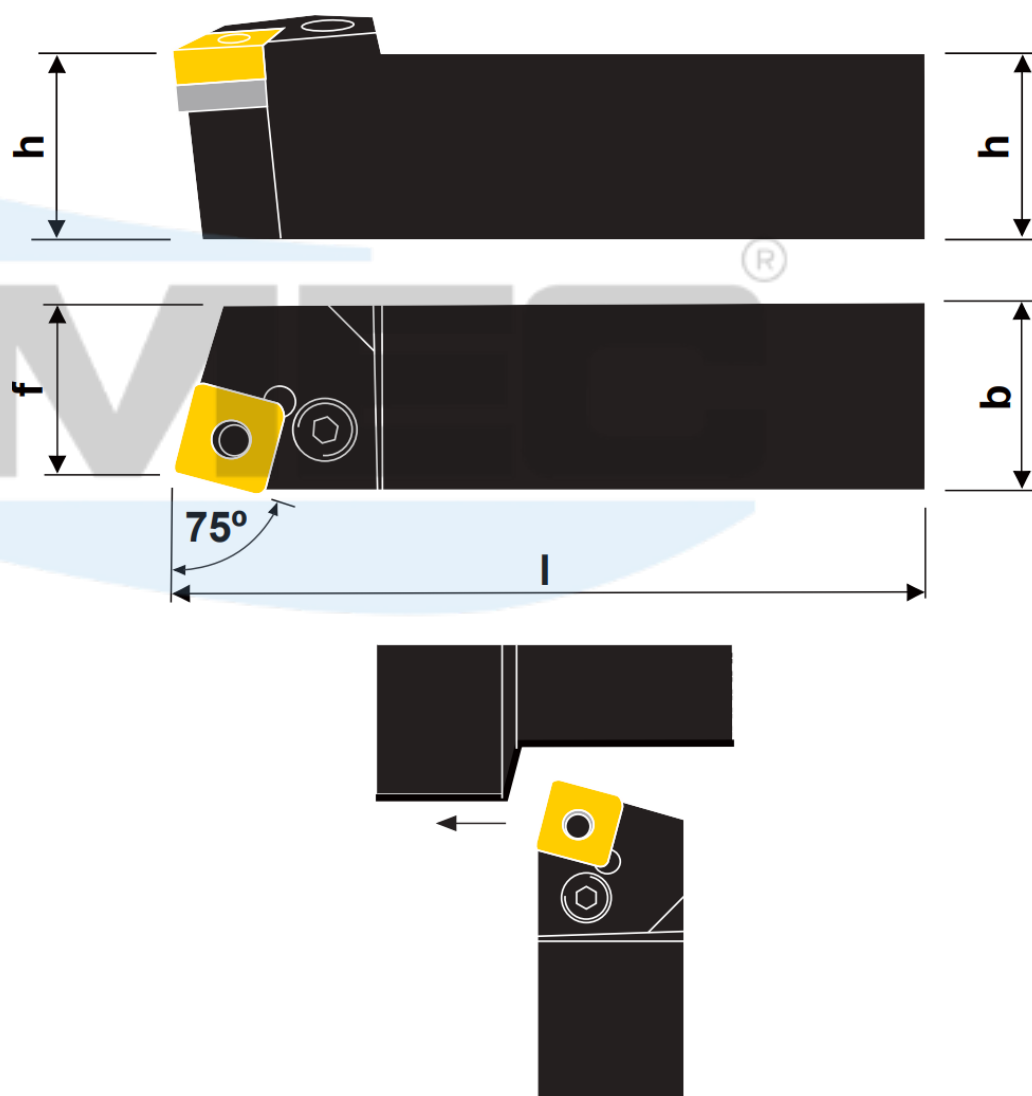
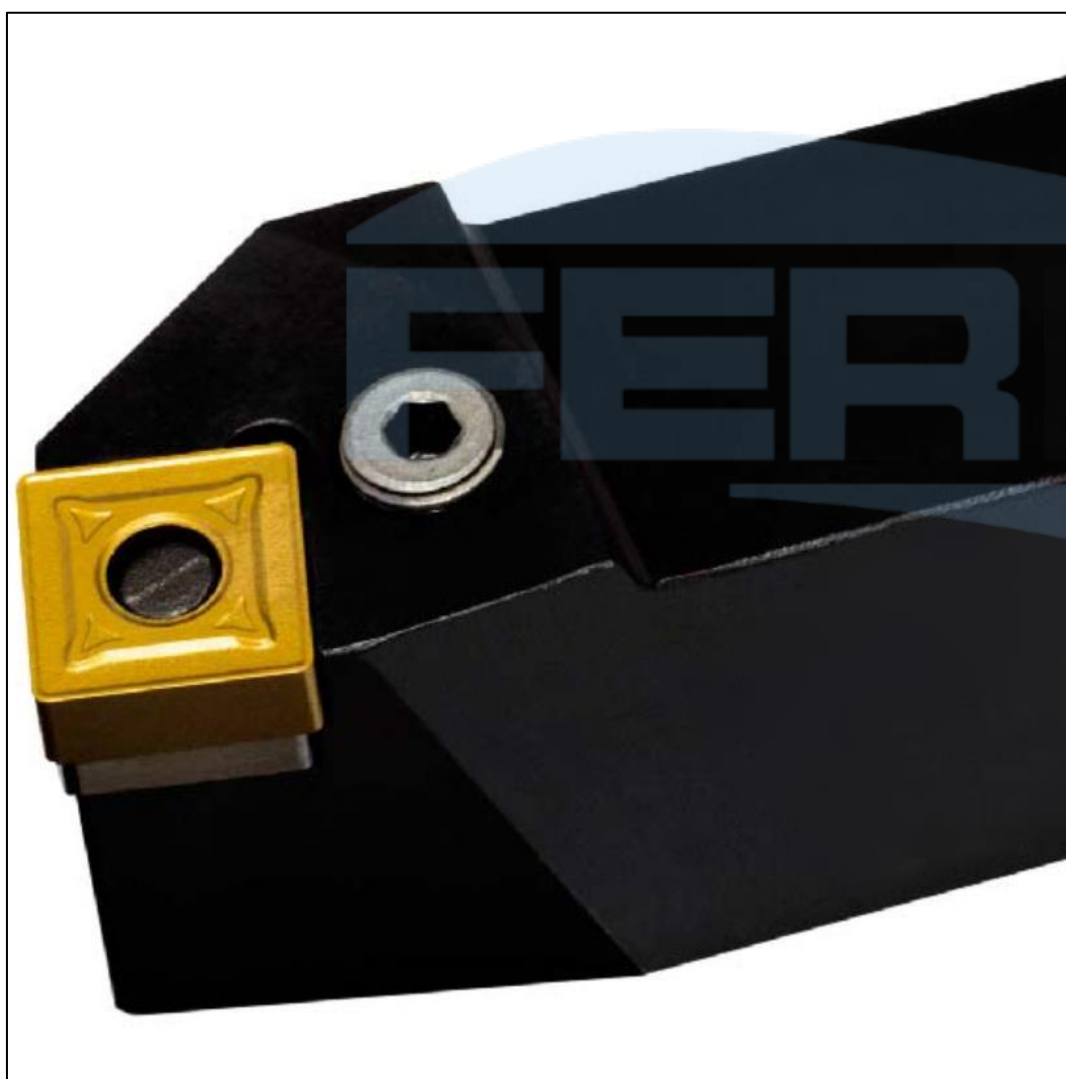
SISTEMA DE FIXAÇÃO POR ALAVANCA

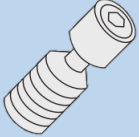
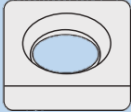
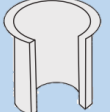
PSDNN

Suporte neutro para torneiar 45° com pastilha negativa quadrada







Ilustração na versão direita

Produtos	Dimensões (mm)				Pastilha	Acessórios				
	h	b	l	f						
PSDNN 1010 E09	10	10	70	5,3	SN_0903	174.3-845-1	174.3-829M	-	-	C - 5/64
PSDNN 1212 F09	12	12	80	6,3						
PSDNN 1616 H09	16	16	100	8,3	SN_0903	174.3-840M	174.3-820M	174.2-850	174.3-863	C - 2,5
PSDNN 2020 K09	20	20	125	10,3						
PSDNN 2020 K12	20	20	125	10,3	SN_1204	174.3-841M	174.3-821	174.2-851M	174.3-861	C - 3,0
PSDNN 2525 M12	25	25	150	12,8						
PSDNN 3232 P12	32	32	170	16,5	SN_1906	174.3-842M	174.3-822M	174.3-852M	174.3-862	C - 4,0
PSDNN 3232 P19	32	32	170	16,5						
PSDNN 4040 S19	40	40	250	21	SN_2507	174.3-844M	174.3-827	174.3-853M	174.3-865	C - 5,0
PSDNN 4040 S25	40	40	250	21						
PSDNN 5050 T25	50	50	300	26						

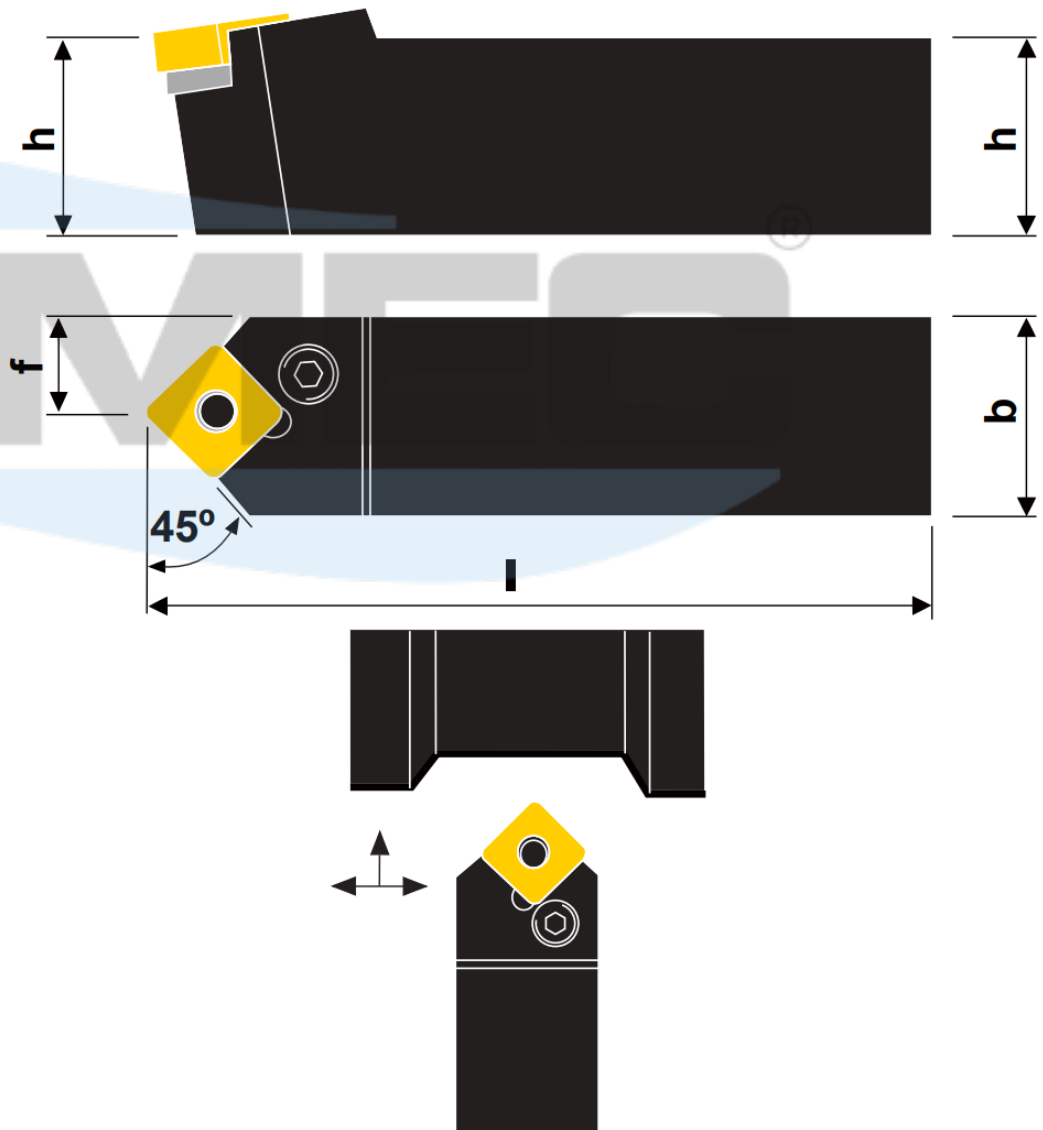
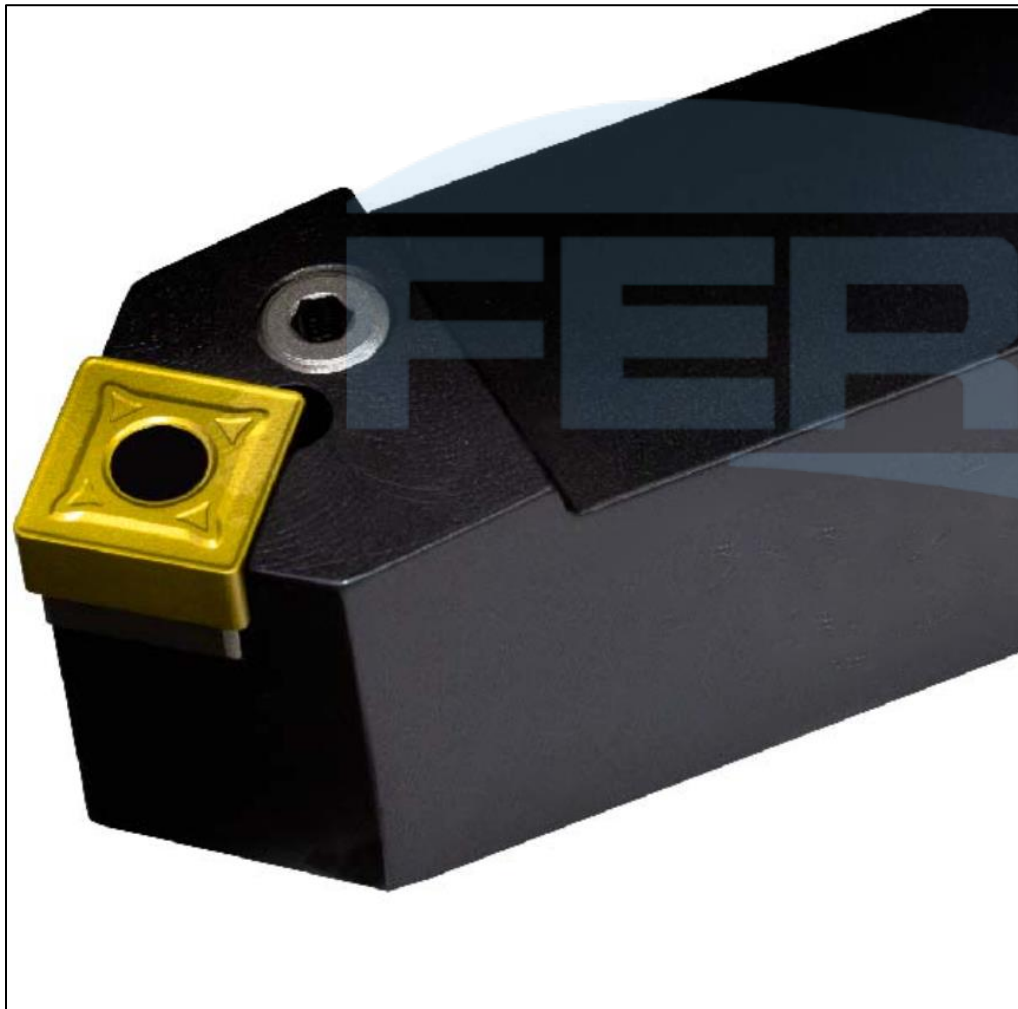
SISTEMA DE FIXAÇÃO POR ALAVANCA

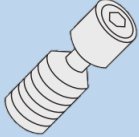
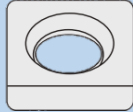
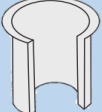
PSKNR

Suporte para facear 75° com pastilha negativa quadrada











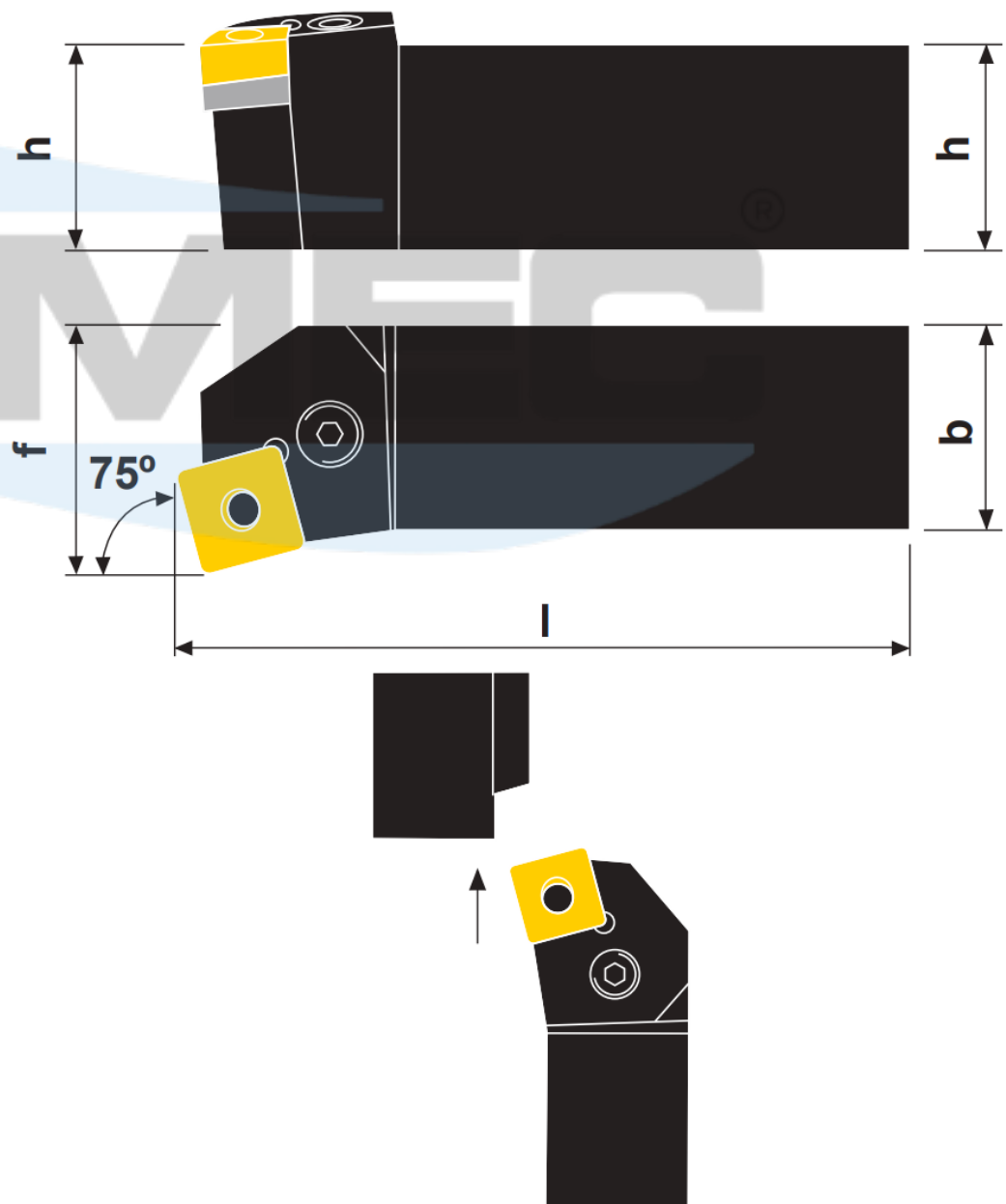

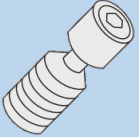
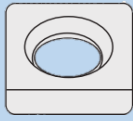
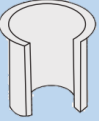

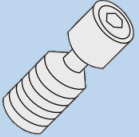
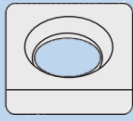
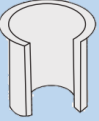
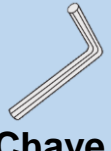
Ilustração na versão direita

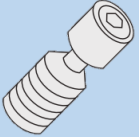
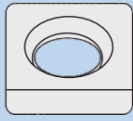
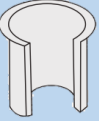
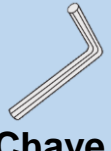
Produtos	Dimensões (mm)				Pastilha	Acessórios				
	h	b	l	f			 Alavanca	 Parafuso	 Calço	 Rebite
PSKNR/L 1616 H09	16	16	100	20	SN_0903					
PSKNR/L 2020 K09	20	20	125	25						
PSKNR/L 2020 K12	20	20	125	25	SN_1204					
PSKNR/L 2525 M12	25	25	150	32						
PSKNR/L 3225 P12	32	25	170	32	SN_1906					
PSKNR/L 3232 P19	32	32	170	40						
PSKNR/L 4040 S19	40	40	250	50	SN_2507					
PSKNR/L 4040 S25	40	40	250	50						
PSKNR/L 5050 T25	50	50	300	60						

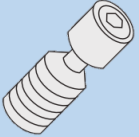
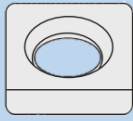
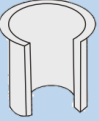
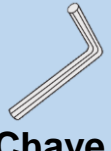
SISTEMA DE FIXAÇÃO POR ALAVANCA

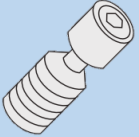
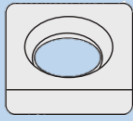
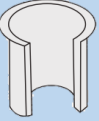
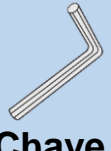
PSSNR

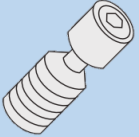
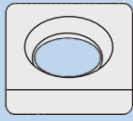
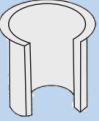
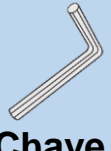
Suporte para torneiar e facear 45° com pastilha negativa quadrada











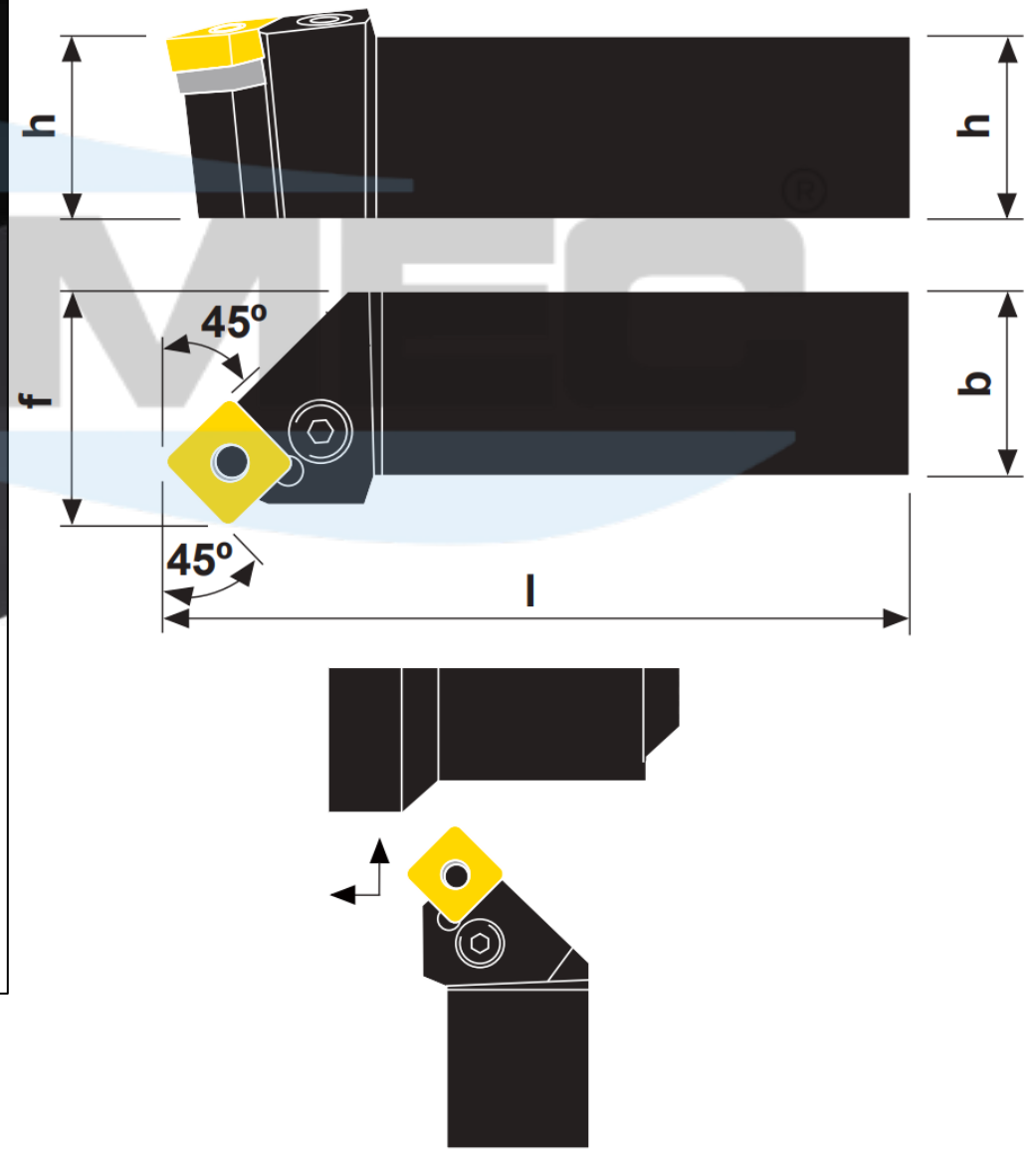
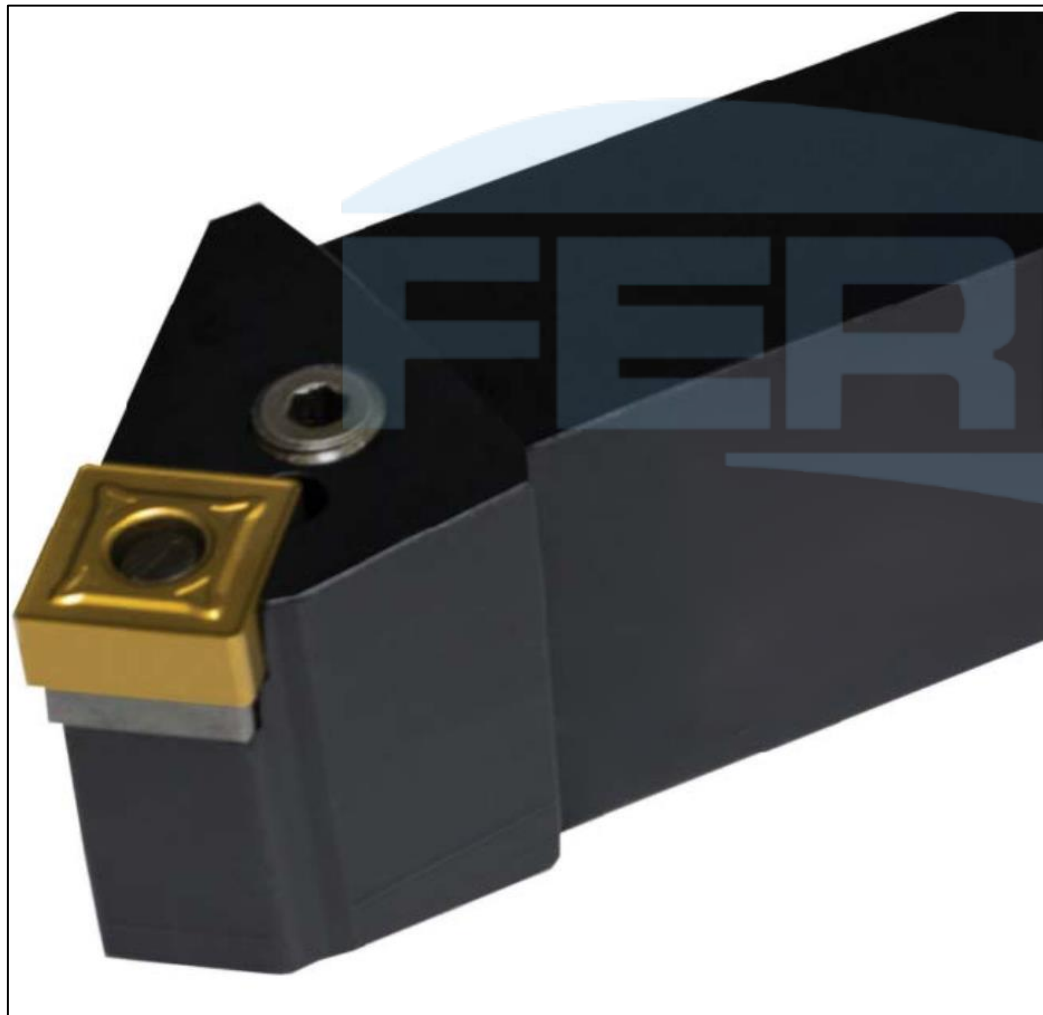

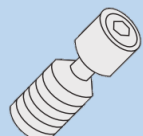
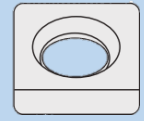
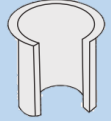
Ilustração na versão direita

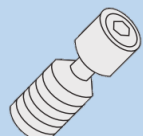
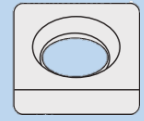
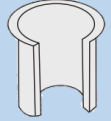
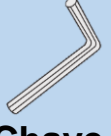
Produtos	Dimensões (mm)				Pastilha	Acessórios				
	h	b	l	f			 Alavanca	 Parafuso	 Calço	 Rebite
PSSNR/L 1616 H09	16	16	100	20	SN_0903					
PSSNR/L 2020 K09	20	20	125	25						
PSSNR/L 2020 K12	20	20	125	25	SN_1204					
PSSNR/L 2525 M12	25	25	150	32						
PSSNR/L 3225 P12	32	25	170	32						
PSSNR/L 3232 P19	32	32	170	40	SN_1906					
PSSNR/L 4040 S19	40	40	250	50						
PSSNR/L 4040 S25	40	40	250	50	SN_2507					
PSSNR/L 5050 T25	50	50	300	60						

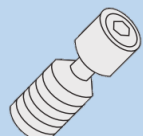
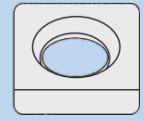
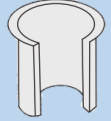
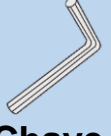
SISTEMA DE FIXAÇÃO POR ALAVANCA

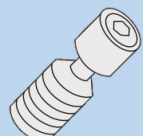
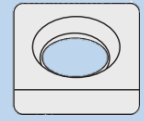
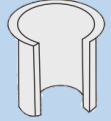
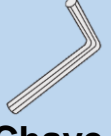
PTFNR

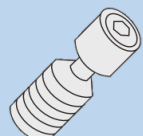
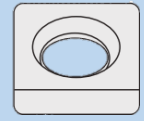
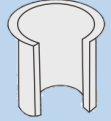
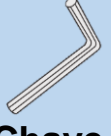
Suporte para facear 91° com pastilha negativa triangular











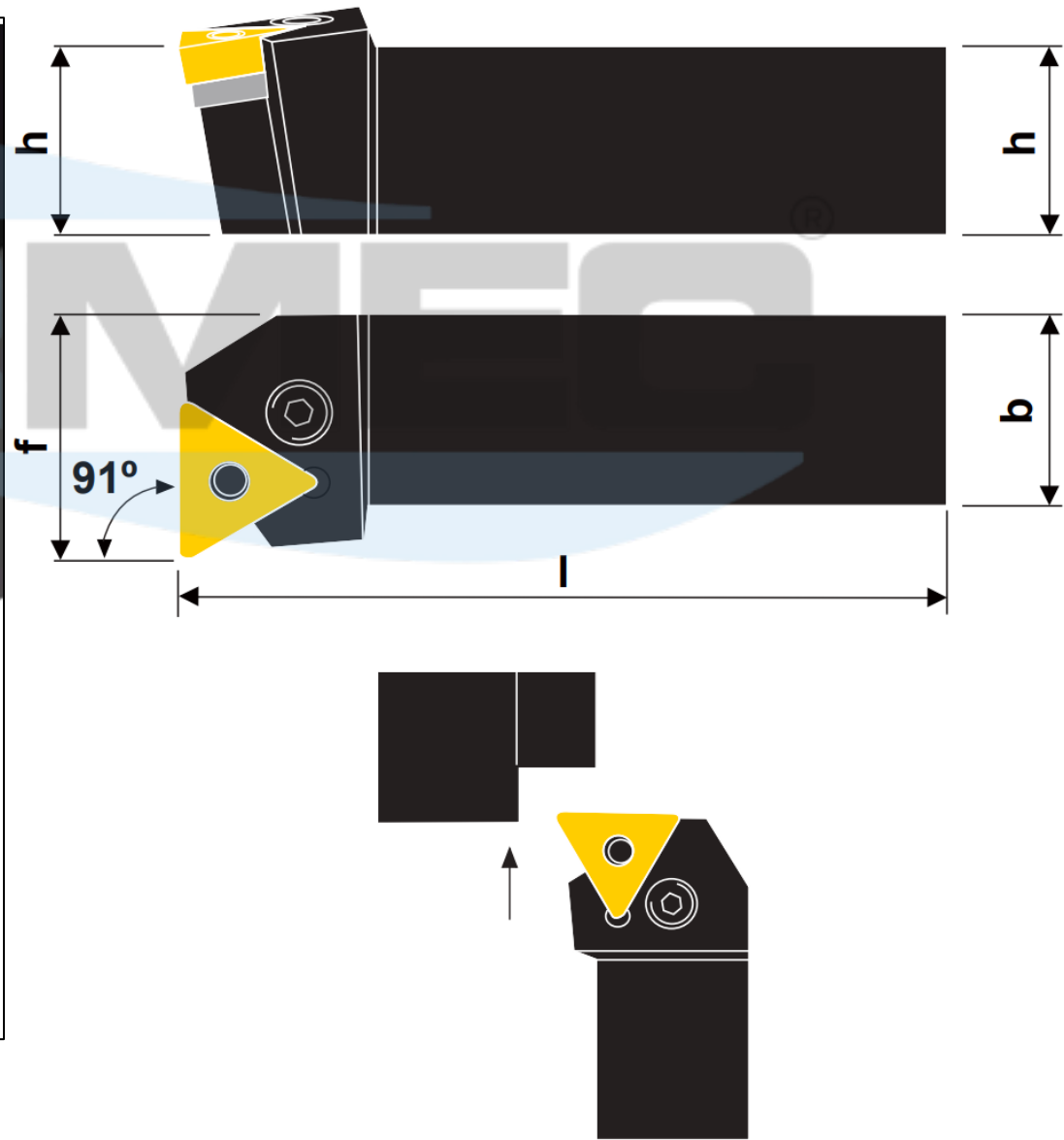
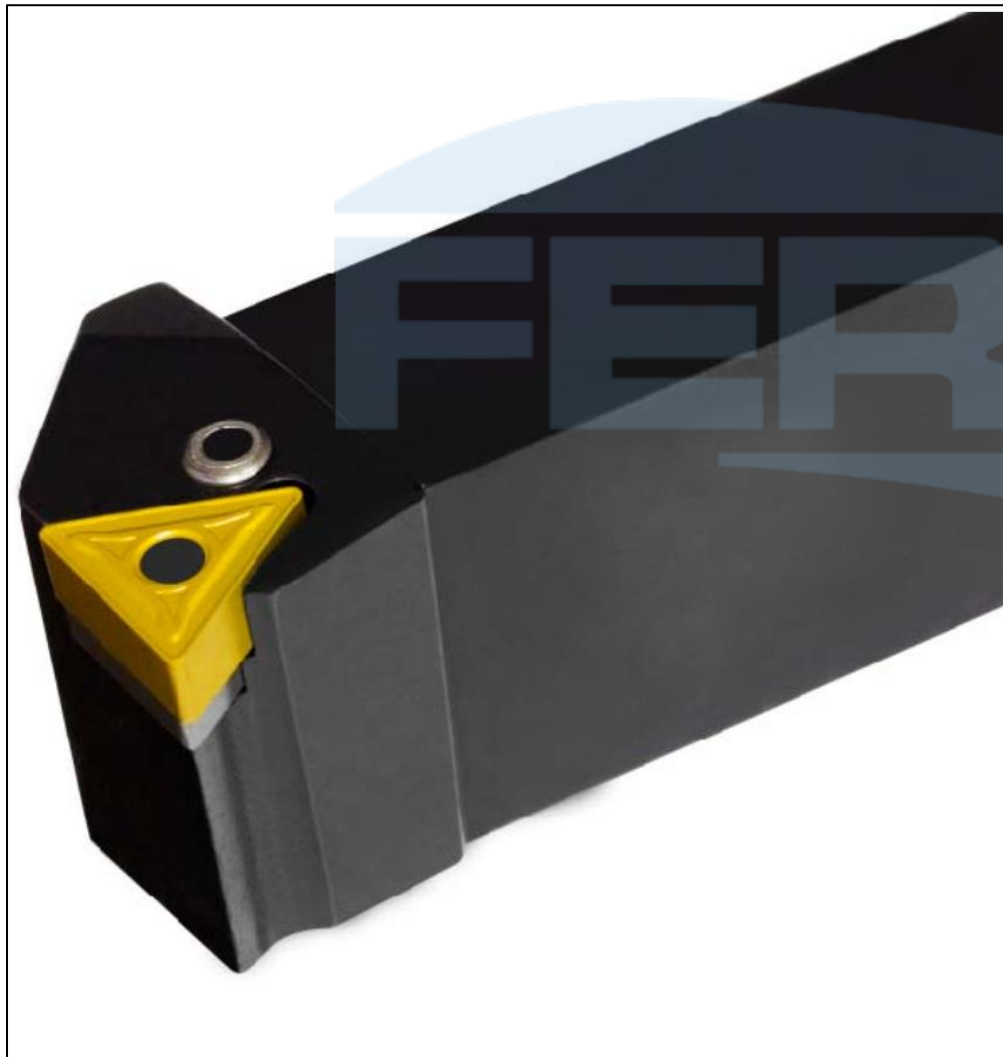
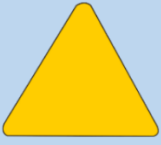

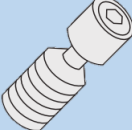
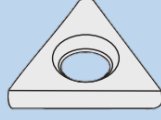
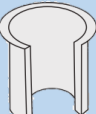
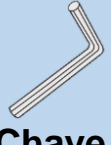
Ilustração na versão direita

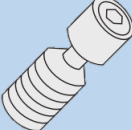
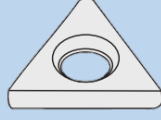
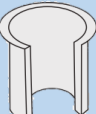
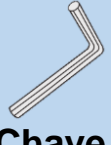
Produtos	Dimensões (mm)				Pastilha	Acessórios									
	h	b	l	f			 Alavanca	 Parafuso	 Calço	 Rebite	 Chave Allen				
PTFNR/L 1010 E11	10	10	70	15	TN_1103										
PTFNR/L 1212 F11	12	12	80	16							174.3-846-1	174.3-829	-	-	C - 5/64
PTFNR/L 1616 H16	16	16	100	20	TN_1604										
PTFNR/L 2020 K16	20	20	125	25							174.3-840M	174.3-820M	179.3-850M	174.3-860	C - 2,5
PTFNR/L 2525 M16	25	25	150	32							174.3-841M	174.3-821	179.3-852M	174.3-861	C - 3,0
PTFNR/L 3225 P16	32	25	170	32	TN_2204										
PTFNR/L 2525 M22	25	25	150	32							174.3-843M	174.3-825	179.3-854M	174.3-864	C - 3,0
PTFNR/L 3225 P22	32	25	170	32	TN_2706										
PTFNR/L 3232 P22	32	32	170	40							174.3-843M	174.3-825	179.3-854M	174.3-864	C - 3,0
PTFNR/L 4040 S27	40	40	250	50	TN_2706	174.3-843M	174.3-825	179.3-854M	174.3-864	C - 3,0					

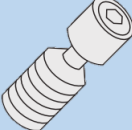
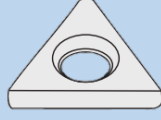
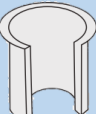
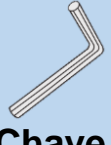
SISTEMA DE FIXAÇÃO POR ALAVANCA

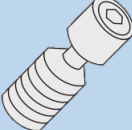
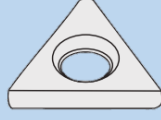
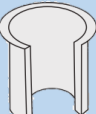
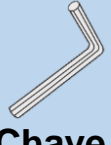
PTGNR

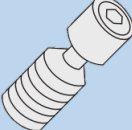
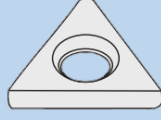
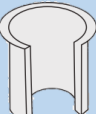
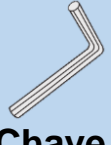
Suporte para torneiar 91° com pastilha negativa triangular





Ilustração na versão direita

Produtos	Dimensões (mm)				Pastilha	Acessórios				
	h	b	l	f		 Alavanca	 Parafuso	 Calço	 Rebite	 Chave Allen
PTGNR/L 1010 E11	10	10	70	15	TN_1103	174.3-846-1	174.3-829	-	-	C - 5/64
PTGNR/L 1212 F11	12	12	80	16						
PTGNR/L 1616 H11	16	16	100	20						
PTGNR/L 1616 H16	16	16	100	20	TN_1604	174.3-840M	174.3-820M	179.3-850M	174.3-860	C - 2,5
PTGNR/L 2020 K16	20	20	125	25						
PTGNR/L 2525 M16	25	25	150	32						
PTGNR/L 3225 P16	32	25	170	32	TN_2204	174.3-841M	174.3-821	179.3-852M	174.3-861	C - 3,0
PTGNR/L 2525 M22	25	25	150	32						
PTGNR/L 3225 P22	32	25	170	32						
PTGNR/L 3232 P22	32	32	170	40	TN_2706	174.3-843M	174.3-825	179.3-854M	174.3-864	C - 3,0
PTGNR/L 4040 S27	40	40	250	50						

SISTEMA DE FIXAÇÃO POR ALAVANCA

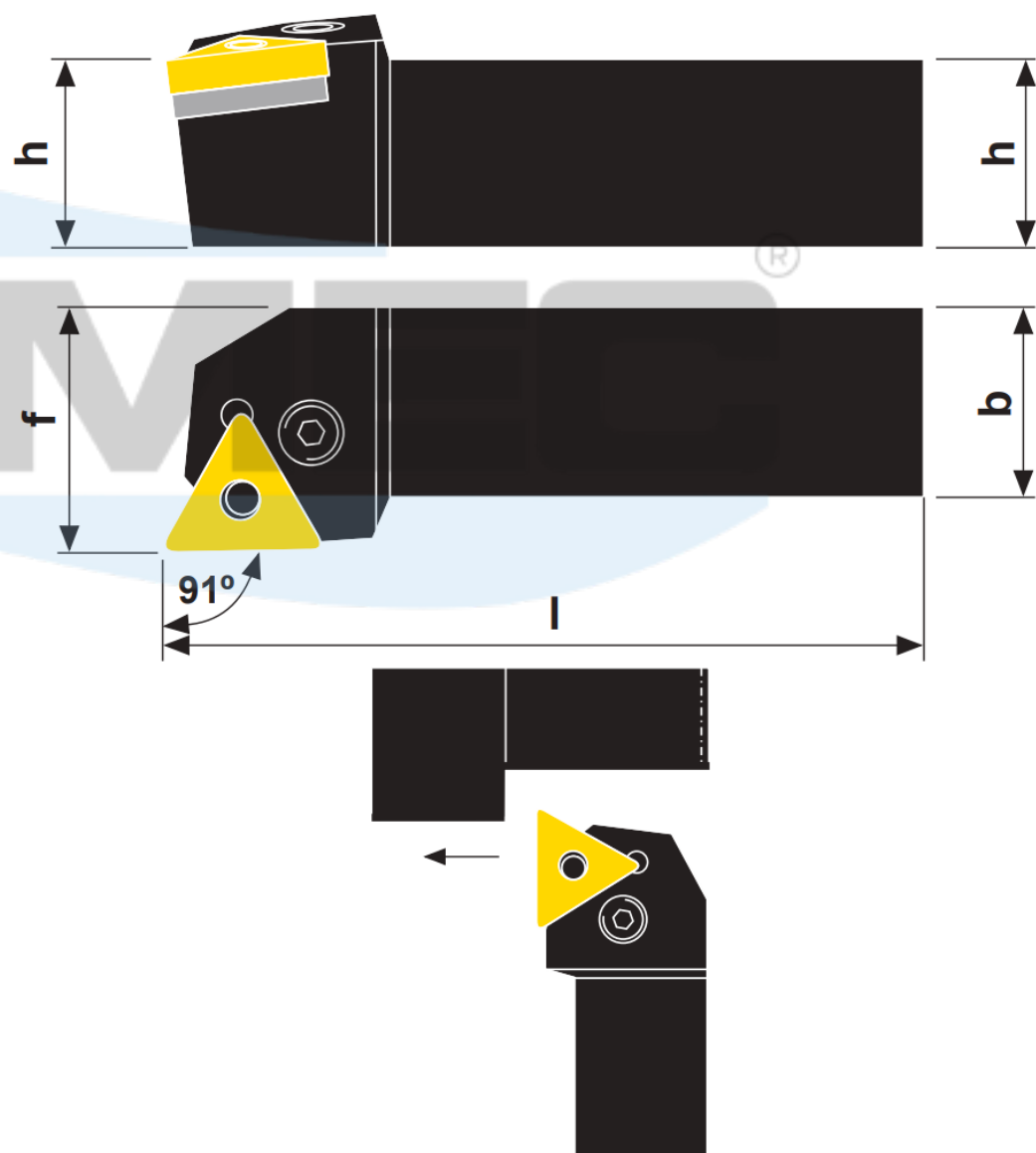
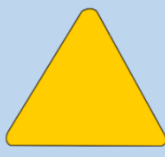
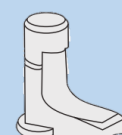
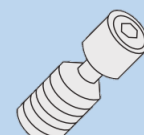
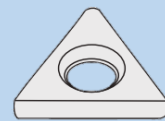
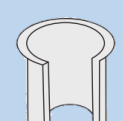
PTTNR

Suporte para torneiar 60° com pastilha negativa triangular











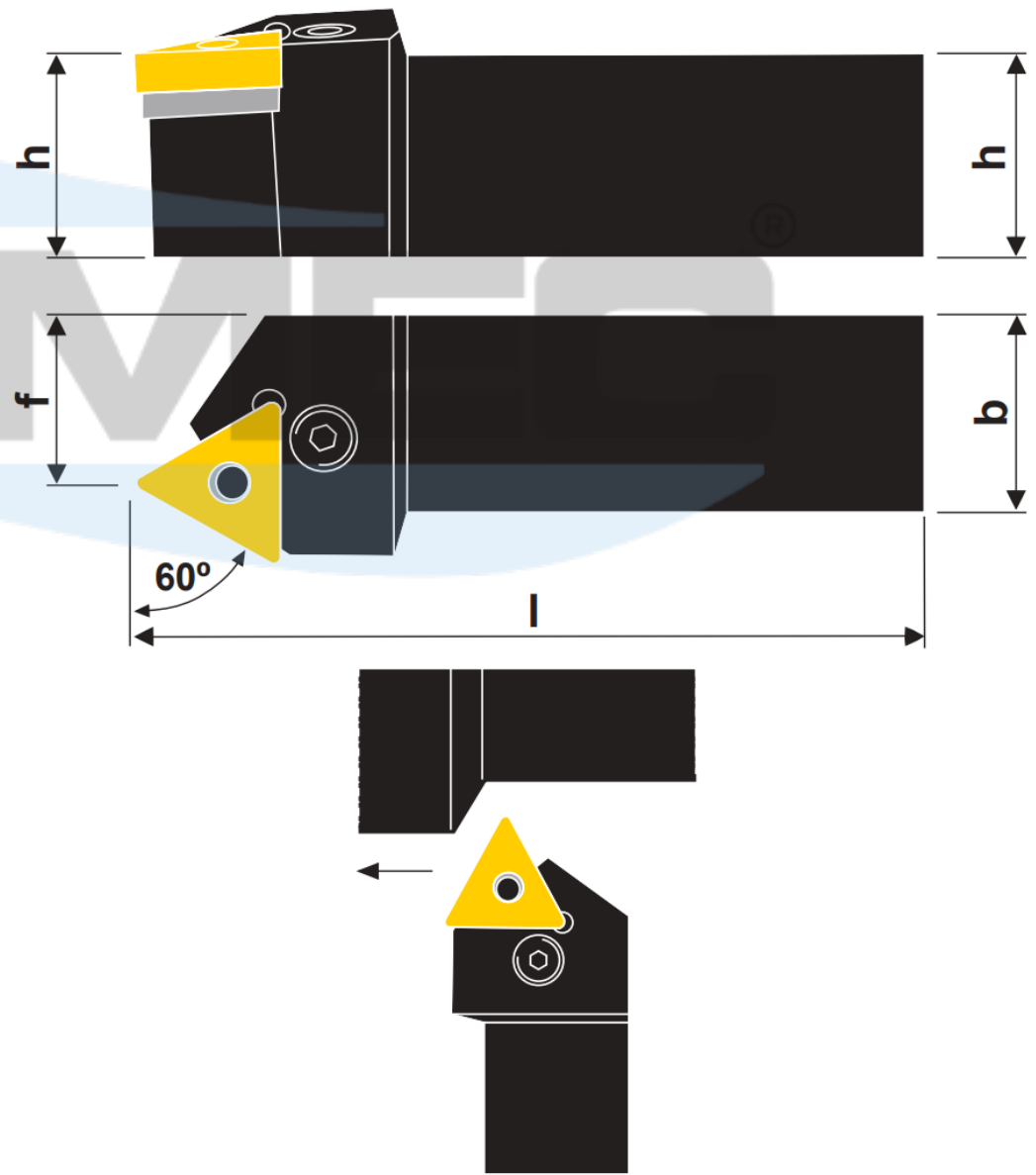

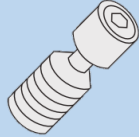
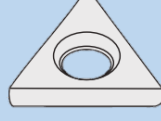
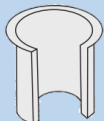
Ilustração na versão direita

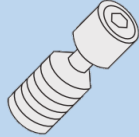
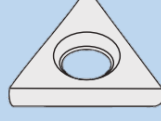
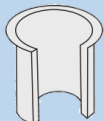
Produtos	Dimensões (mm)				Pastilha	Acessórios				
	h	b	l	f			 Alavanca	 Parafuso	 Calço	 Rebite
PTTNR/L 1212 F11	12	12	80	11	TN_1103					
PTTNR/L 1616 H11	16	16	100	13						
PTTNR/L 1616 H16	16	16	100	13	TN_1604					
PTTNR/L 2020 K16	20	20	125	17						
PTTNR/L 2525 M16	25	25	150	22						
PTTNR/L 3225 P16	32	25	170	22	TN_2204					
PTTNR/L 2525 M22	25	25	150	22						
PTTNR/L 3225 P22	32	25	170	22						

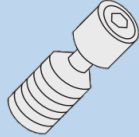
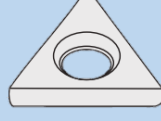
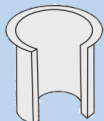
SISTEMA DE FIXAÇÃO POR ALAVANCA

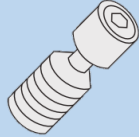
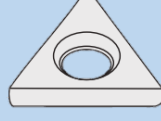
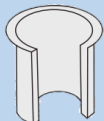
PVACR

Suporte para torneiar 91° com pastilha negativa triangular



Ilustração na versão direita

Produtos	Dimensões (mm)				Pastilha	Acessórios			
	h	b	l	f		Alavanca	Parafuso da Alavanca	Pino	Chave Allen
PVACR/L 0808M-11S	8	8	150	8	VC_1103	SL LV-2	SR 10400611	SL PI-2	C - 2,0
PVACR/L 1010M-11S	10	10	150	10,2					
PVACR/L 1212M-11S	12	12	150	12,2					
PVACR/L 1616M-11S	16	16	150	16,2					
PVACR/L 1012M-16S	10	10	150	10	VC_1604	SL LV-3	SR 10400150	SL PI-3	C - 2,5
PVACR/L 1212M-16S	12	12	150	12					
PVACR/L 1616M-16S	16	16	150	16					

SISTEMA DE FIXAÇÃO DUPLO POR PINO E GRAMPO

MCBNR

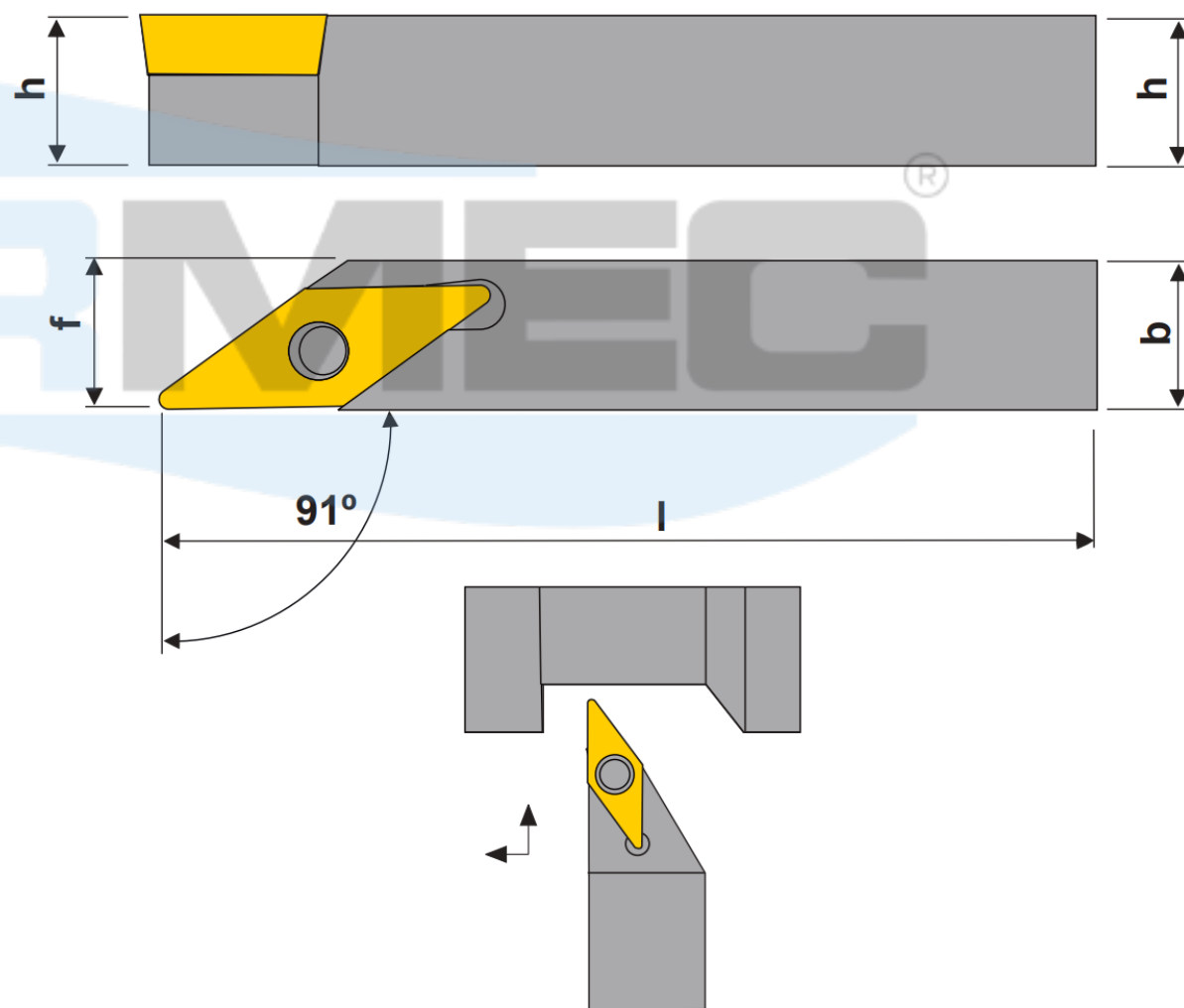
Suporte para torneiar 75° com pastilha negativa 80° para aproveitamento do ângulo de 100°







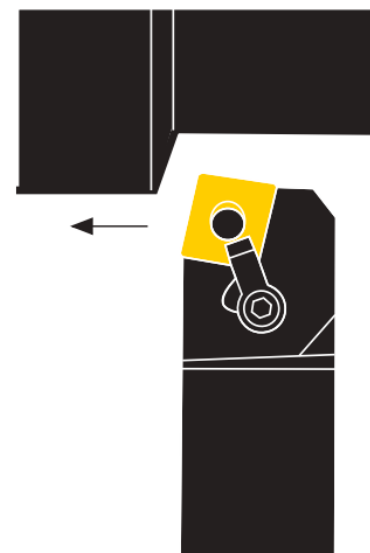
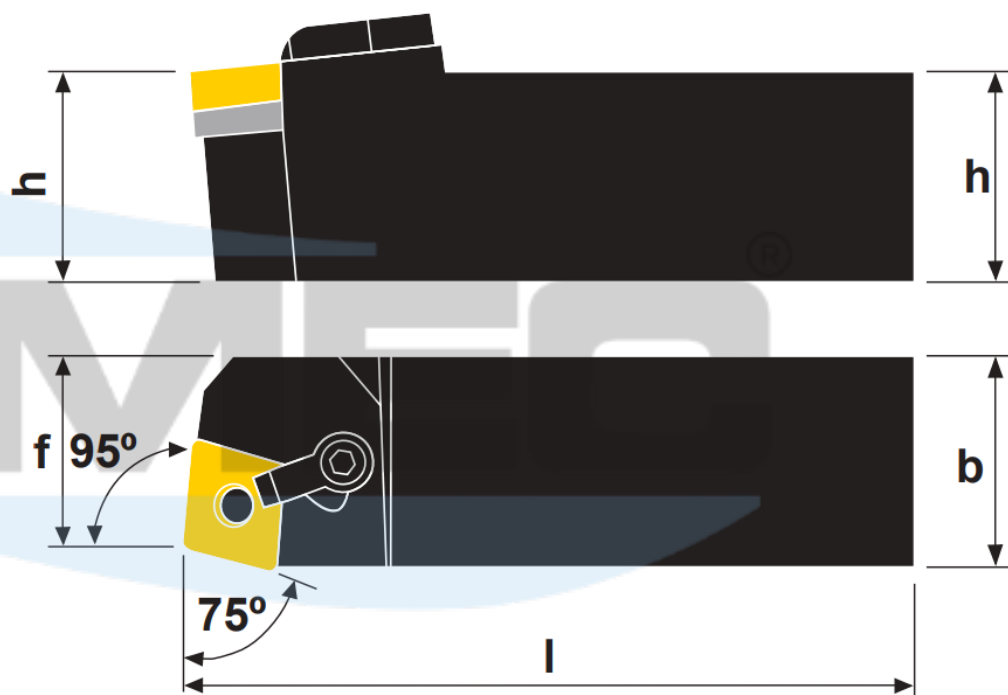

Ilustração na versão direita

Produtos	Dimensões (mm)				Pastilha	Acessórios				
	h	b	l	f			 Grampo	 Parafuso	 Calço	 Pino Paraf. do Calço
MCBNR/L 2020 K12	20	20	125	17	CN_1204 CNGN_1204 CNGN_1203	 HL1813	 MC1204	 CTM617	 ML0625	M - 2,5 M - 3,0
MCBNR/L 2525 M12	25	25	150	22						
MCBNR/L 3225 P12	32	25	170	22						
MCBNR/L 2525 M16	25	25	150	22	CN_1606 CNGN1606	NC-9 NC-12	HT-2	SCN-53	NL-58 PS-58	C - 1/8 C - 4,0
MCBNR/L 3225 P16	32	25	170	27						
MCBNR/L 3232 P19	32	32	170	27	CN_1906 CNGN1906	HL2217	MC1904	CTM1022	ML0830	M - 4,0
MCBNR/L 4040 S19	40	40	250	35						

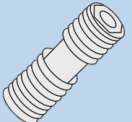
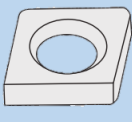
SISTEMA DE FIXAÇÃO DUPLO POR PINO E GRAMPO

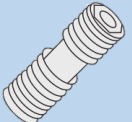
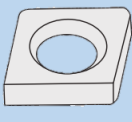
MCKNR

Suporte para facear 75° com pastilha negativa 80° para aproveitamento do ângulo de 100°







Ilustração na versão direita

Produtos	Dimensões (mm)				Pastilha	Acessórios				
	h	b	l	f			 Grampo	 Parafuso	 Calço	 Pino Paraf. do Calço
MCKNR/L 2020 K12	20	20	125	17	CN_1204 CNGN_1204 CNGN_1203	 HL1813	 MC1204	 CTM617	 ML0625	M - 2,5 M - 3,0
MCKNR/L 2525 M12	25	25	150	22						
MCKNR/L 3225 P12	32	25	170	22						
MCKNR/L 2525 M16	25	25	150	22	CN_1606 CNGN1606	NC-9 NC-12	HT-2	SCN-53	NL-58 PS-58	C - 1/8 C - 4,0
MCKNR/L 3225 P16	32	25	170	27						
MCKNR/L 3232 P19	32	32	170	27	CN_1906 CNGN1906	HL2217	MC1904	CTM1022	ML0830	M - 4,0
MCKNR/L 4040 S19	40	40	250	35						

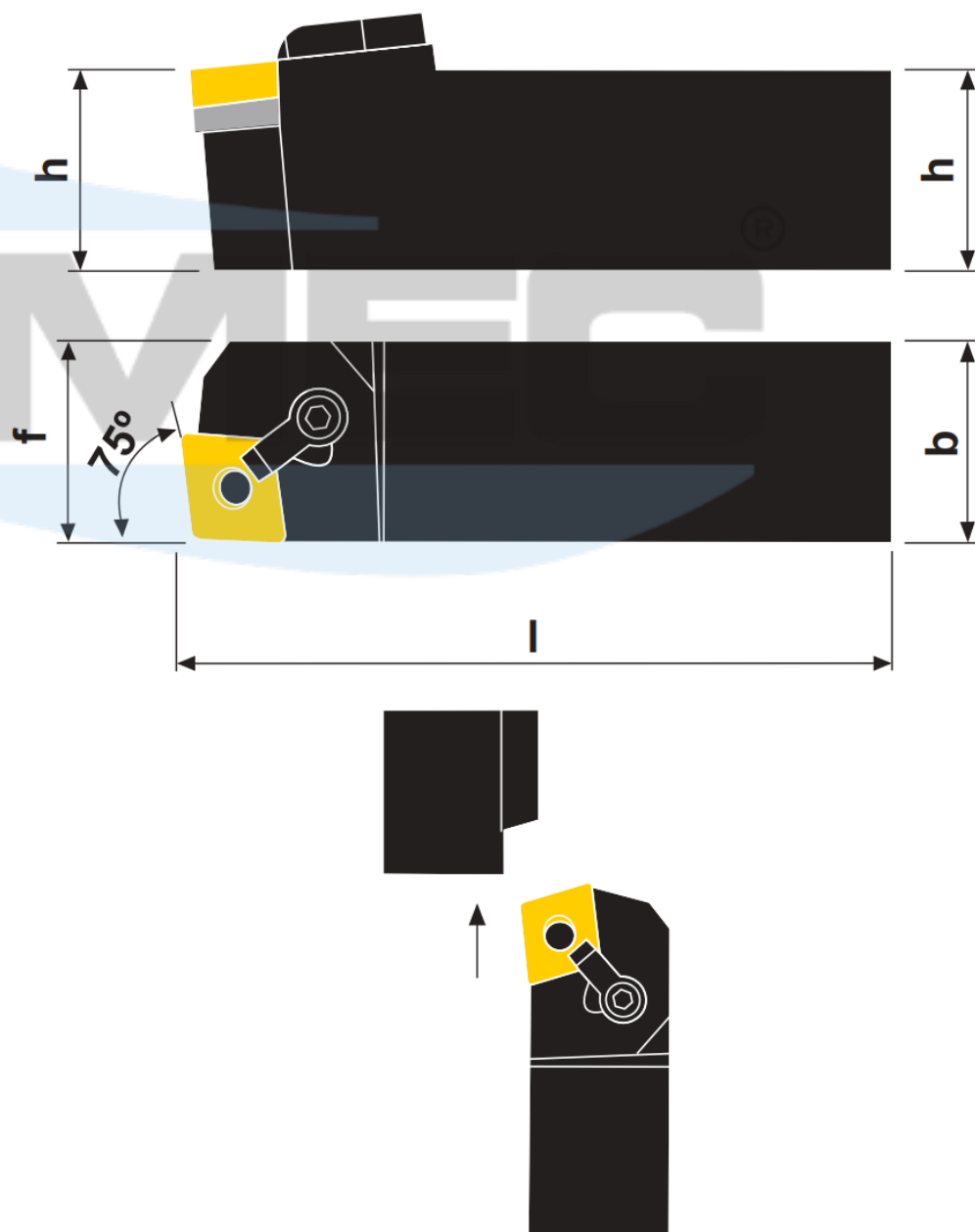
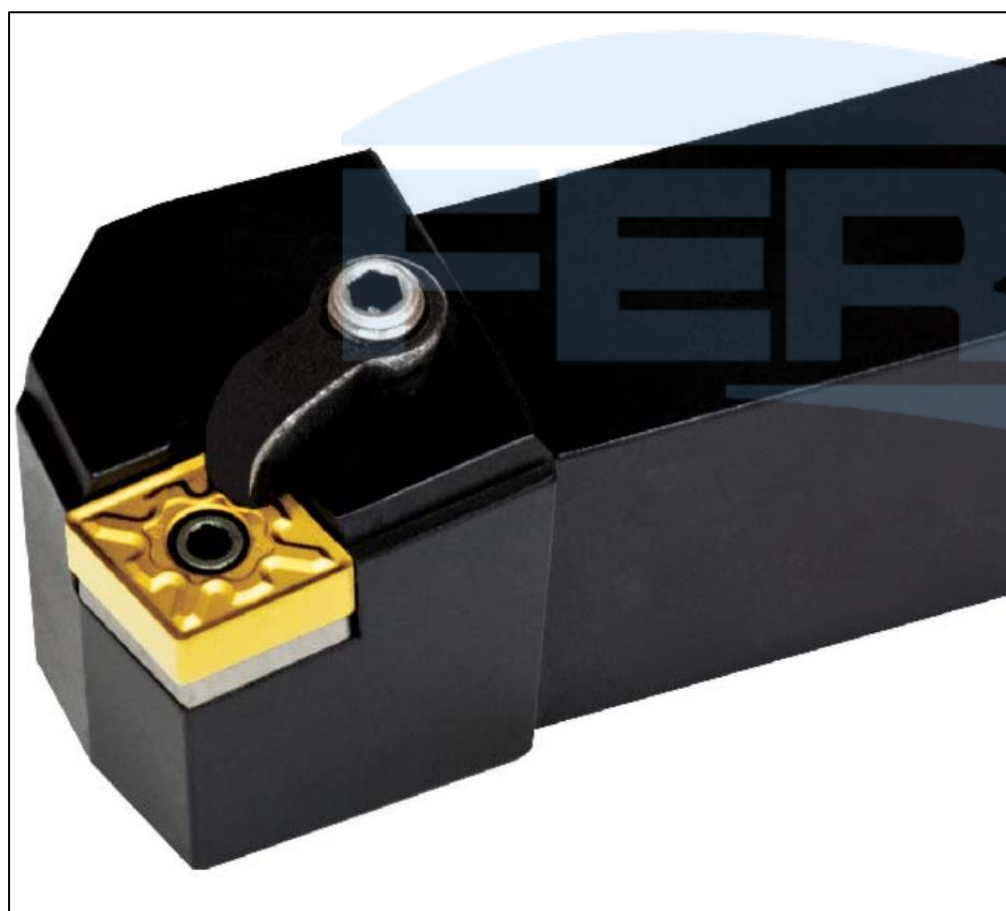
SISTEMA DE FIXAÇÃO DUPLO POR PINO E GRAMPO

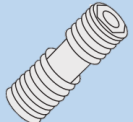
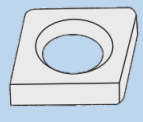
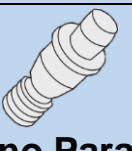
MCLNR

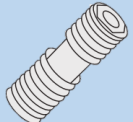
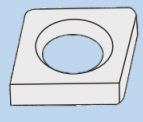
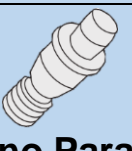
Suporte para torneiar e facear 95° com pastilha negativa 80°





Ilustração na versão direita

Produtos	Dimensões (mm)				Pastilha 	Acessórios				
	h	b	l	f		Grampo	Parafuso	Calço	Pino Paraf. do Calço	Chave Allen
MCLNR/L 2020 K12	20	20	125	25	CN_1204 CNGN_1204 CNGN_1203	HL1813	MC1204	CTM617	ML0625	M - 2,5 M - 3,0
MCLNR/L 2525 M12	25	25	150	32						
MCLNR/L 3225 P12	32	25	170	32						
MCLNR/L 2525 M16	25	25	150	32	CN_1606 CNGN1606	NC-9 NC-12	HT-2	SCN-53	NL-58 PS-58	C - 1/8 C - 4,0
MCLNR/L 3225 P16	32	32	170	32						
MCLNR/L 3232 P19	32	32	170	40	CN_1906 CNGN1906	HL2217	MC1904	CTM1022	ML0830	C - 4,0
MCLNR/L 4040 S19	40	40	250	50						

SISTEMA DE FIXAÇÃO DUPLO POR PINO E GRAMPO

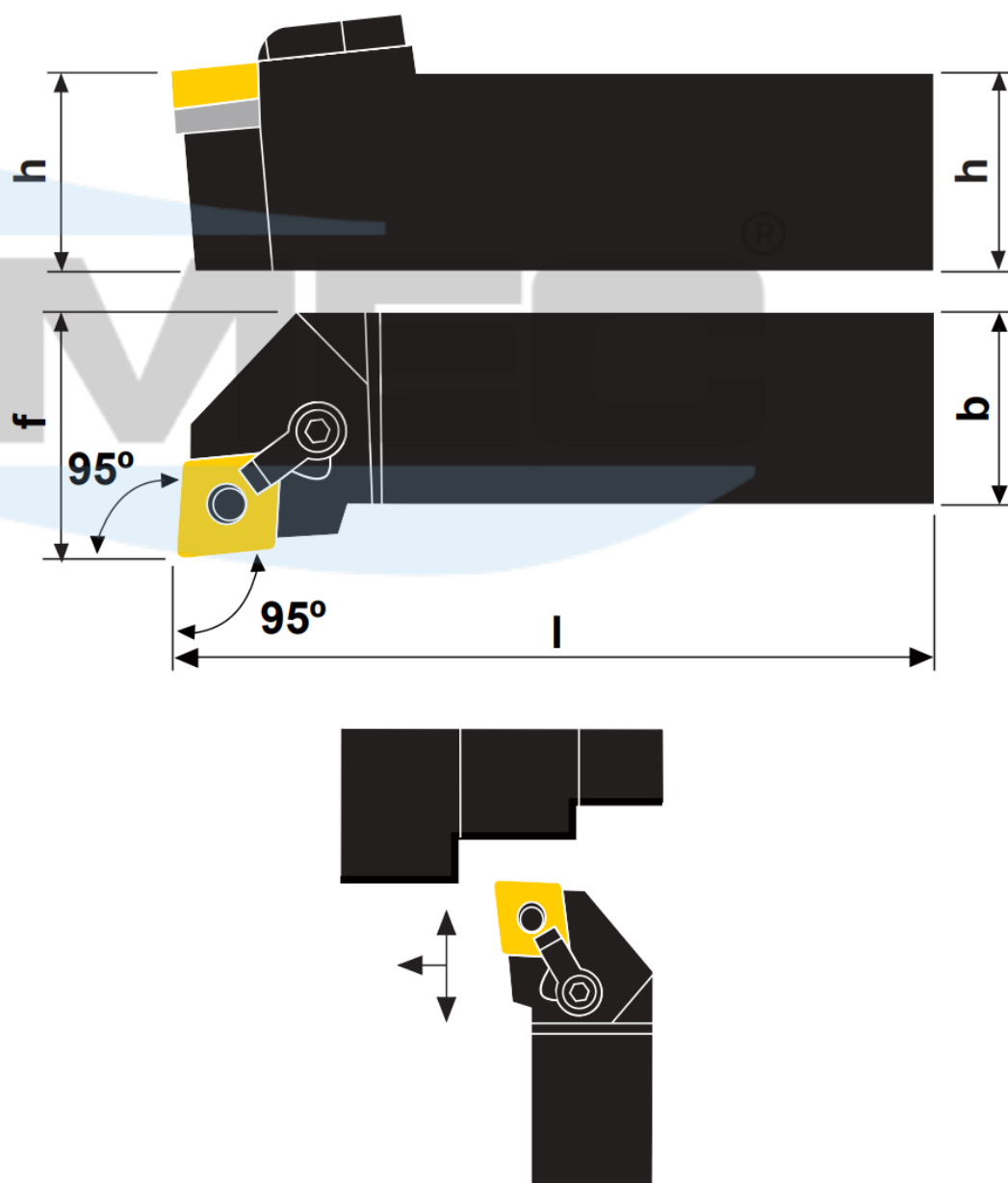
MCDNN

Suporte neutro 40° com pastilha negativa 80° para aproveitamento do ângulo de 100°





Ilustração na versão direita

Produtos	Dimensões (mm)				Pastilha	Acessórios				
	h	b	l	f		Grampo	Parafuso	Calço	Pino Paraf. do Calço	Chave Allen
MCDNN 2020 K12	20	20	125	10,3	 CN_1204 CNGN 1204 CNGN 1203	 NC-20 NC-23	 HT-1	 SCN-43 ICSN-433	 H308-1C H308-1CH	 C - 2,5 C - 1/8
MCDNN 2525 M12	25	25	150	12,8						
MCDNN 3225 P12	32	25	170	16,8						
MCDNN 4040 S19	40	40	250	21	CN_1906 CNGN1906	NC-9 NC-30	HT-2	SCN-64C	H312-1C H312-1CH	C - 4,0
MCDNN 5050 T19	50	50	300	26						

SISTEMA DE FIXAÇÃO DUPLO POR PINO E GRAMPO

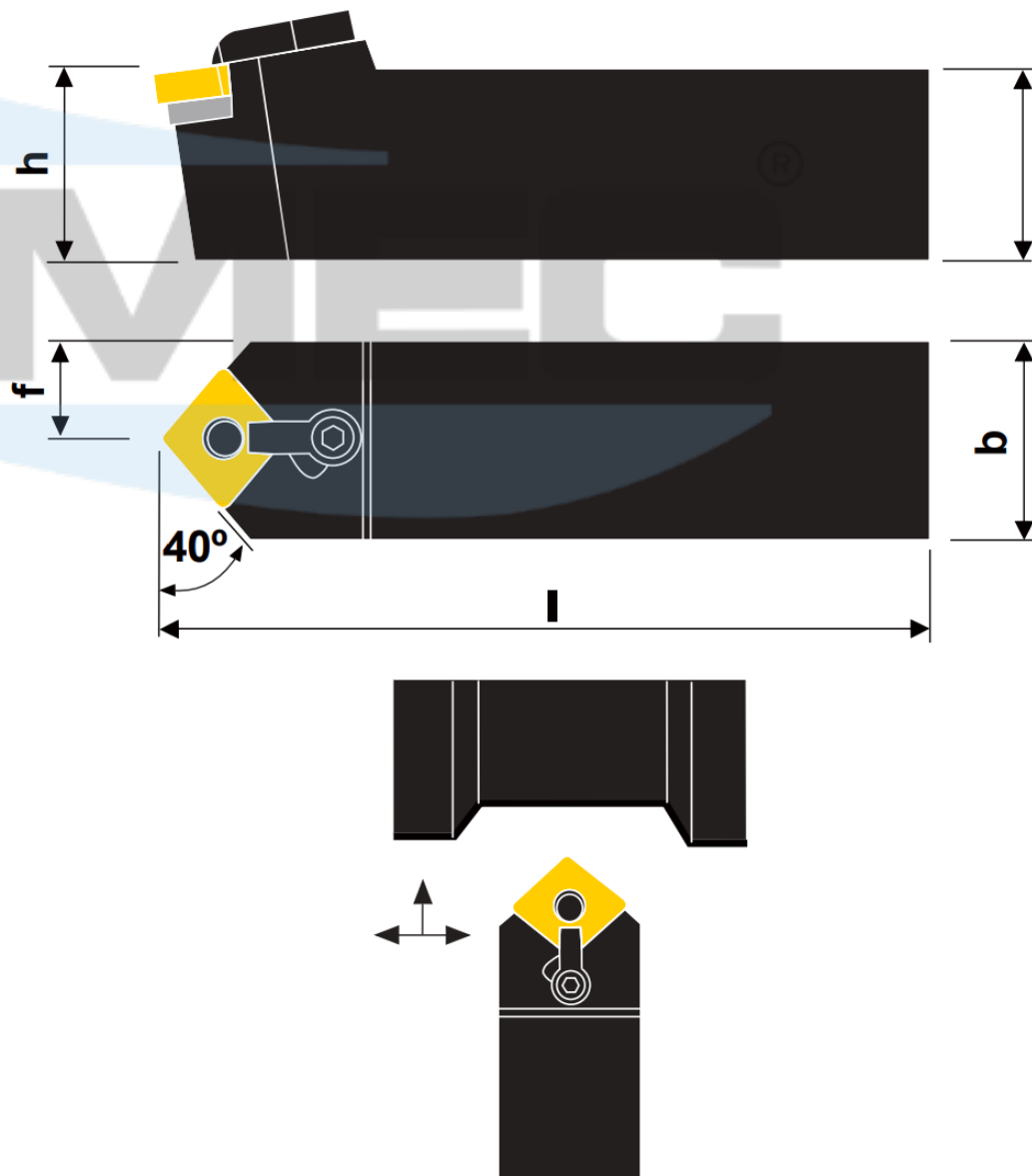
MDJNR

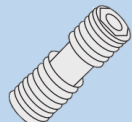
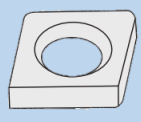
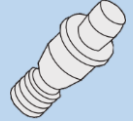
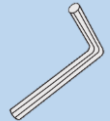
Suporte para tornear 93° com pastilha negativa 55°







Ilustração na versão direita

Produtos	Dimensões (mm)				Pastilha 	Acessórios				
	h	b	l	f						
MDJNR/L 2020 K15	20	20	125	25	DN_1506 DNGN 1506	HL2114	ML0625	MD1504	CTM619	M - 2.5 M - 3.0
MDJNR/L 2525 M15	25	25	150	32						
MDJNR/L 3225 P15	32	25	170	32						
MDJNR/L 4025 R15	40	25	200	32						

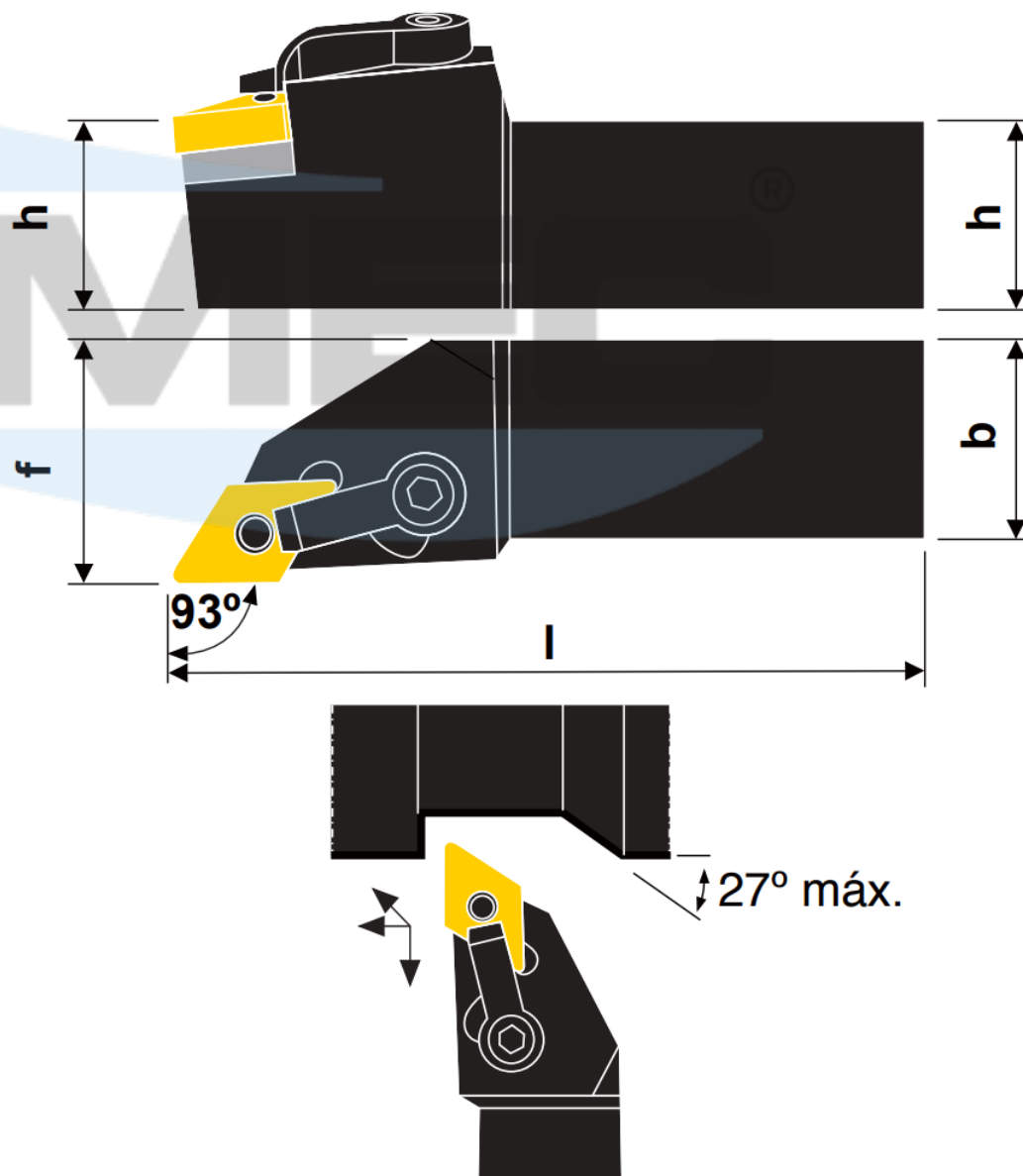
SISTEMA DE FIXAÇÃO DUPLO POR PINO E GRAMPO

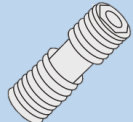
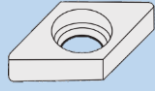
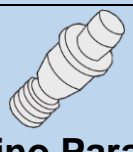
MDNNN

Suporte neutro para torneiar e facear 62°30' com pastilha negativa 55°





Ilustração na versão direita

Produtos	Dimensões (mm)				Pastilha	Acessórios				
	h	b	l	f		Grampo	Parafuso	Calço	Pino Paraf. do Calço	Chave Allen
MDNNN 2020 K15	20	20	125	10	 DN_1506 DNGN 1506	 NC-9 NC-22	 HT-2	DSN-422	 NL-46 PS-46	 C - 3/32 C - 4
MDNNN 2525 M15	25	25	150	12,5						
MDNNN 3225 P15	32	25	170	12,5						
MDNNN 4025 R15	40	25	200	12,5						

SISTEMA DE FIXAÇÃO DUPLO POR PINO E GRAMPO

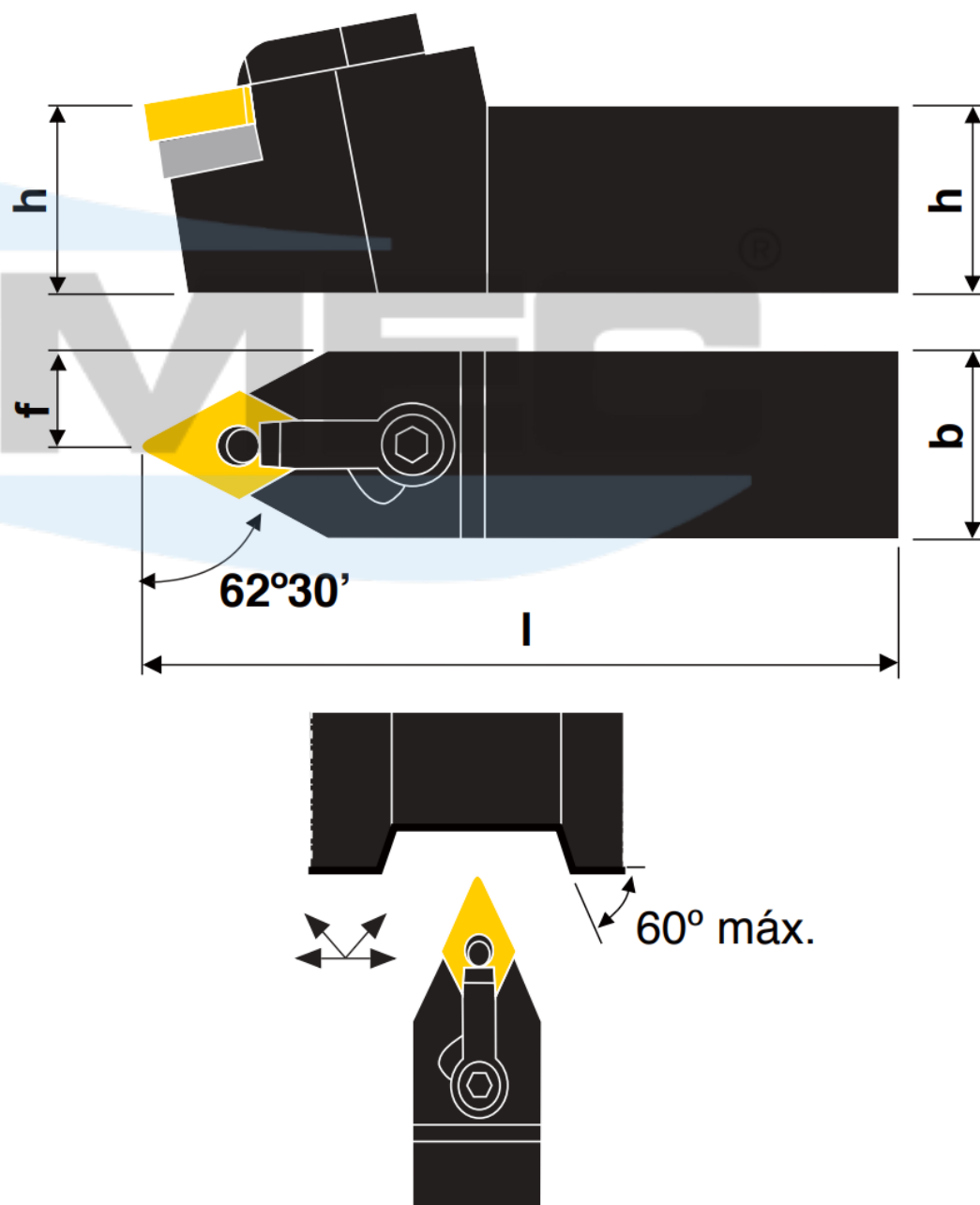
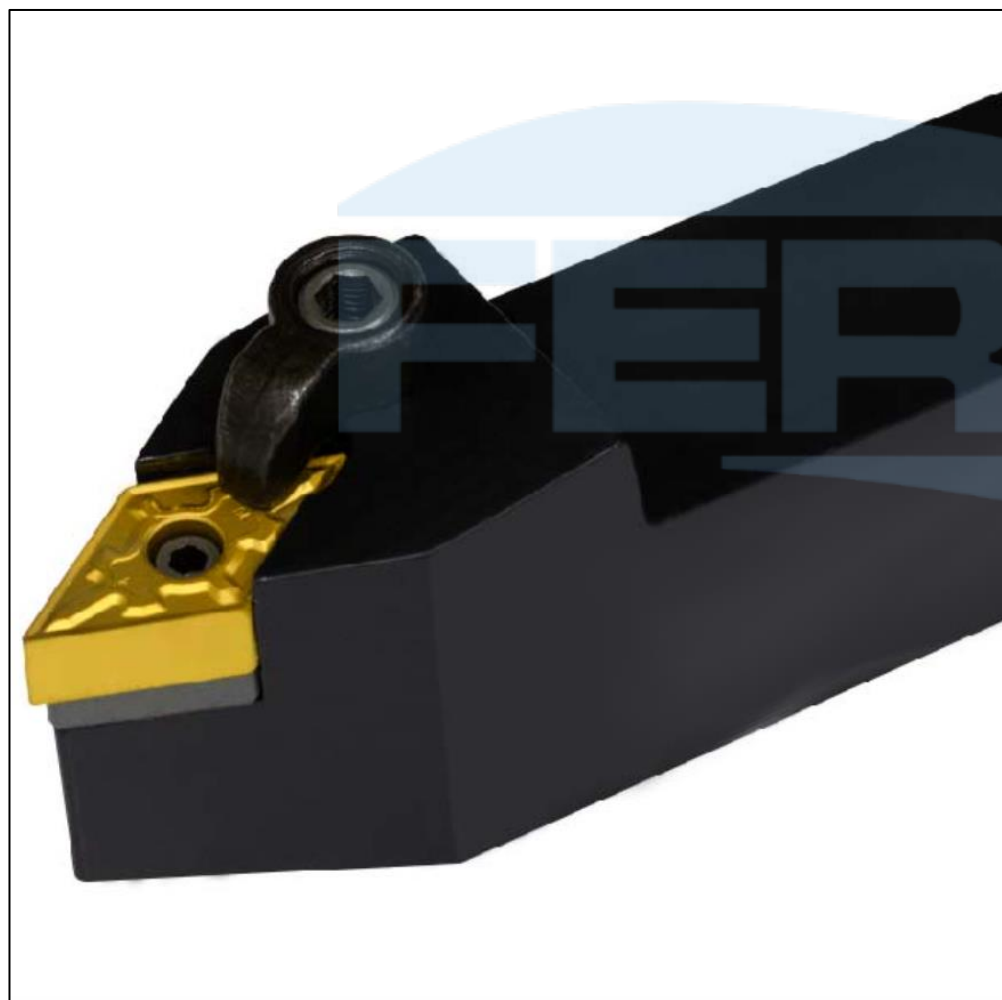
MRDNN

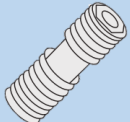
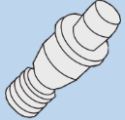
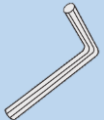
Suporte neutro para torneiar e facear com pastilha negativa redonda







Ilustração na versão direita

Produtos	Dimensões (mm)				Pastilha	Acessórios				
	h	b	l	f			 Grampo	 Parafuso	 Calço	 Pino Paraf. do Calço
MRDNN 2020 K09	20	20	125	14,8	RN_0903 RNGN 0903	NC-20 NC-23	HT-1	IRSN-32	NL-34 PS-34	C - 2,0 C - 3,0
MRDNN 2525 M09	25	25	150	17,3						
MRDNN 3225 P09	32	25	170	17,3						
MRDNN 2020 K12	20	20	125	16,3	RN_1204 RNGN 1204	NC-20 NC-23	HT-1	IRSN-42	NL-46 PS-46	C - 1/8 C - 3/32
MRDNN 2525 M12	25	25	150	18,8						
MRDNN 3225 P12	32	25	170	18,8						
MRDNN 3232 P15	32	32	170	23,8	RN_1506 RNGN 1506	NC-9 NC-12	HT-2	IRSN-53	NL-58 PS-58	C - 1/8 C - 4,0
MRDNN 4040 S15	40	40	250	27,8						

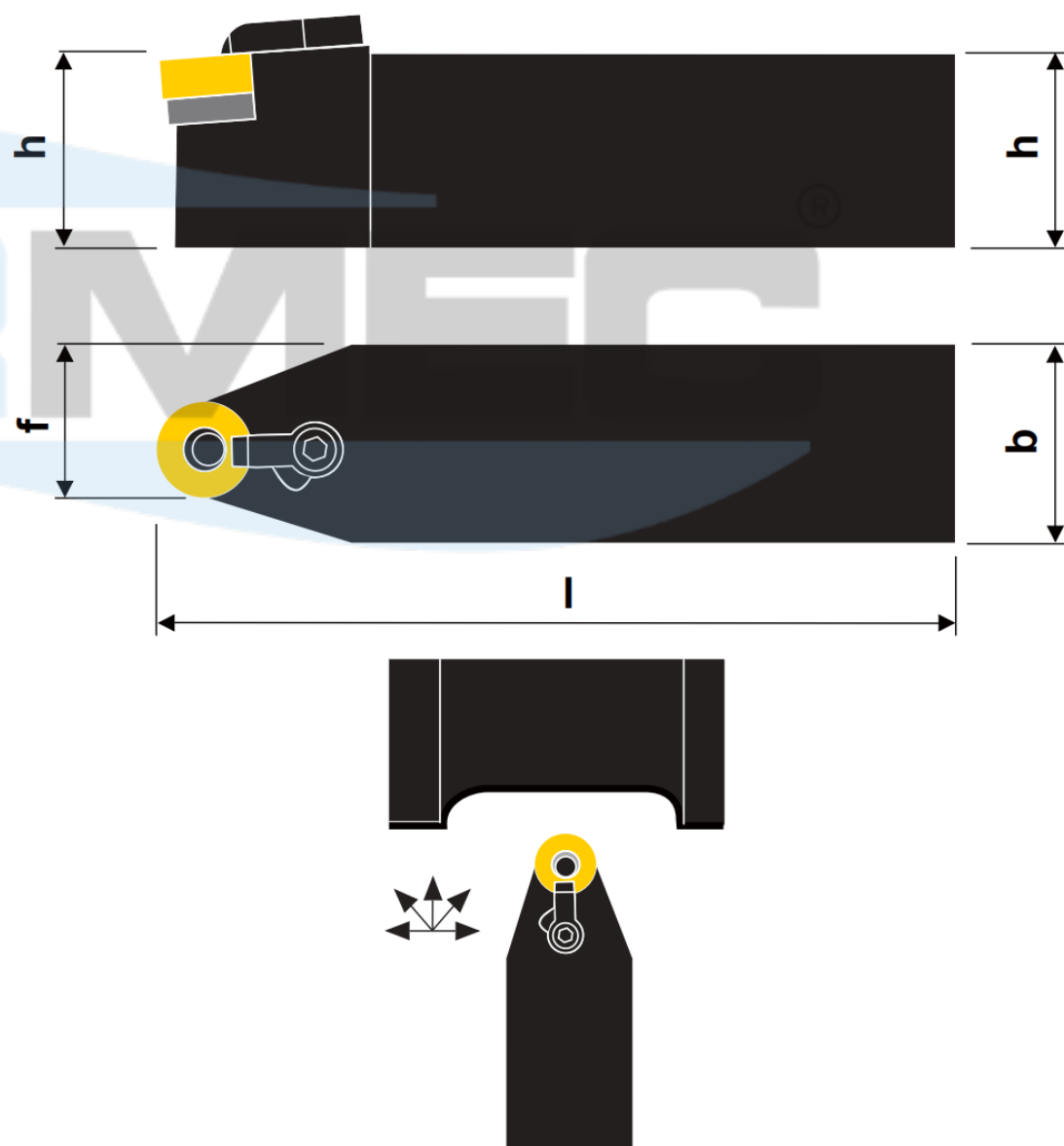
SISTEMA DE FIXAÇÃO DUPLO POR PINO E GRAMPO

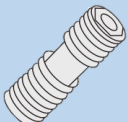
MSBNR

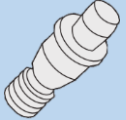
Suporte para torneiar 75° com pastilha negativa quadrada





Ilustração na versão direita

Produtos	Dimensões (mm)				Pastilha	Acessórios				
	h	b	l	f			 Grampo	 Parafuso	 Calço	 Pino Paraf. do Calço
MSBNR/L 2020 K12	20	20	125	17	SN_1204 SNGN 1204	NC-20 NC-23	HT-1	ISSN-423	NL-46 PS-46	C - 3/32 C - 1/8
MSBNR/L 2525 M12	25	25	150	22						
MSBNR/L 3225 P12	32	25	170	22						
MSBNR/L 3232 P12	32	32	170	27	SN_1506 SNGN 1506	NC-9 NC-12	HT-2	ISSN-543	NL-58 PS-58	C - 1/8 C - 4
MSBNR/L 4040 S15	40	40	250	35						
MSBNR/L 3232 P19	32	32	170	27	SN_1906 SNGN 1906	NC-9 NC-30	HT-2	SSN-64C	H312-1C H312-1CH	C - 4
MSBNR/L 4040 S19	40	40	250	35						

SISTEMA DE FIXAÇÃO DUPLO POR PINO E GRAMPO

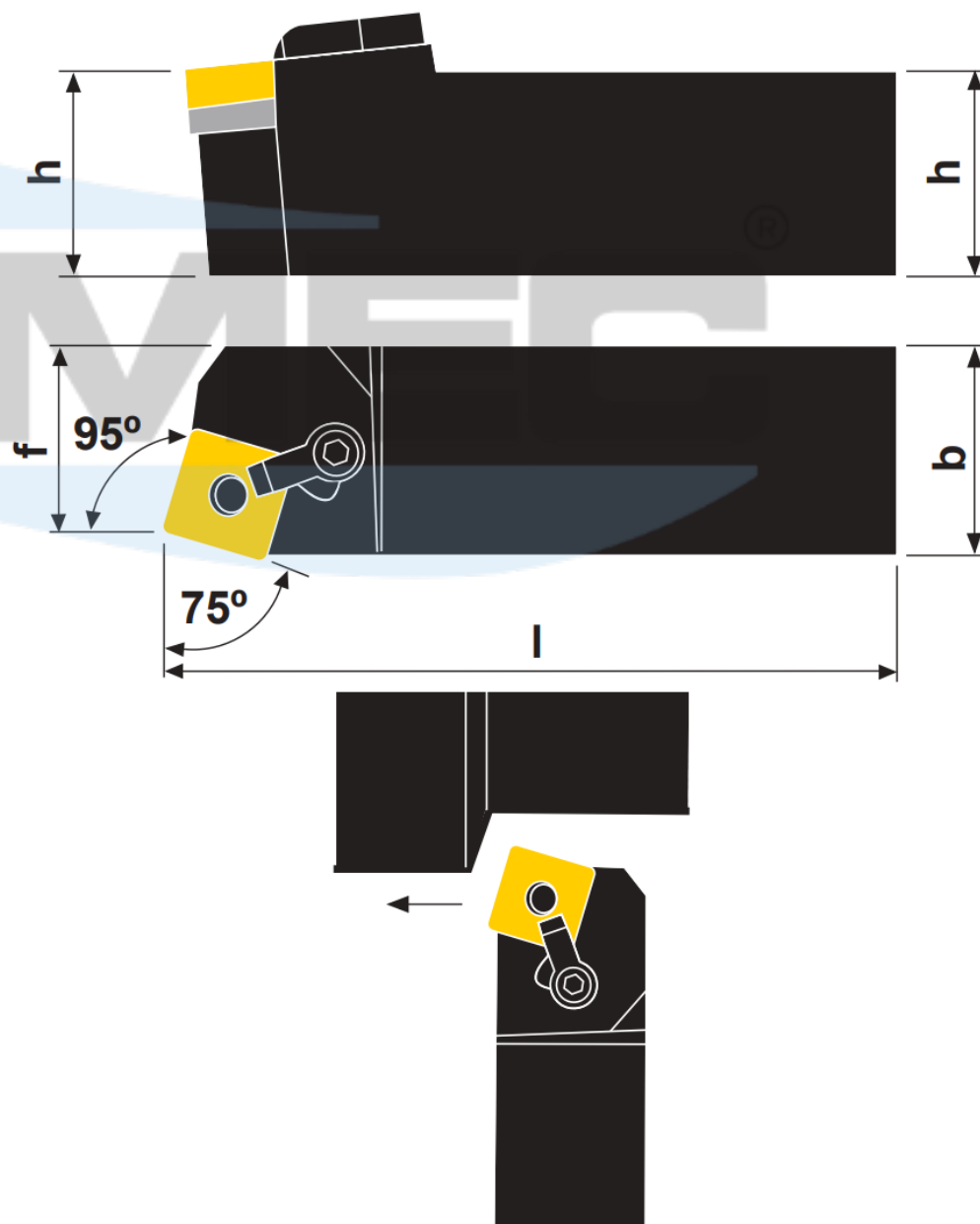
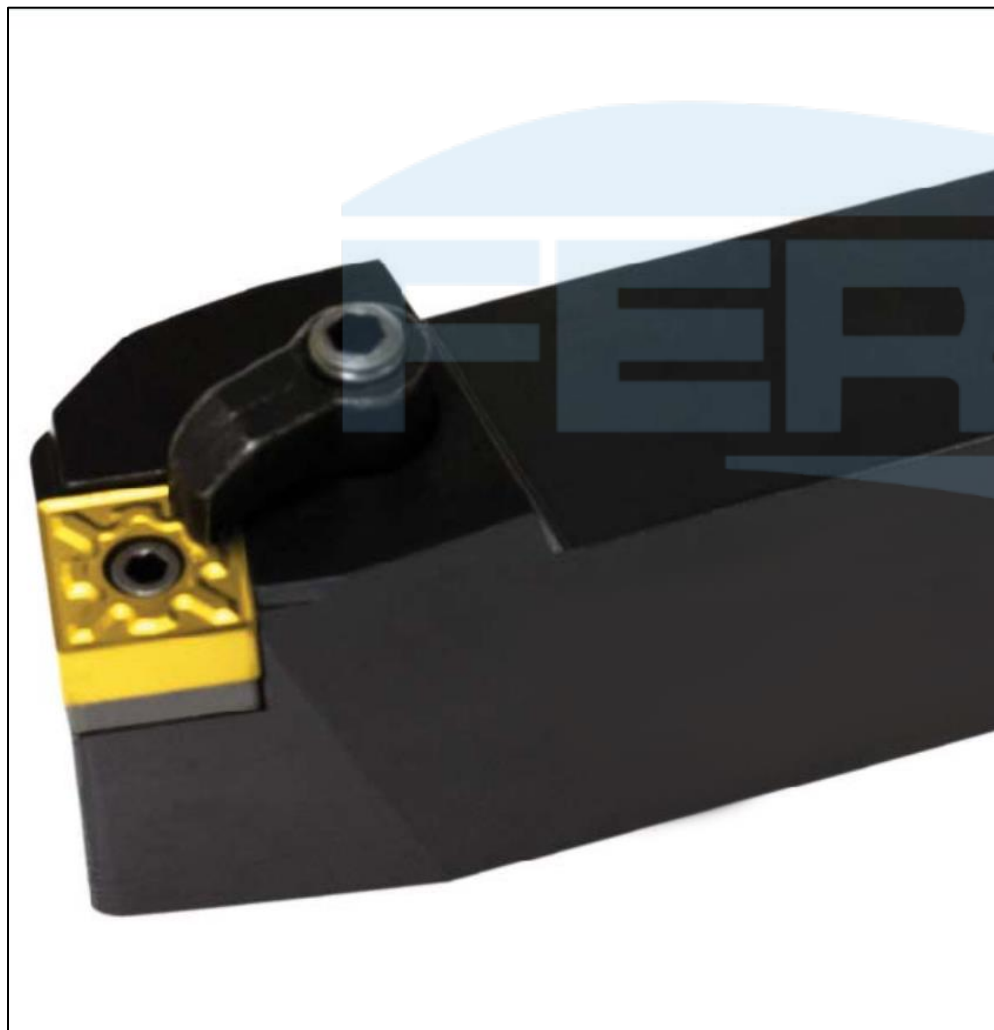
MSDNN

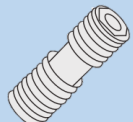
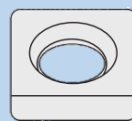
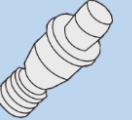
Suporte neutro para torneiar 45° com pastilha negativa quadrada



Ilustração na versão direita

Produtos	Dimensões (mm)				Pastilha	Acessórios				
	h	b	l	f		Grampo	Parafuso	Calço	Pino Paraf. do Calço	Chave Allen
MSDNN 2020 K12	20	20	125	125	SN_1204 SNGN 1204 SNGN 1204	NC-20 NC-23	HT-1	ISSN-423 ISSN-433	NL-46 PS-46	C - 3/32 C - 1/8
MSDNN 2525 M12	25	25	150	150						
MSDNN 3225 P12	32	25	170	170						
MSDNN 3232 P15	32	32	170	170	SN_1506 SNGN 1506	NC-9 NC-12	HT-2	ISSN-543	NL-58 PS-58	C - 1/8 C - 4
MSDNN 4040 S15	40	40	250	250						
MSDNN 3232 P19	32	32	170	170	SN_1906 SNGN 1906	NC-9 NC-30	HT-2	SSN-64C	H312-1C H312-1CH	C - 4
MSDNN 4040 S19	40	40	250	250						

SISTEMA DE FIXAÇÃO DUPLO POR PINO E GRAMPO

MSKNR

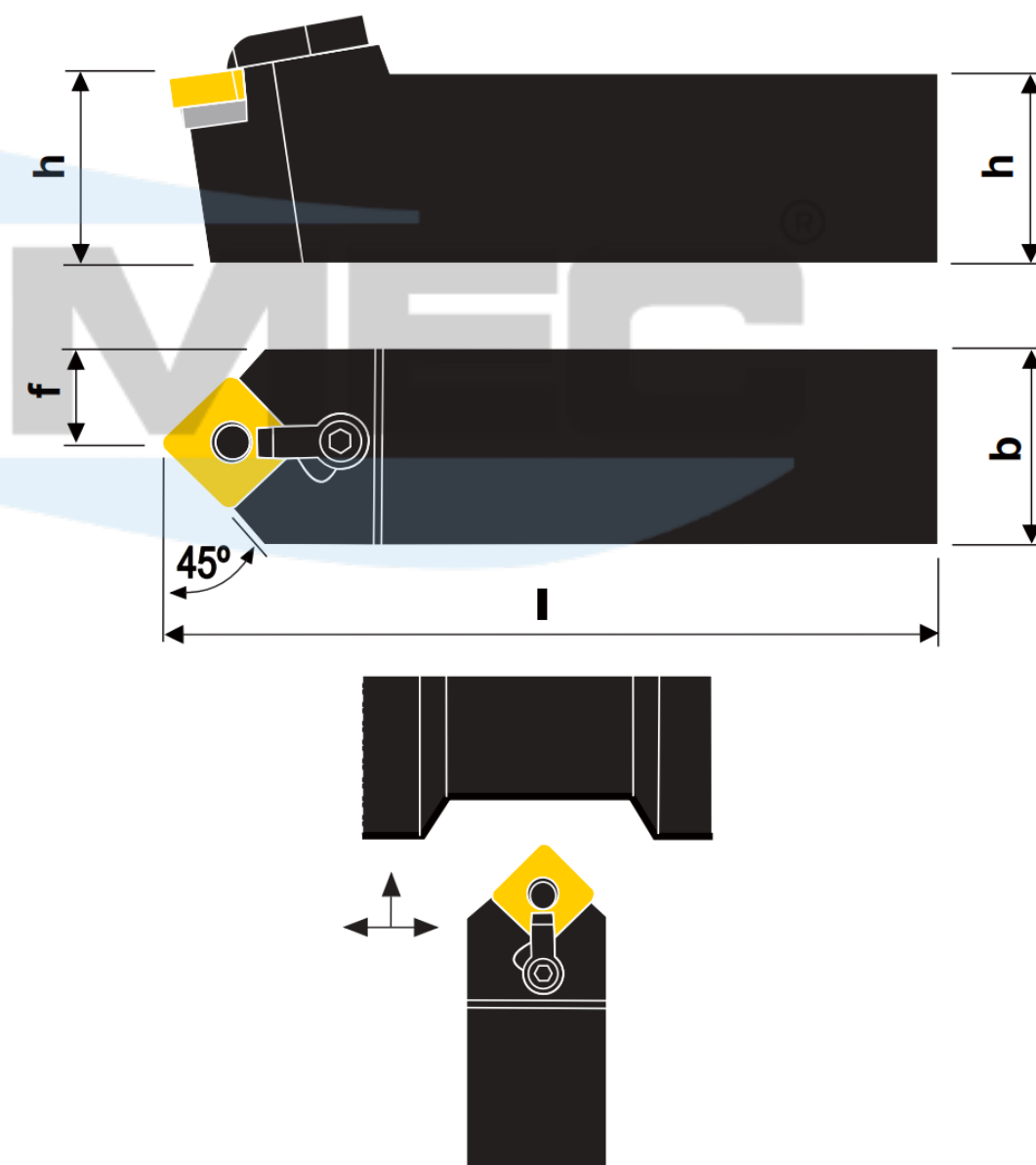
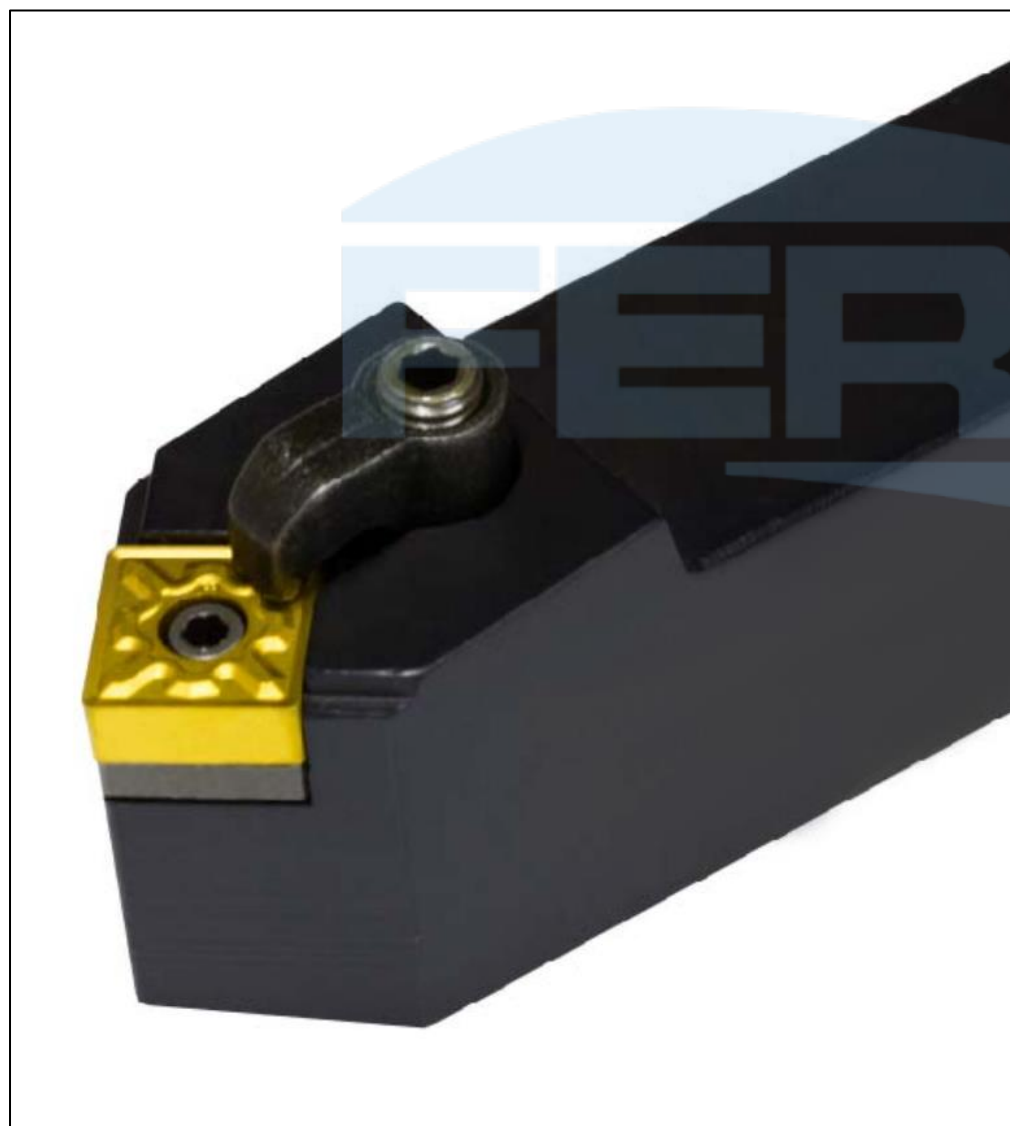
Suporte para facear 75° com pastilha negativa quadrada



Ilustração na versão direita

Produtos	Dimensões (mm)				Pastilha	Acessórios				
	h	b	l	f		Grampo	Parafuso	Calço	Pino Paraf. do Calço	Chave Allen
MSKNR/L 2020 K12	20	20	125	17	SN_1204 SNGN 1204 SNGN 1204	NC-20 NC-23	HT-1	ISSN-423 ISSN-433	NL-46 PS-46	C - 3/32 C - 1/8
MSKNR/L 2525 M12	25	25	150	22						
MSKNR/L 3225 P12	32	25	170	22						
MSKNR/L 3232 P15	32	32	170	27	SN_1506 SNGN 1506	NC-9 NC-12	HT-2	ISSN-543	NL-58 PS-58	C - 1/8 C - 4
MSKNR/L 4040 S15	40	40	250	35						
MSKNR/L 3232 P19	32	32	170	27	SN_1906 SNGN 1906	NC-9 NC-30	HT-2	SSN-64C	H312-1C H312-1CH	C - 4
MSKNR/L 4040 S19	40	40	250	35						

SISTEMA DE FIXAÇÃO DUPLO POR PINO E GRAMPO

MSSNR

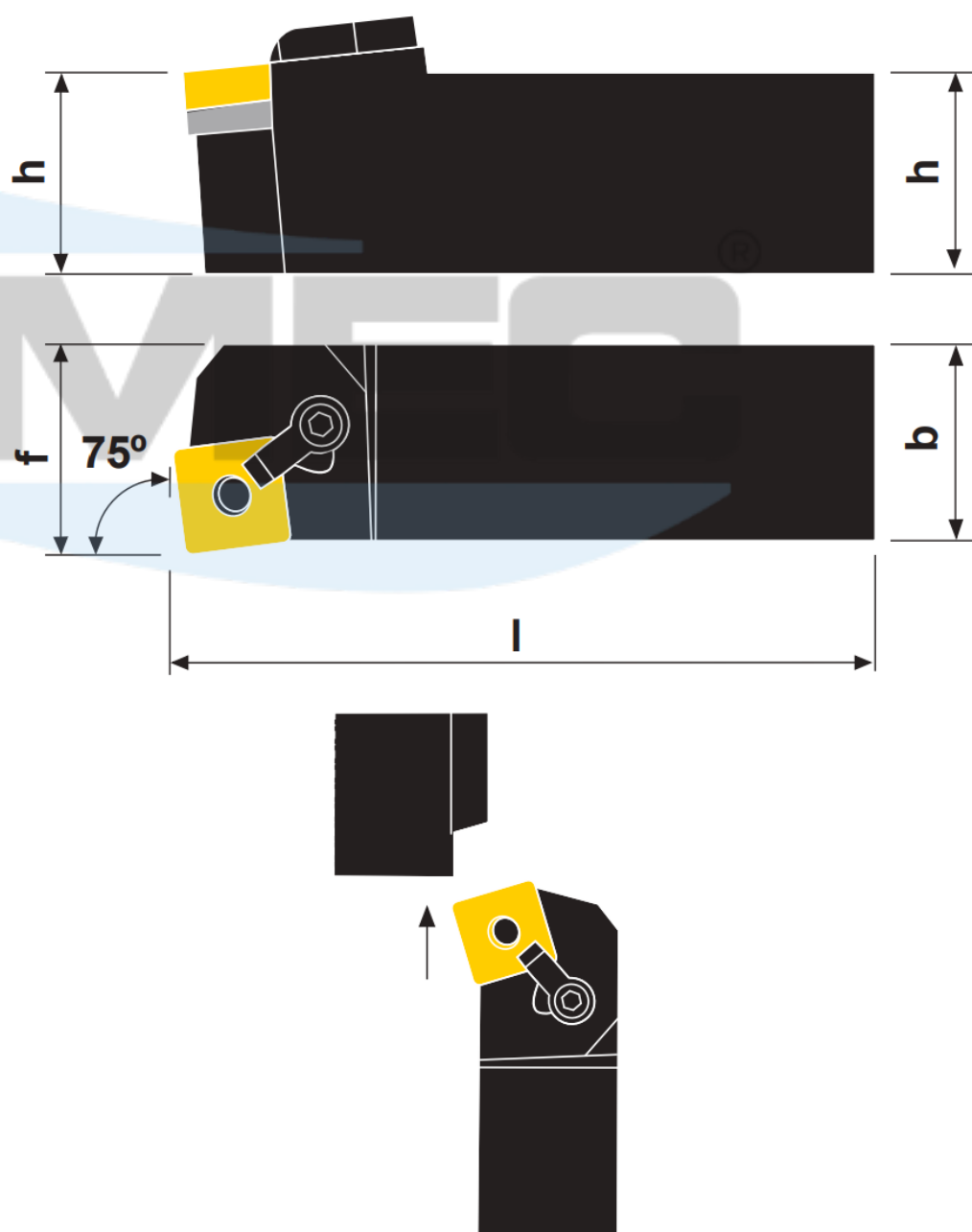
Suporte para torneiar e facear 45° com pastilha negativa quadrada



Ilustração na versão direita

Produtos	Dimensões (mm)				Pastilha	Acessórios				
	h	b	l	f		Grampo	Parafuso	Calço	Pino Paraf. do Calço	Chave Allen
MSSNR 2020 K12	20	20	125	25	SN_1204 SNGN 1204 SNGN 1203	HL1813	CTM617	MS1204	ML0625	M - 2,5 M - 3,0
MSSNR 2525 M12	25	25	150	32						
MSSNR 3225 P12	32	25	170	32						
MSSNR 3232 P15	32	32	170	25	SN_1506 SNGN 1506	NC-9 NC-12	HT-2	ISSN-543	NL-58 PS-58	C - 1/8 C - 4
MSSNR 4040 S15	40	40	250	35						
MSSNR 3232 P19	32	32	170	40	SN_1906 SNGN 1906	NC-9 NC-30	HT-2	SSN-64C	H312-1C H312-1CH	C - 4
MSSNR 4040 S19	40	40	250	50						

SISTEMA DE FIXAÇÃO DUPLO POR PINO E GRAMPO

MTFNR

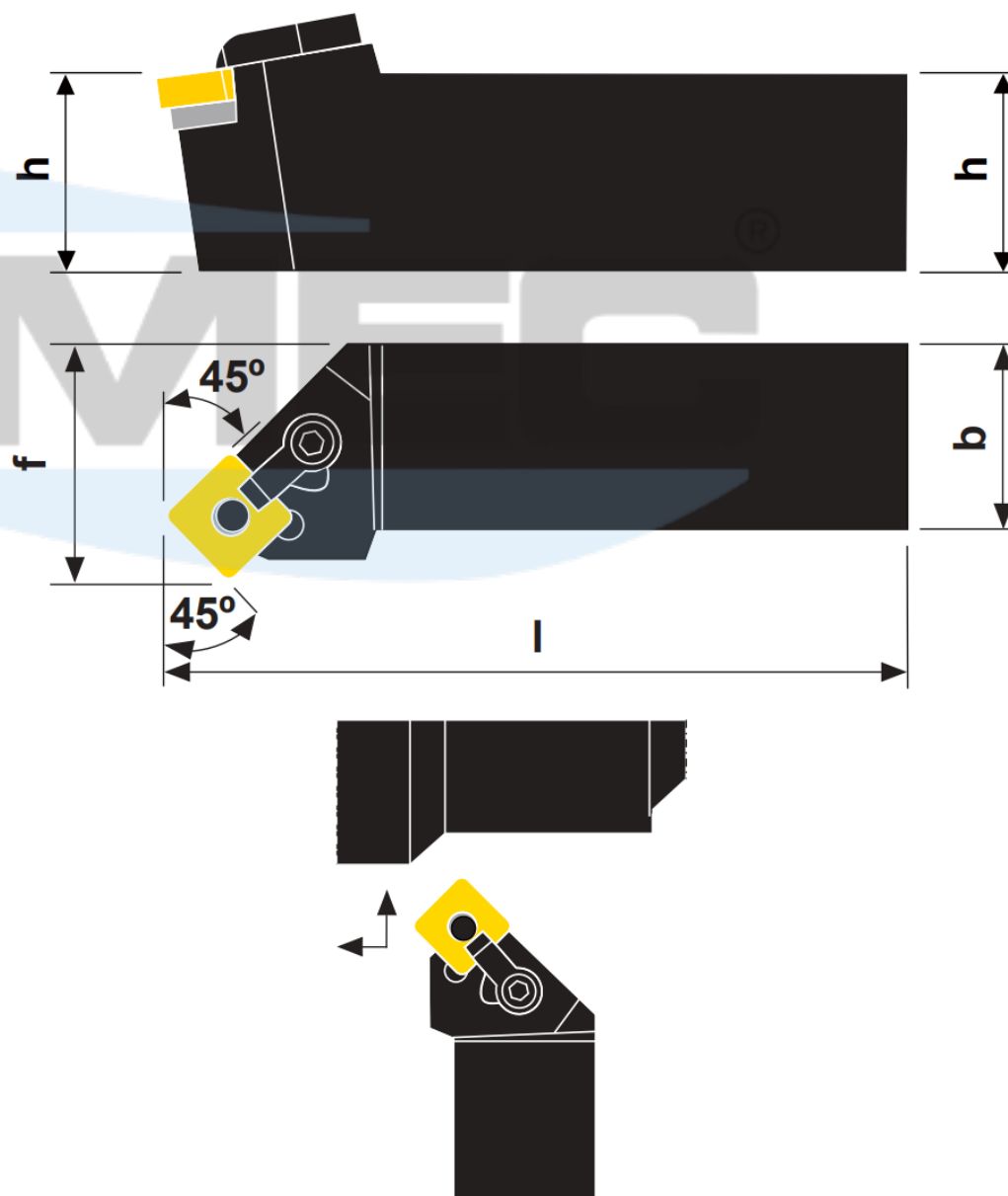
Suporte para facear 91° com pastilha negativa triangular







Ilustração na versão direita

Produtos	Dimensões (mm)				Pastilha	Acessórios				
	h	b	l	f			 Grampo	 Parafuso	 Calço	 Pino Paraf. do Calço
MTFNR/L 2020 K16	20	20	125	25	TN_1604 TNGN 1604	NC-20 NC-23	HT-1	STN-32M	H318-1C H318-1CH	C - 2 C - 1/8
MTFNR/L 2525 M16	25	25	150	32						
MTFNR/L 3225 P16	32	25	170	32						
MTFNR/L 2525 M22	25	25	150	32	TN_2204 TNGN 2204	NC-9 NC-12	HT-2	STN-43C	H308-1C H308-1CH	C - 2,5 C - 4
MTFNR/L 3232 P22	32	32	170	40						

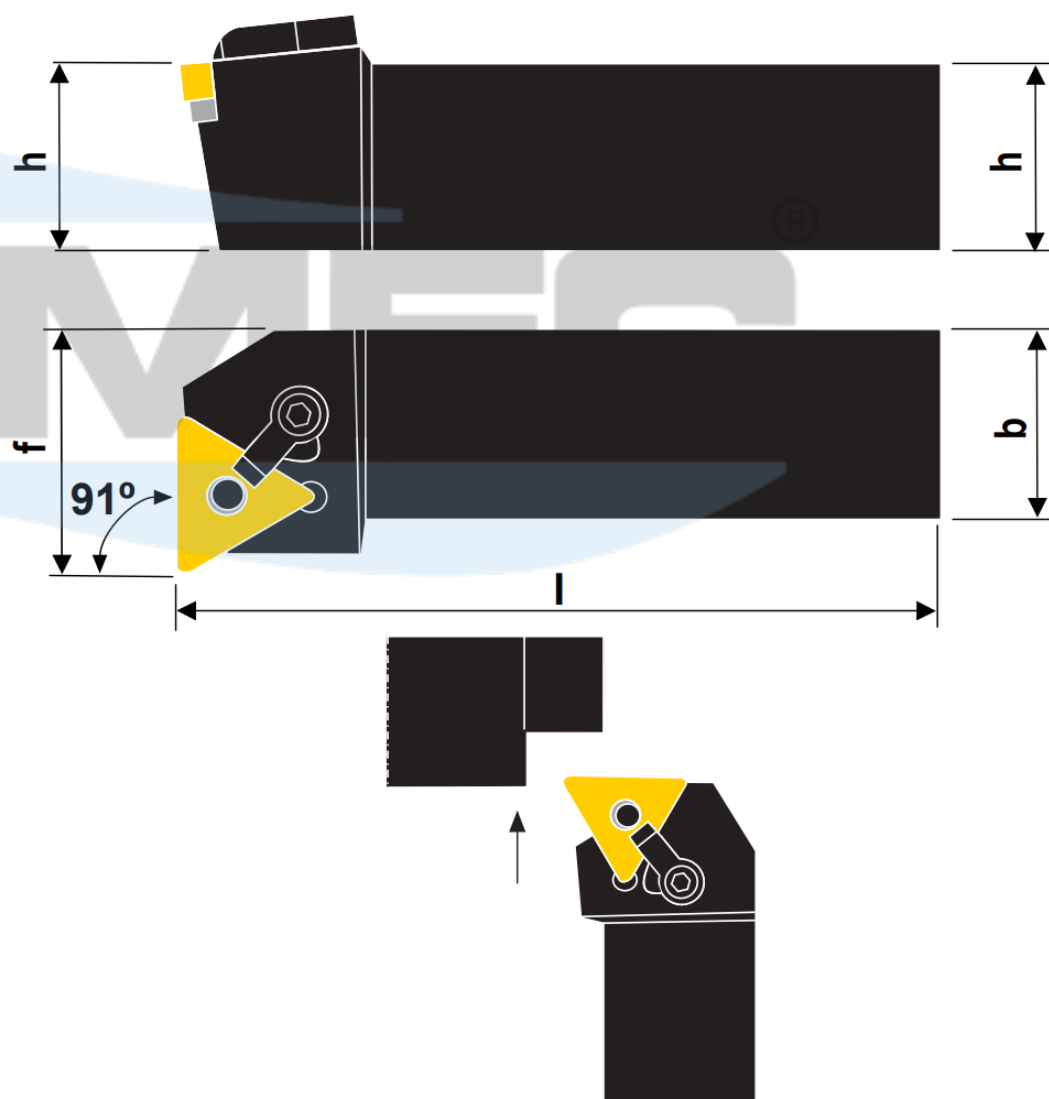
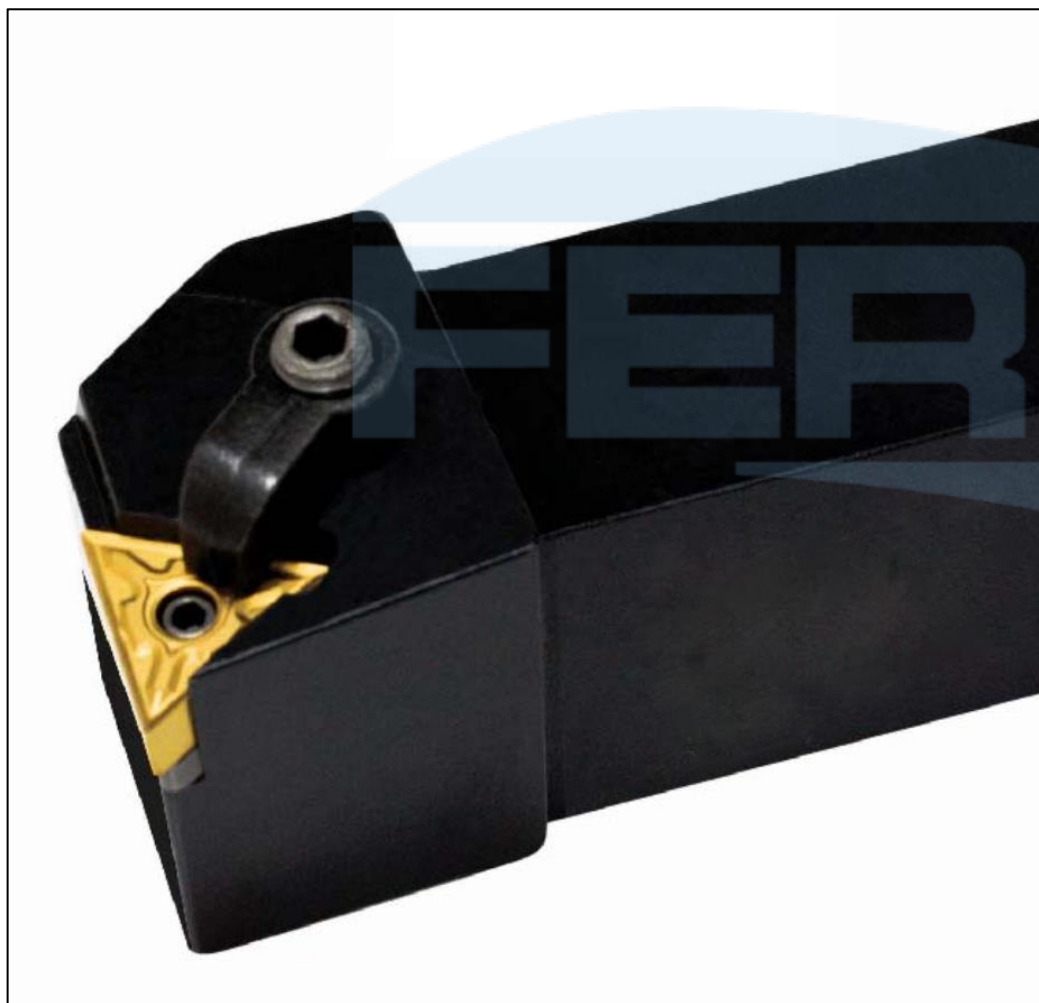
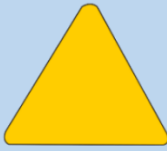
SISTEMA DE FIXAÇÃO DUPLO POR PINO E GRAMPO

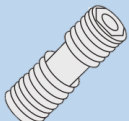
MTGNR

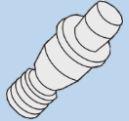
Suporte para torneiar 91° com pastilha negativa triangular









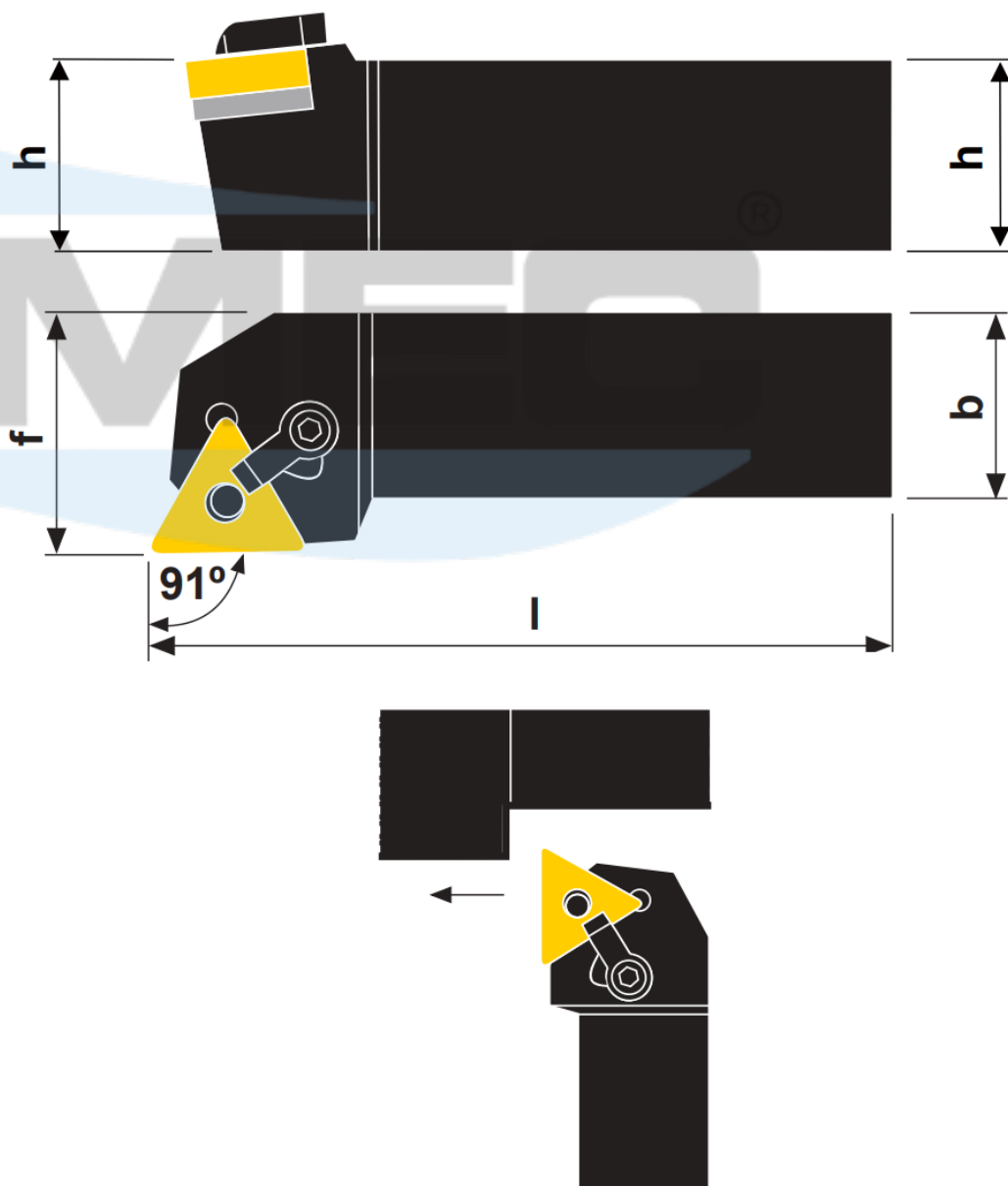
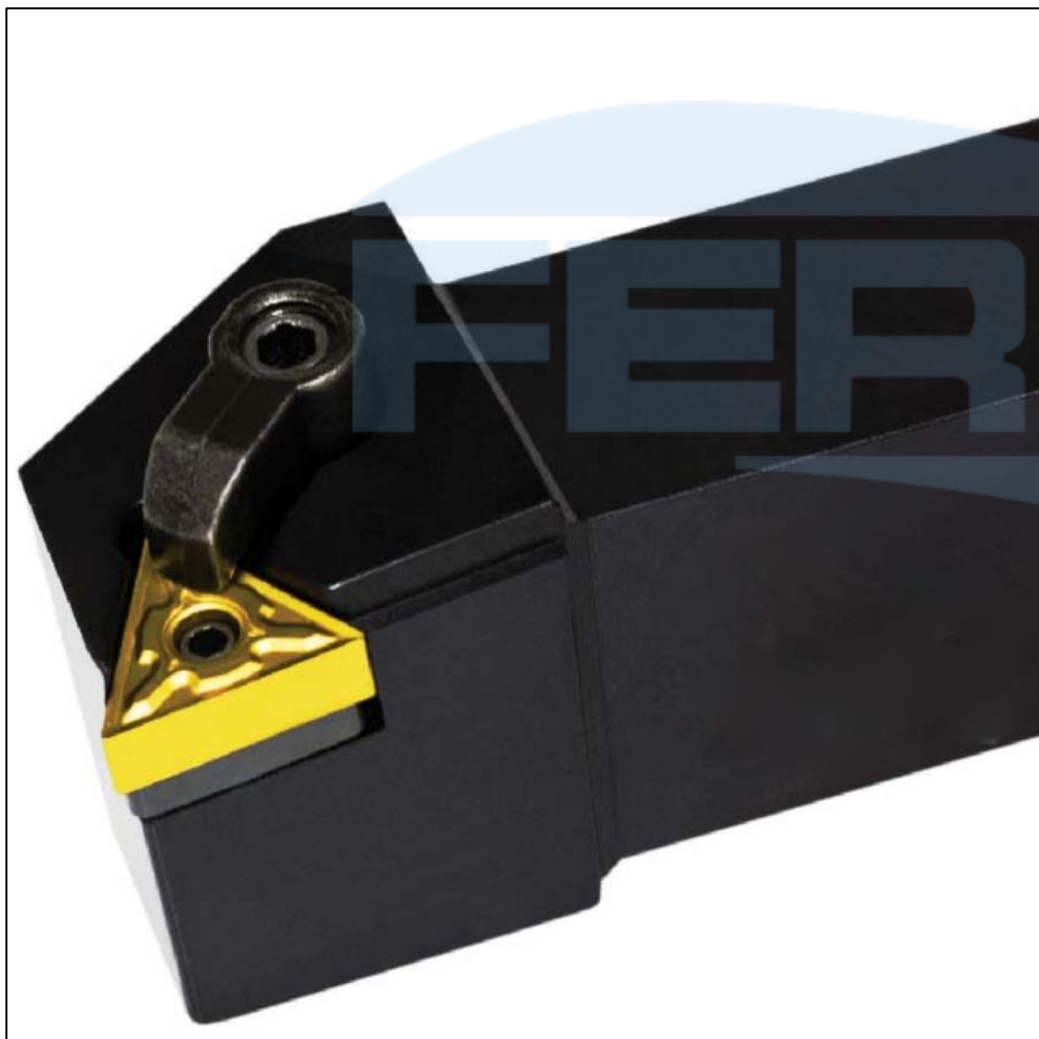
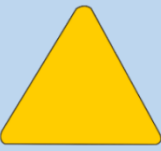

Ilustração na versão direita

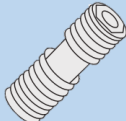
Produtos	Dimensões (mm)				Pastilha	Acessórios				
	h	b	l	f		Grampo	Parafuso	Calço	Pino Paraf. do Calço	Chave Allen
MTGNR/L 2020 K16	20	20	125	25	 TN_1604 TNGN 1604	 NC-20 NC-23	 HT-1	 STN-32M	 H318-1C H318-1CH	 C - 2,0 C - 1/8
MTGNR/L 2525 M16	25	25	150	32						
MTGNR/L 3225 P16	32	25	170	32						
MTGNR/L 2525 M22	25	25	150	32	 TN_2204 TNGN 2204	 NC-9 NC-12	 HT-2	 STN-43C	 H308-1C H308-1CH	 C - 2,5 C - 4,0
MTGNR/L 3232 P22	32	32	170	40						

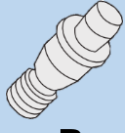
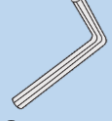
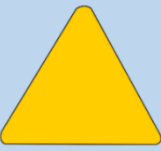
SISTEMA DE FIXAÇÃO DUPLO POR PINO E GRAMPO

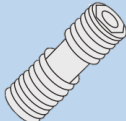
MTSNR

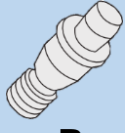
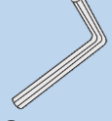
Suporte para torneiar e facear 45° com pastilha negativa 60°







Ilustração na versão direita

Produtos	Dimensões (mm)				Pastilha	Acessórios				
	h	b	l	f			 Grampo	 Parafuso	 Calço	 Pino Paraf. do Calço
MTSNR/L 2020 K16	20	20	125	25	TNMG 1604_Q-RM	NC-20	HT-3	TN16/HM-U	H318-1C	M - 2,0
MTSNR/L 2525 M16	25	25	150	32						
MTSNR/L 2525 M22	32	25	150	32	TNMG 2204_Q-RM	NC-9	HT-2	TN22/HM-U	H308-1C	C - 2,5 C - 4,0
MTSNR/L 3232 P22	32	32	170	40						
MTSNR/L 2525 P27	25	25	150	32	TNMG 2706_Q-RM	NC-9	HT-2	-	NL-58	C-4 / C- 1/8

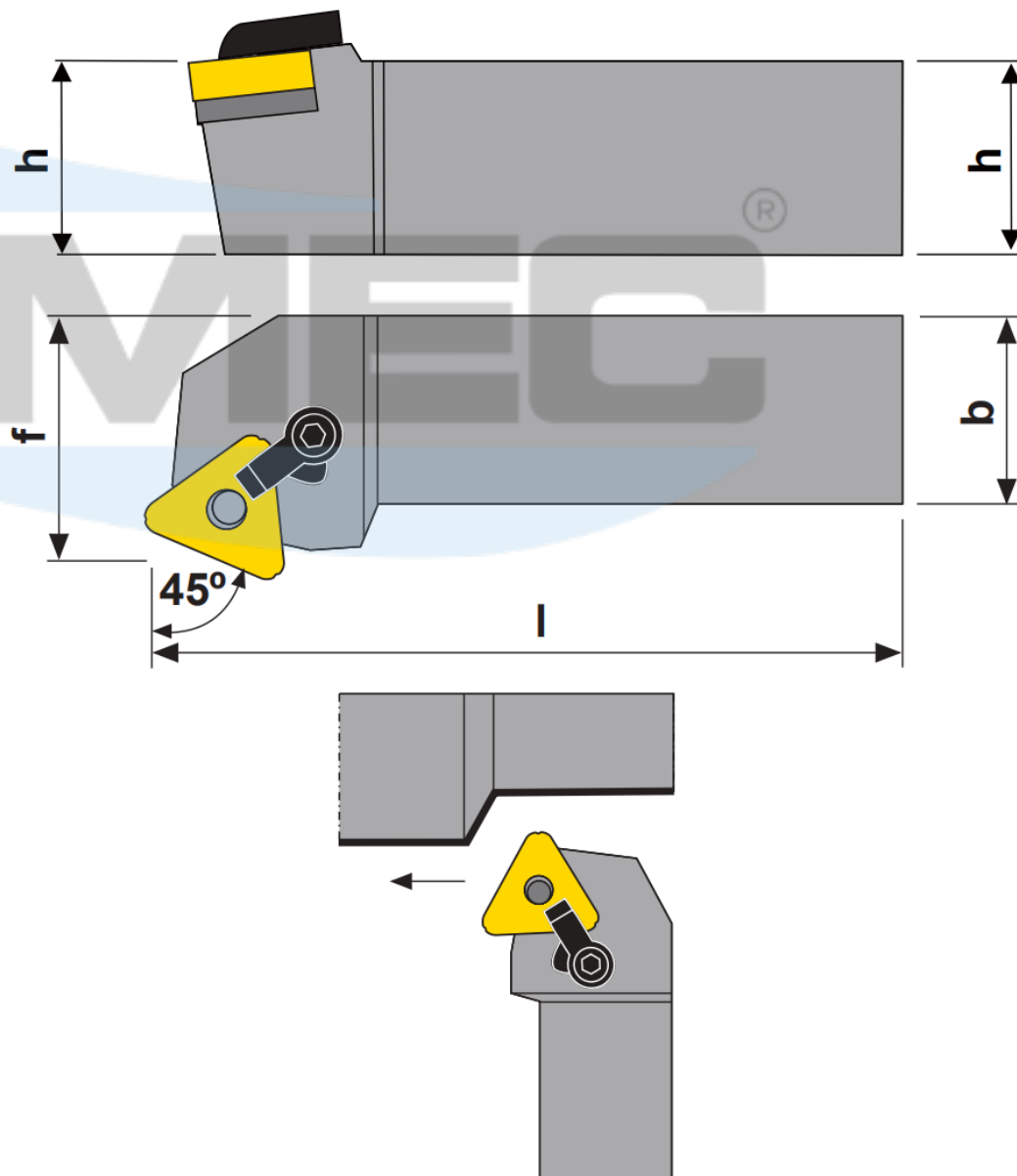
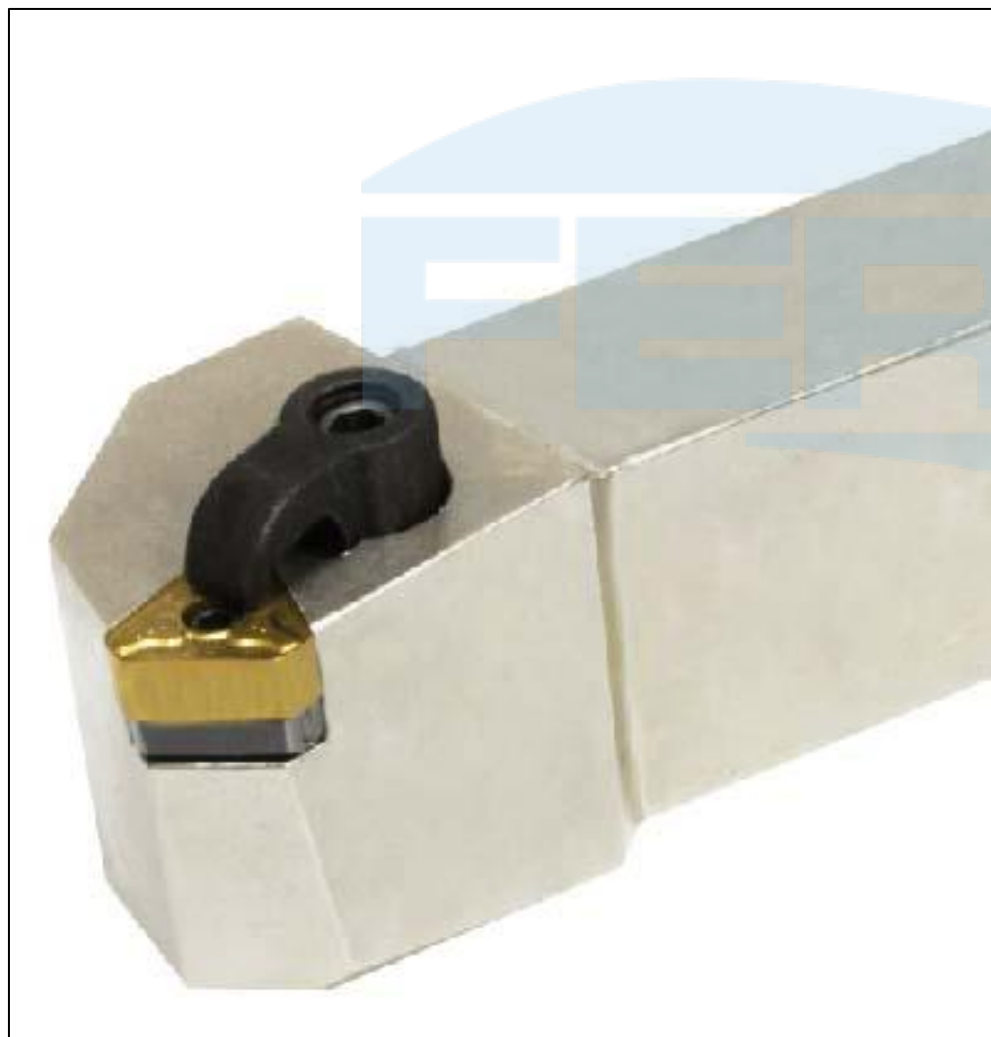
SISTEMA DE FIXAÇÃO DUPLO POR PINO E GRAMPO

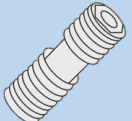
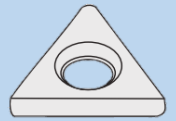
MVJNR

Suporte para torneiar e facear 45° com pastilha negativa 60°





Ilustração na versão direita

Produtos	Dimensões (mm)				Pastilha 	Acessórios				
	h	b	l	f		Grampo	Parafuso	Calço	Pino Paraf. do Calço	Chave Allen
MVJNR/L 2020 K16	20	20	125	25	VN_1604 VNGN 1604	HL2114	ML0625	MV1603	CTM513	M - 2,0 M - 3,0
MVJNR/L 2525 M16	25	25	150	32						
MVJNR/L 3225 P16	32	25	170	32						
MVJNR/L 4040 S16	40	40	250	50						

SISTEMA DE FIXAÇÃO DUPLO POR PINO E GRAMPO

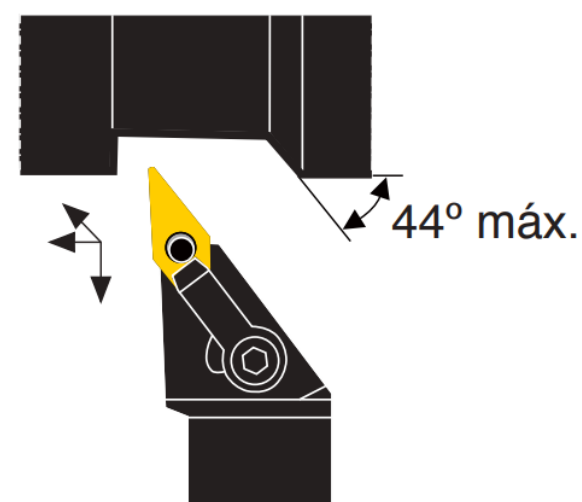
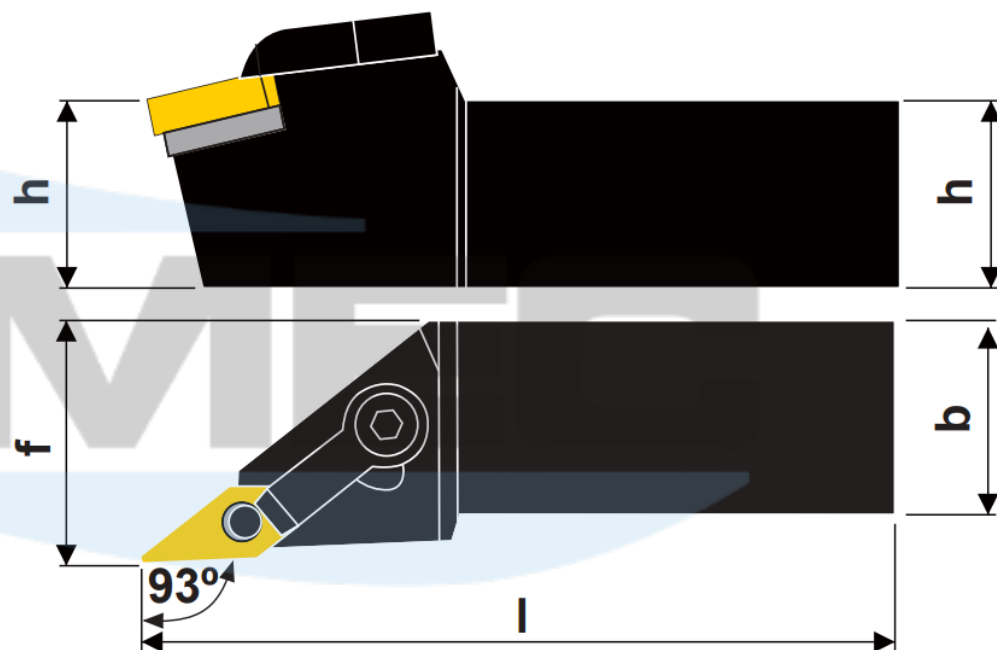
MVVNN

Suporte para tornear e facear 45° com pastilha negativa 60°





Ilustração na versão direita

Produtos	Dimensões (mm)				Pastilha	Acessórios				
	h	b	l	f			 Grampo	 Parafuso	 Calço	 Pino Paraf. do Calço
MVVNN 2020 K16	20	20	125	10	VN_1604 VNGN 1604	NC-23	HT-1	IVSN-322	H318-1C H318-1CH	M - 2,0 M - 1/8
MVVNN 2525 M16	25	25	150	12,5						
MVVNN 3225 P16	32	25	170	12,5						
MVVNN 4040 S16	40	40	250	20						

SISTEMA DE FIXAÇÃO DUPLO POR PINO E GRAMPO

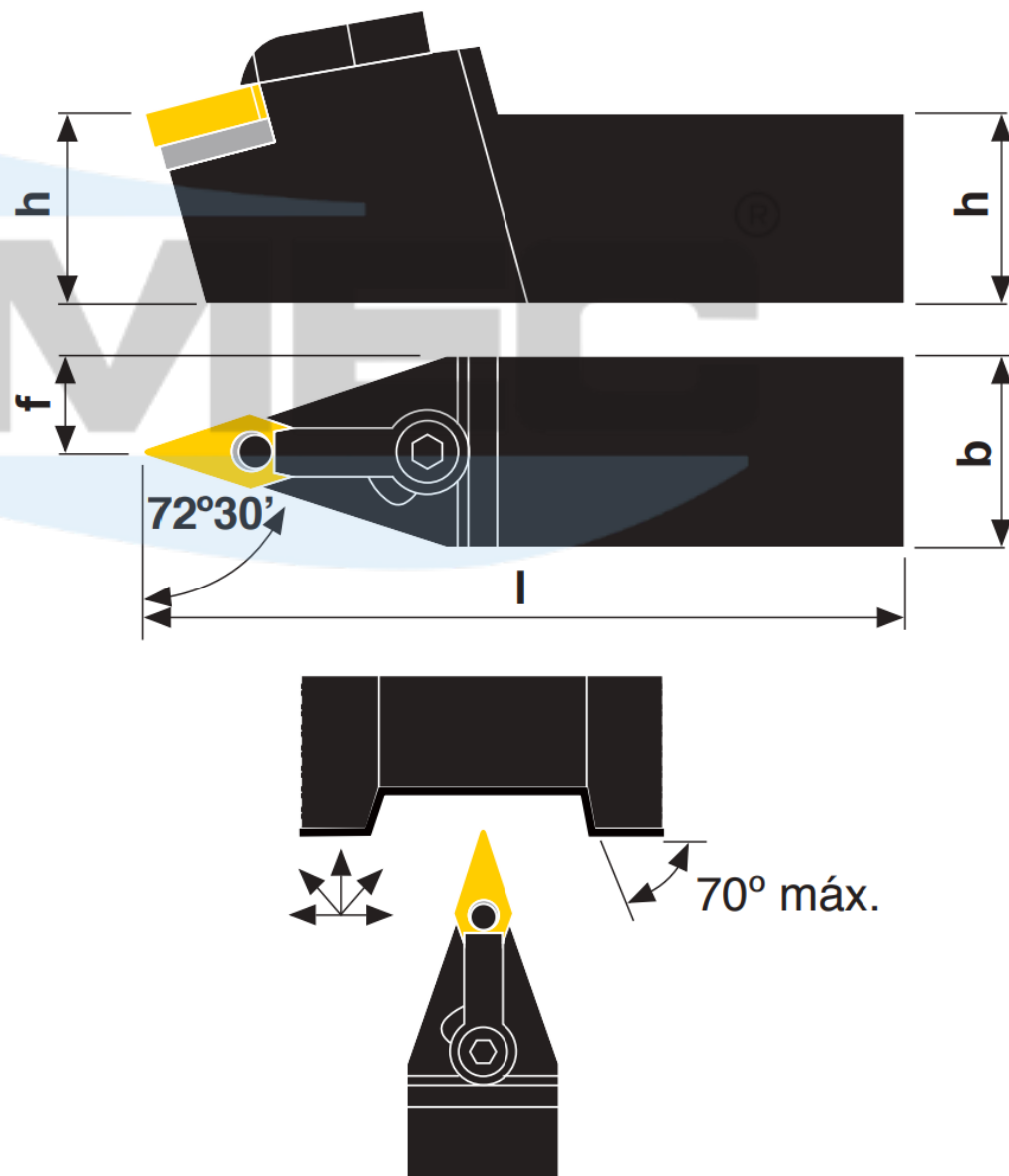
MWLNR-M2

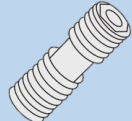
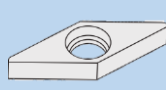
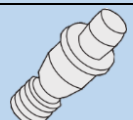
Suporte para tornear 95° com pastilha trigonal negativa 60°



Ilustração na versão direita

Produtos	Dimensões (mm)				Pastilha	Acessórios				
	h	b	l	f		Grampo	Parafuso	Calço	Pino Paraf. do Calço	Chave Allen
MWLNR/L 1616 H06-M2	16	16	100	21	WN_0604	NC-20	HT-1	5322 331-06	H318-1C	C - 2 C - 1/8
MWLNR/L 2020 K06-M2	20	20	125	25						
MWLNR/L 2525 M06-M2	25	25	150	32						
MWLNR/L 2020 K08-M2	20	20	125	25	WN_0804	NC-20	HT-1	5322 331-07	H308-1C	C - 2,5 C - 1/8
MWLNR/L 2525 M08-M2	25	25	150	32						
MWLNR/L 3232 P08-M2	32	32	170	40						
MWLNR/L 4040 S08-M2	40	40	250	50						

SISTEMA DE FIXAÇÃO POR CUNHA-GRAMPO

MTENN

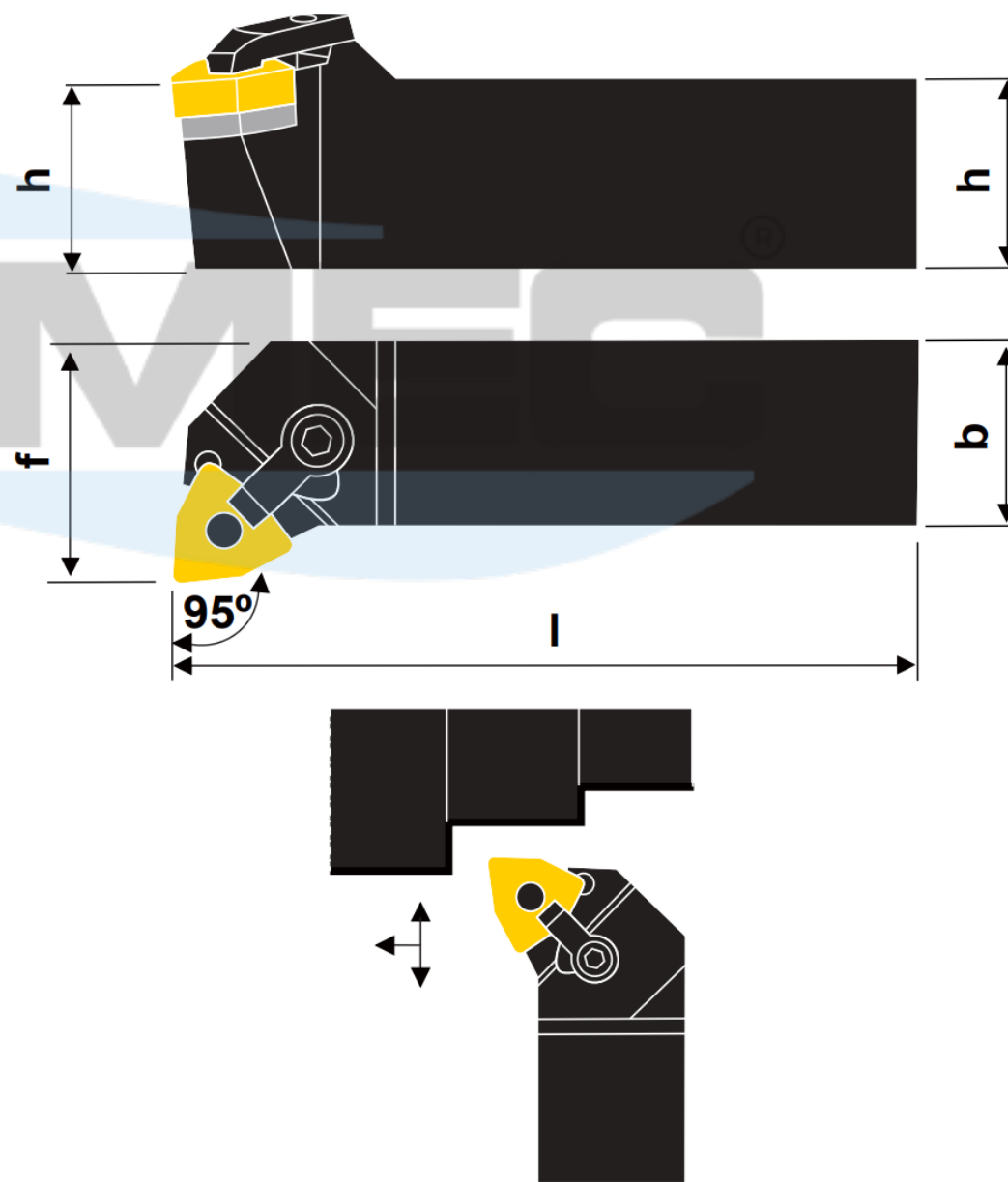
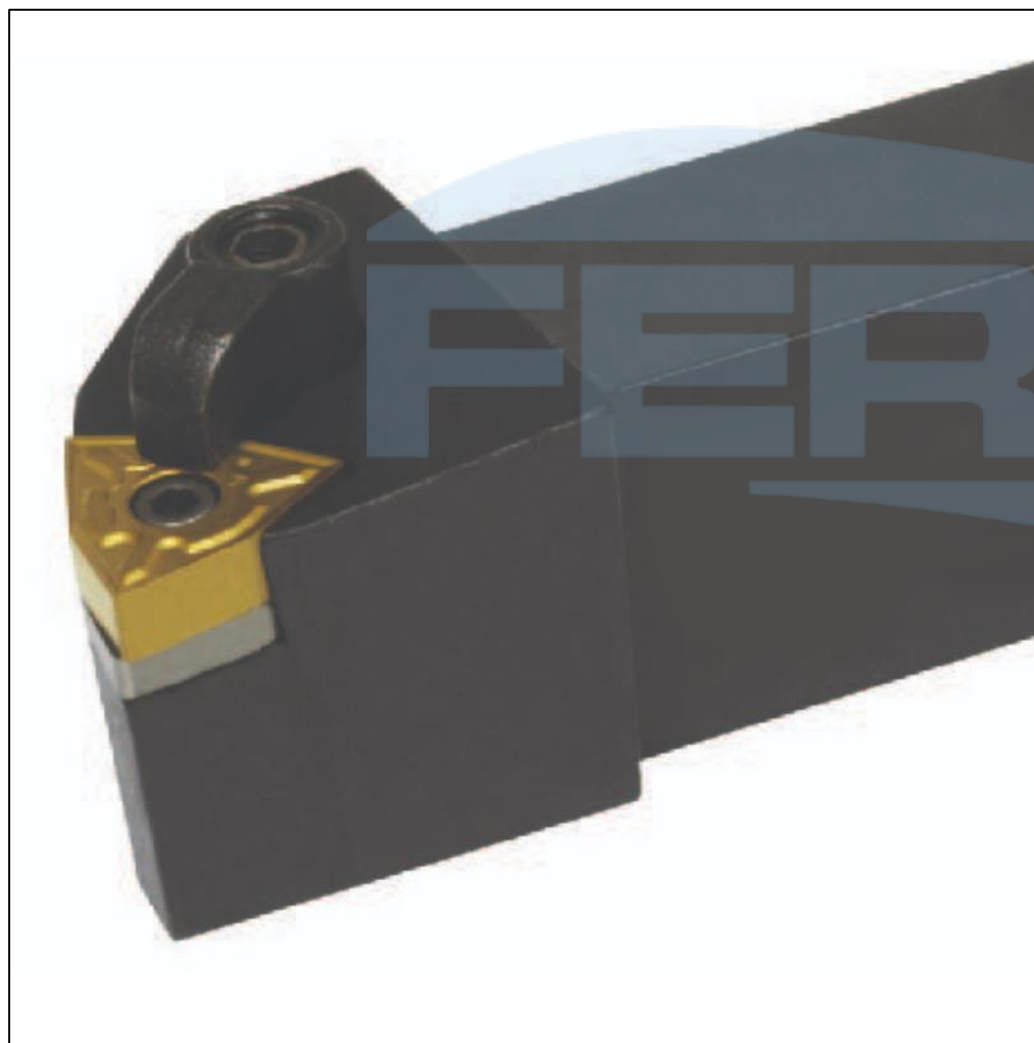
Suporte neutro 60° com pastilha negativa triangular



Ilustração na versão direita







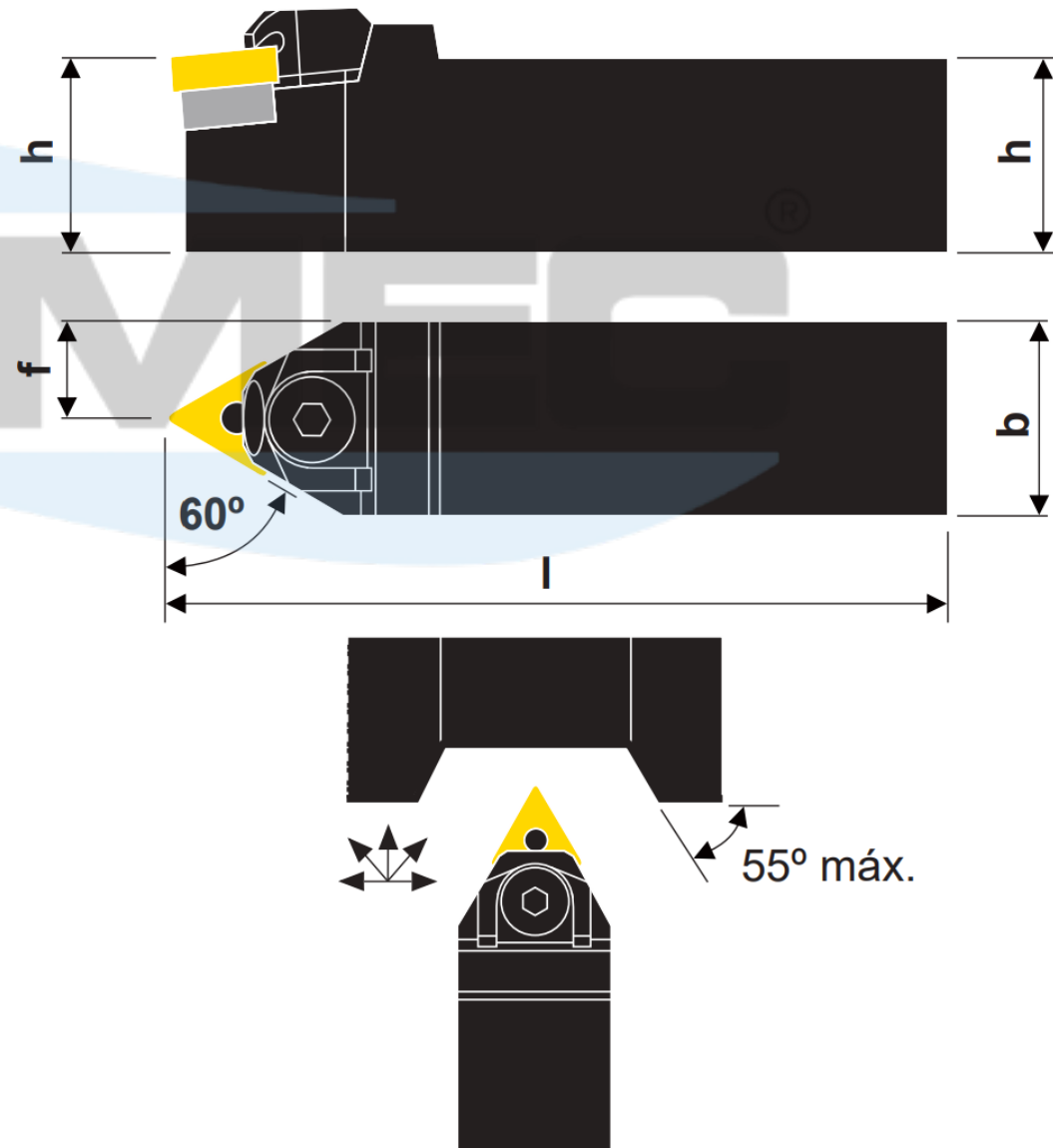
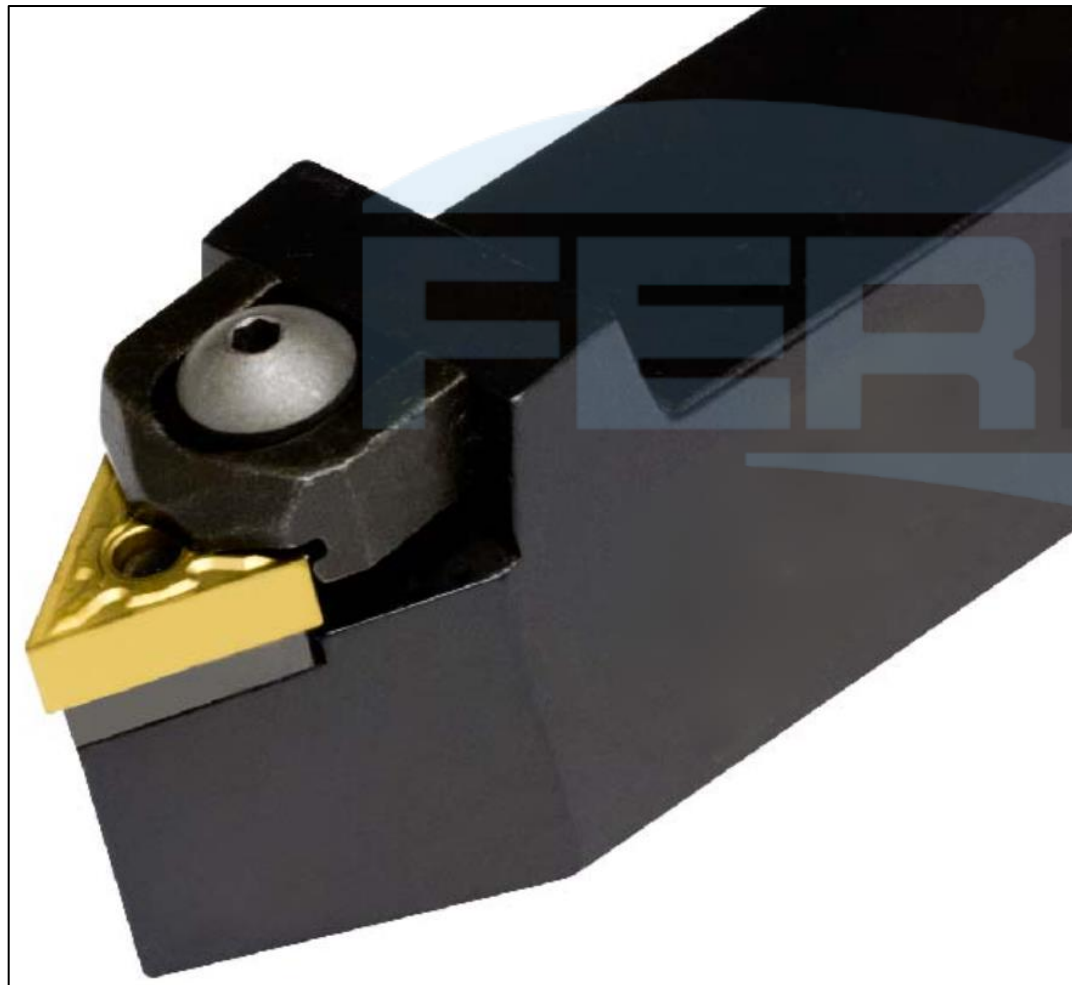

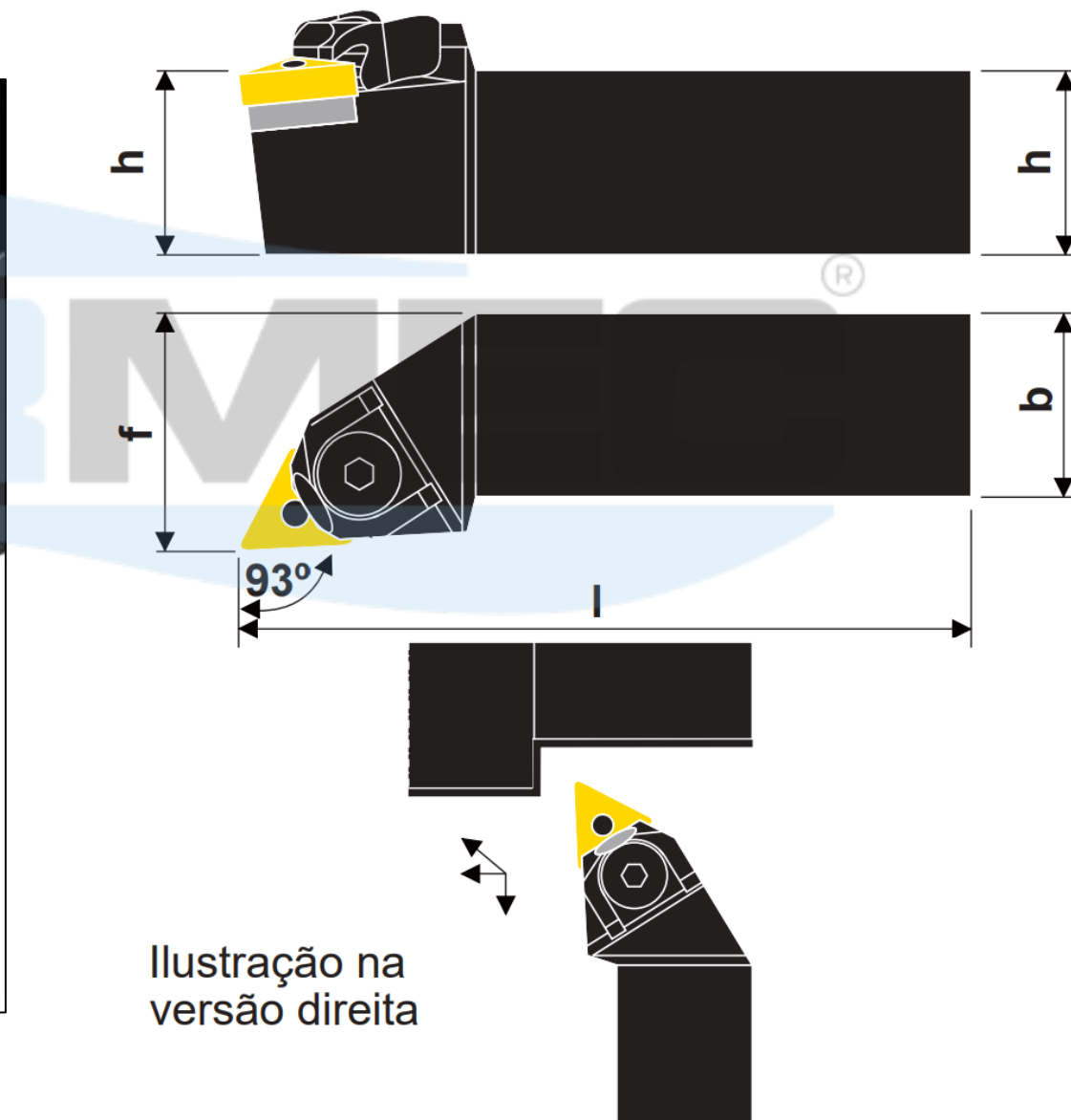
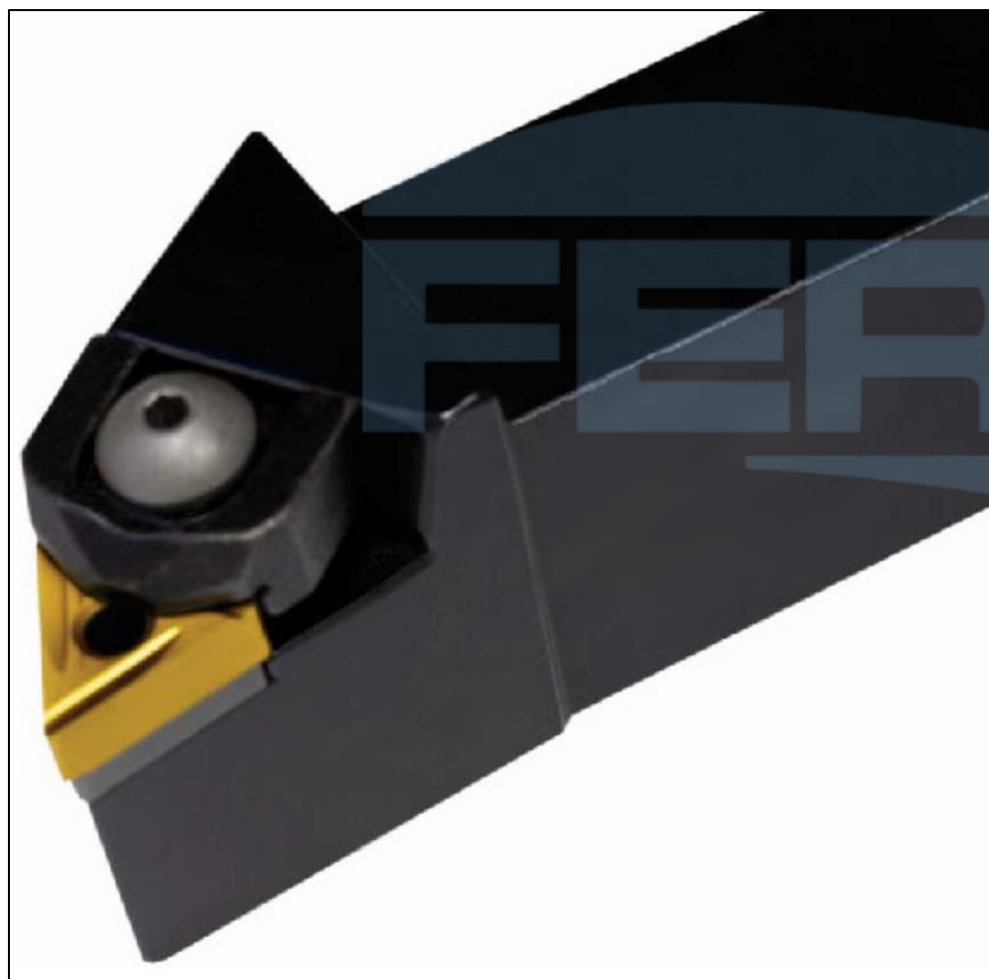

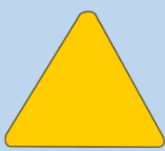
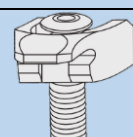

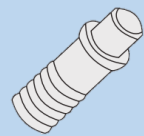

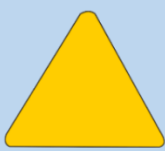
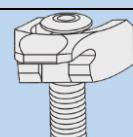

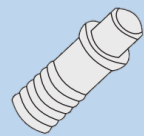
Produtos	Dimensões (mm)				Pastilha	Acessórios				
	h	b	l	f		Cj. Grampo-Parafuso	Parafuso do Pino	Calço	Pino	Chave Allen
MTENN 2020 K16	20	20	125	10	TN_1604	170.38-820-1	3212 010-206	170.3-852	5312 021-02	C - 2,5
MTENN 2525 M16	25	25	150	12,5						
MTENN 3225 P16	32	25	170	12,5						
MTENN 2525 M22	25	25	150	12,5	TN_2204	170.38-821-1	3212 010-255	170.3-855	181.38-840	C- 3,0
MTENN 3225 P22	32	25	170	12,5						
MTENN 3232 P22	32	32	170	16						

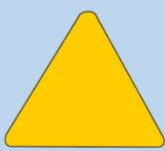
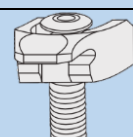
SISTEMA DE FIXAÇÃO POR CUNHA-GRAMPO

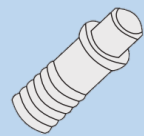
MTJNR

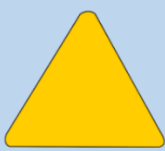
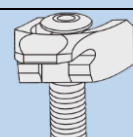
Suporte para torneiar 93° com pastilha triangular negativa

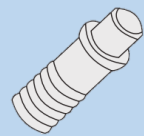

Produtos	Dimensões (mm)				Pastilha	Acessórios					
	h	b	l	f			 Cj. Grampo-Parafuso	 Parafuso do Pino	 Calço	 Pino	 Chave Allen
MTJNR/L 1616 H16	16	16	100	20	TN_1604		 170.38-820-1	 3212 010-206	 170.3-852	 5312 021-02	 C - 2,5
MTJNR/L 2020 K16	20	20	125	25							
MTJNR/L 2525 M16	25	25	150	32							
MTJNR/L 3225 P16	32	32	170	32							
MTJNR/L 4040 S16	40	40	250	50	TN_2204		 170.38-821-1	 3212 010-255	 170.3-855	 181.38-840	 C - 3
MTJNR/L 2525 M22	25	25	150	32							
MTJNR/L 3225 P22	32	32	170	32	TN_2706		 170.38-821-1	 M5X16 DIN 912	 170.3-854	 5313 021-04	 C - 3 C - 4
MTJNR/L 3232 P22	32	32	170	40							
MTJNR/L 4040 S22	40	40	250	50							
MTJNR/L 3232 P27	32	32	170	40							
MTJNR/L 4040 S27	40	40	250	50							

SISTEMA DE FIXAÇÃO POR CUNHA-GRAMPO

MWLNR

Suporte para torneiar 95° com pastilha trigonal negativa 80°







Ilustração na versão direita

Produtos	Dimensões (mm)				Pastilha	Acessórios				
	h	b	l	f						
MWLNR/L 1616 H06	16	16	100	21	WN_0604	5431 125-011	5512 030-03	5322 331-06	5313 022-02	C - 2,5
MWLNR/L 2020 K06	20	20	125	25						
MWLNR/L 2525 M06	25	25	150	32						
MWLNR/L 2020 K08	20	20	125	25	WN_0804	5431 125-021	3212 010-255	5322 331-07	5313 022-03	C- 3,0
MWLNR/L 2525 M08	25	25	150	32						
MWLNR/L 3232 P08	32	32	170	40						
MWLNR/L 4040 S08	40	40	250	50						

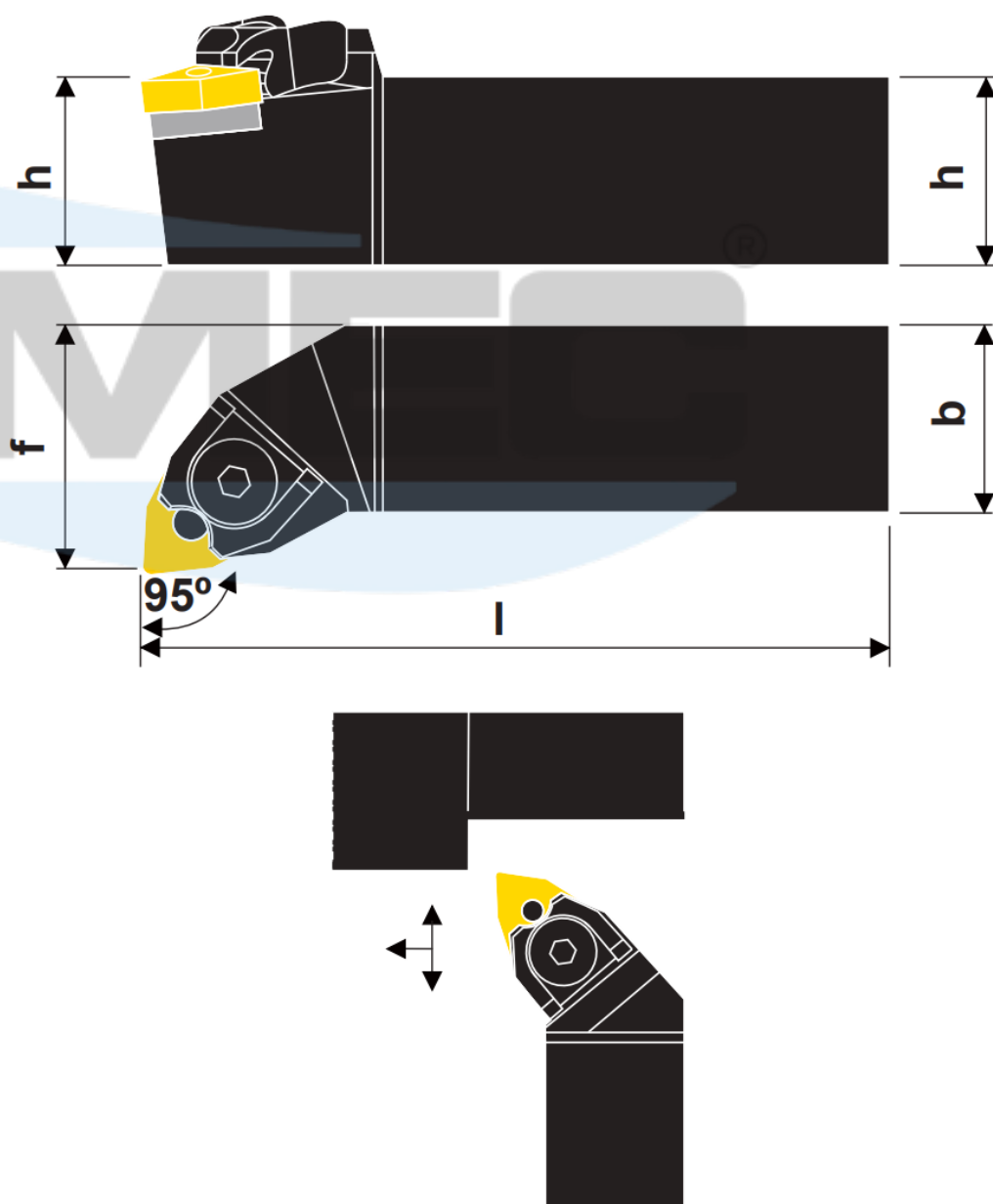
SISTEMA DE FIXAÇÃO POR PARAFUSO TORX

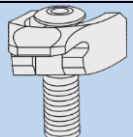
SCACR

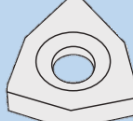
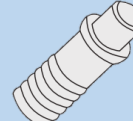
Suporte para torneiar a 93° e facear a 97° com pastilha positiva 80°







Ilustração na versão direita

Produtos	Dimensões (mm)					Pastilha 	Acessórios			
	h	b	l	f	f1		 Parafuso Torx	 Calço	 Parafuso do Calço	 Chave Torx/Allen
SCACR/L 1010 M06	10	10	150	10	-	CC_0602	5513 020-03	-	-	T7-B
SCACR/L 1212 M09	12	12	150	12	14	CC_09T3	5513 020-09	-	-	T15-B

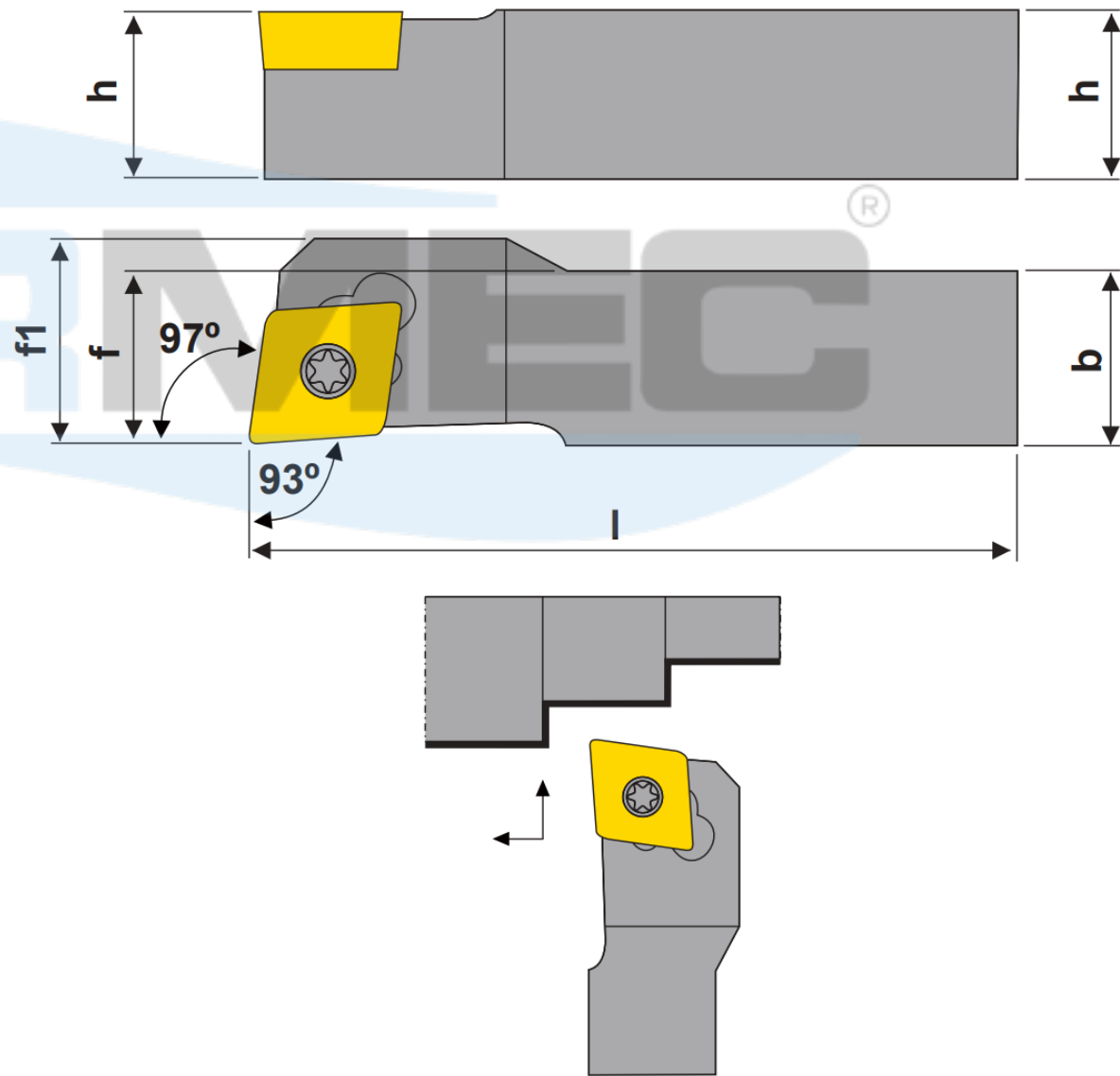
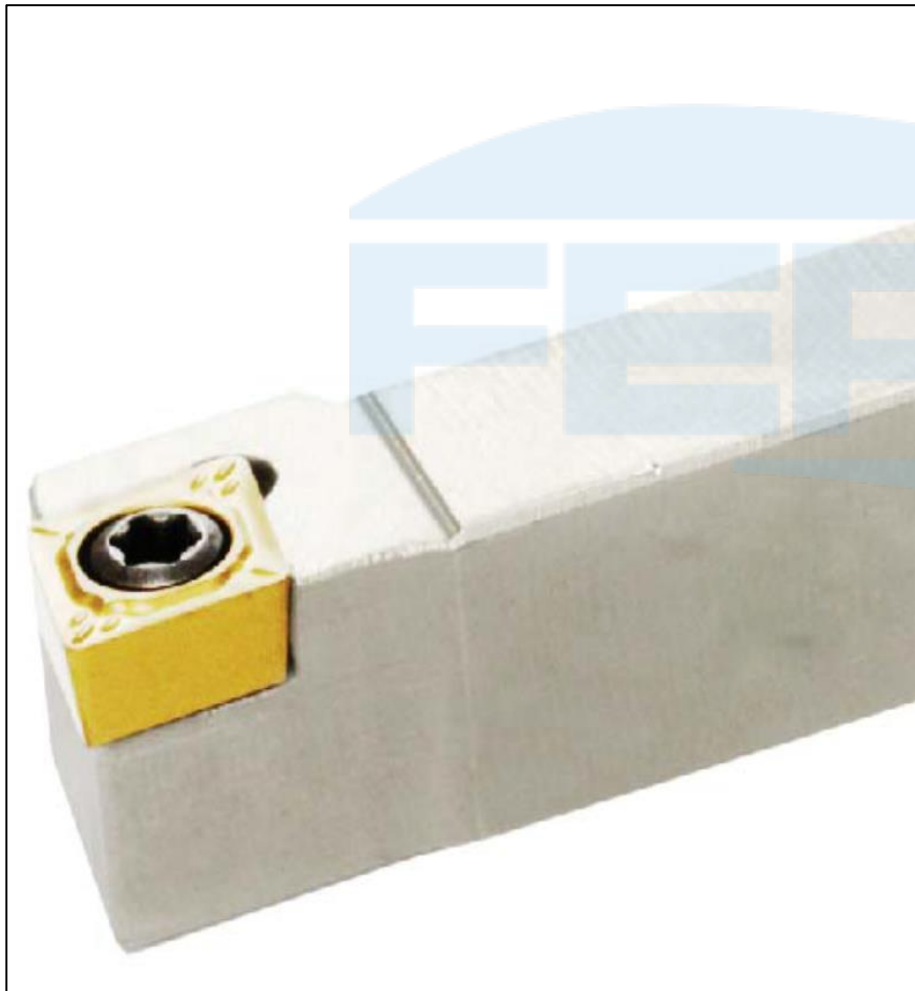
SISTEMA DE FIXAÇÃO POR PARAFUSO TORX

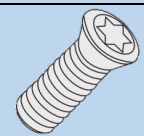
SCBCR

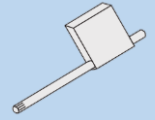
Suporte para torneiar 75° com pastilha positiva 80° para aproveitamento do ângulo de 100°







Ilustração na versão direita

Produtos	Dimensões (mm)				Pastilha 	Acessórios			
	h	b	l	f		 Parafuso Torx	 Calço	 Parafuso do Calço	 Chave Torx/Allen
SCBCR/L 2020 K09	20	20	125	17	CC_09T3	5513 020-01	5322 232-01	5512 090-01	T15-B
SCBCR/L 2525 M09	25	25	150	22					
SCBCR/L 2020 K12	20	20	125	17	CC_1204	5513 020-18	5322 232-02	5512 090-03	T15-B
SCBCR/L 2525 M12	25	25	150	22					

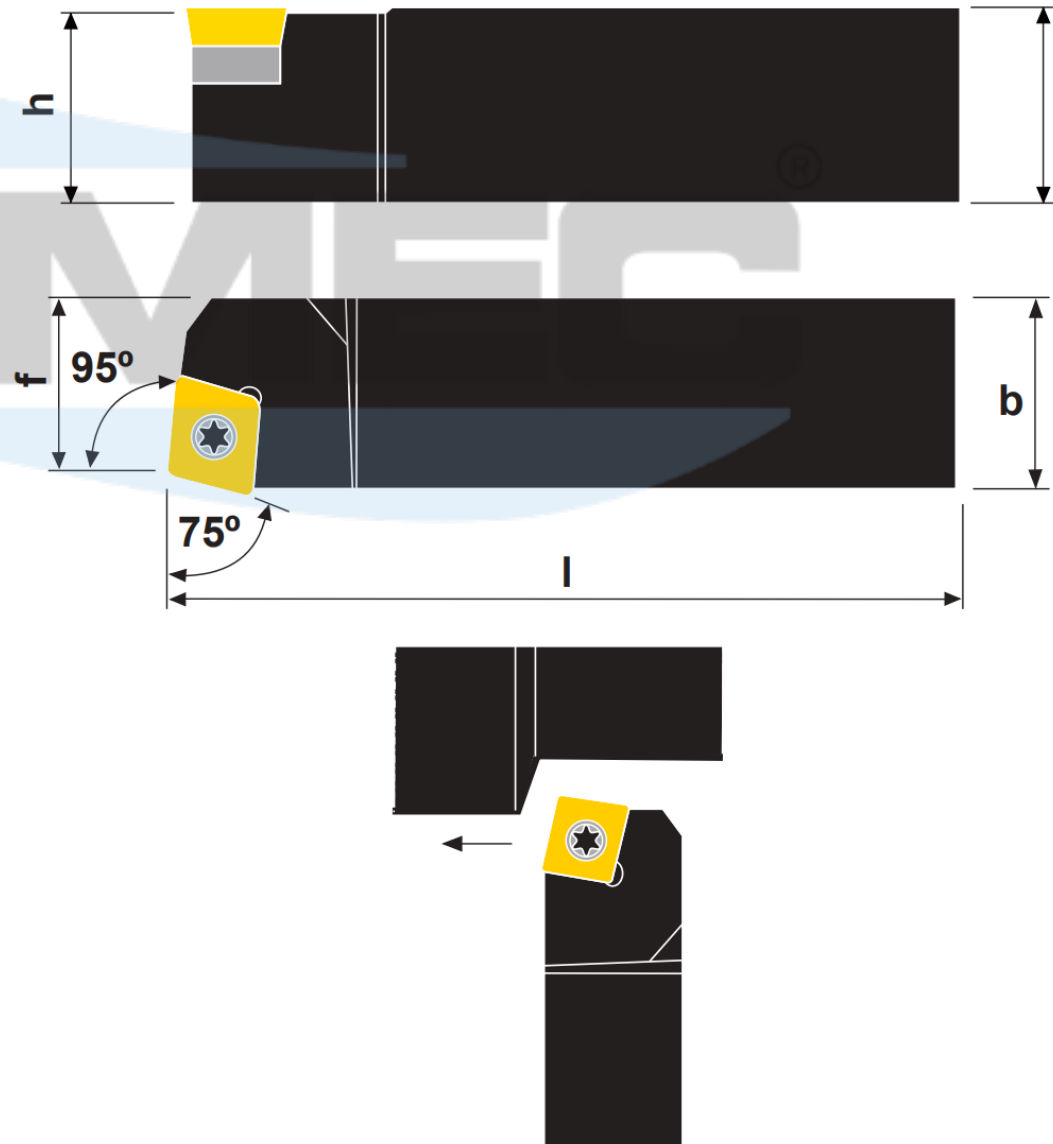
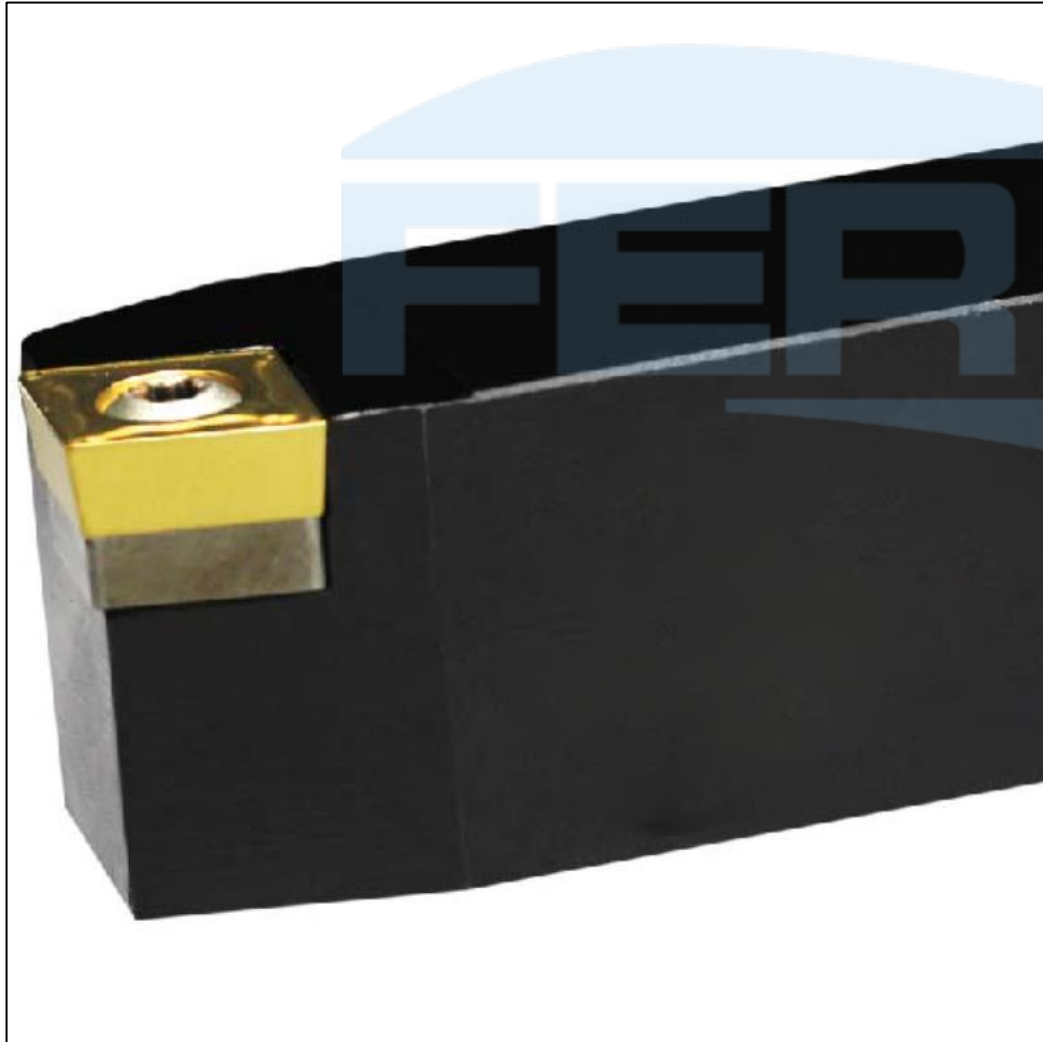
SISTEMA DE FIXAÇÃO POR PARAFUSO TORX

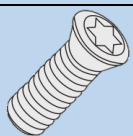
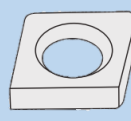
SCKCR

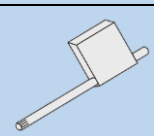
Suporte para facear a 75° com pastilha negativa 80° para aproveitamento do ângulo de 100°







Ilustração na versão direita

Produtos	Dimensões (mm)				Pastilha 	Acessórios			
	h	b	l	f		 Parafuso Torx	 Calço	 Parafuso do Calço	 Chave Torx/Allen
SCKCR/L 2020 K09	20	20	125	17	CC_09T3	5513 020-01	5322 232-01	5512 090-01	T15-B C-9/64
SCKCR/L 2525 M09	25	25	150	22					
SCKCR/L 2020 K12	20	20	125	17	CC_1204	5513 020-18	5322 232-02	5512 090-03	T15-B C-9/64
SCKCR/L 2525 M12	25	25	150	22					

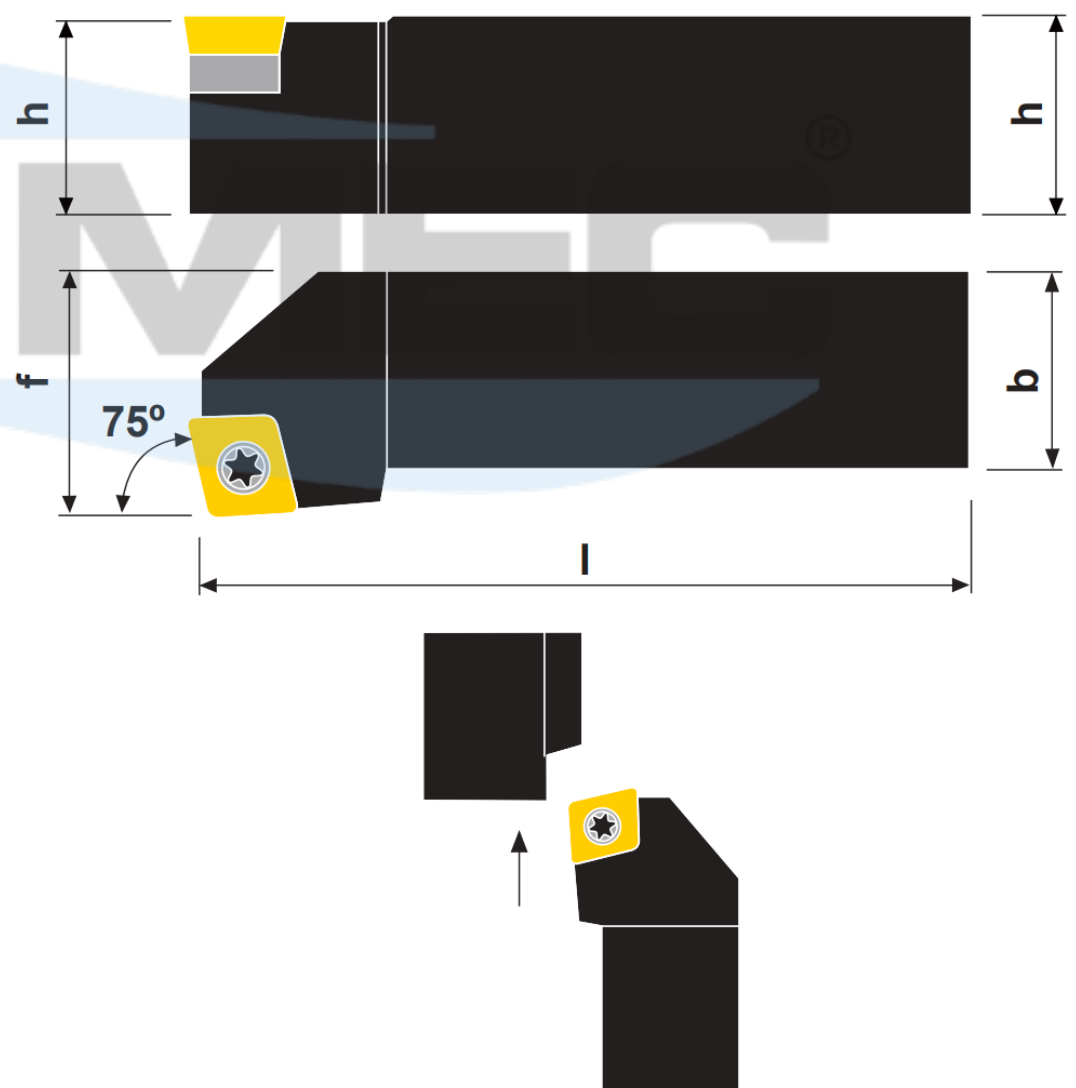
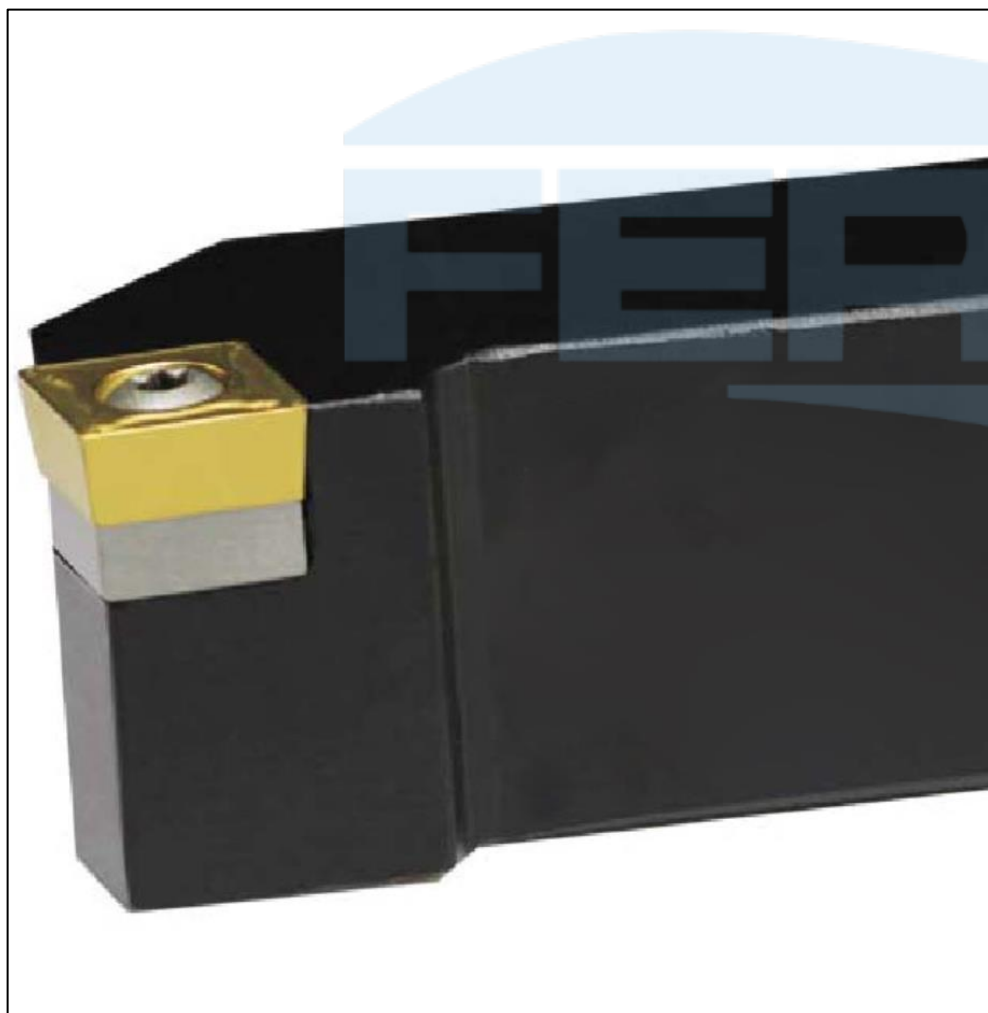
SISTEMA DE FIXAÇÃO POR PARAFUSO TORX

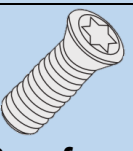
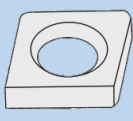
SCLCR

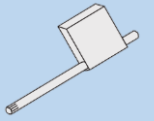
Suporte para torneiar 75° com pastilha positiva 80° para aproveitamento do ângulo de 100°







Ilustração na versão direita

Produtos	Dimensões (mm)				Pastilha 	Acessórios			
	h	b	l	f		 Parafuso Torx	 Calço	 Parafuso do Calço	 Chave Torx/Allen
SCLCR/L 0808 D06	8	8	60	10	CC_0602	5513 020-03	-	-	T7-B
SCLCR/L 1010 E06	10	10	70	12		5513 020-10	-	-	T15-B
SCLCR/L 1212 F09	12	12	80	16	CC_09T3	5513 020-01	5322 232-01	5512 090-01	T15-B C-9/64
SCLCR/L 1616 H09	16	16	100	20		5513 020-18	5322 232-02	5512 090-03	T15-B C-9/64
SCLCR/L 2020 K09	20	20	125	25		5513 020-18	5322 232-02	5512 090-03	T15-B C-9/64
SCLCR/L 2525 M09	25	25	150	32	CC_1204	5513 020-18	5322 232-02	5512 090-03	T15-B C-9/64
SCLCR/L 2020 K12	20	20	125	25		5513 020-18	5322 232-02	5512 090-03	T15-B C-9/64
SCLCR/L 2525 M12	25	25	150	32	5513 020-18	5322 232-02	5512 090-03	T15-B C-9/64	

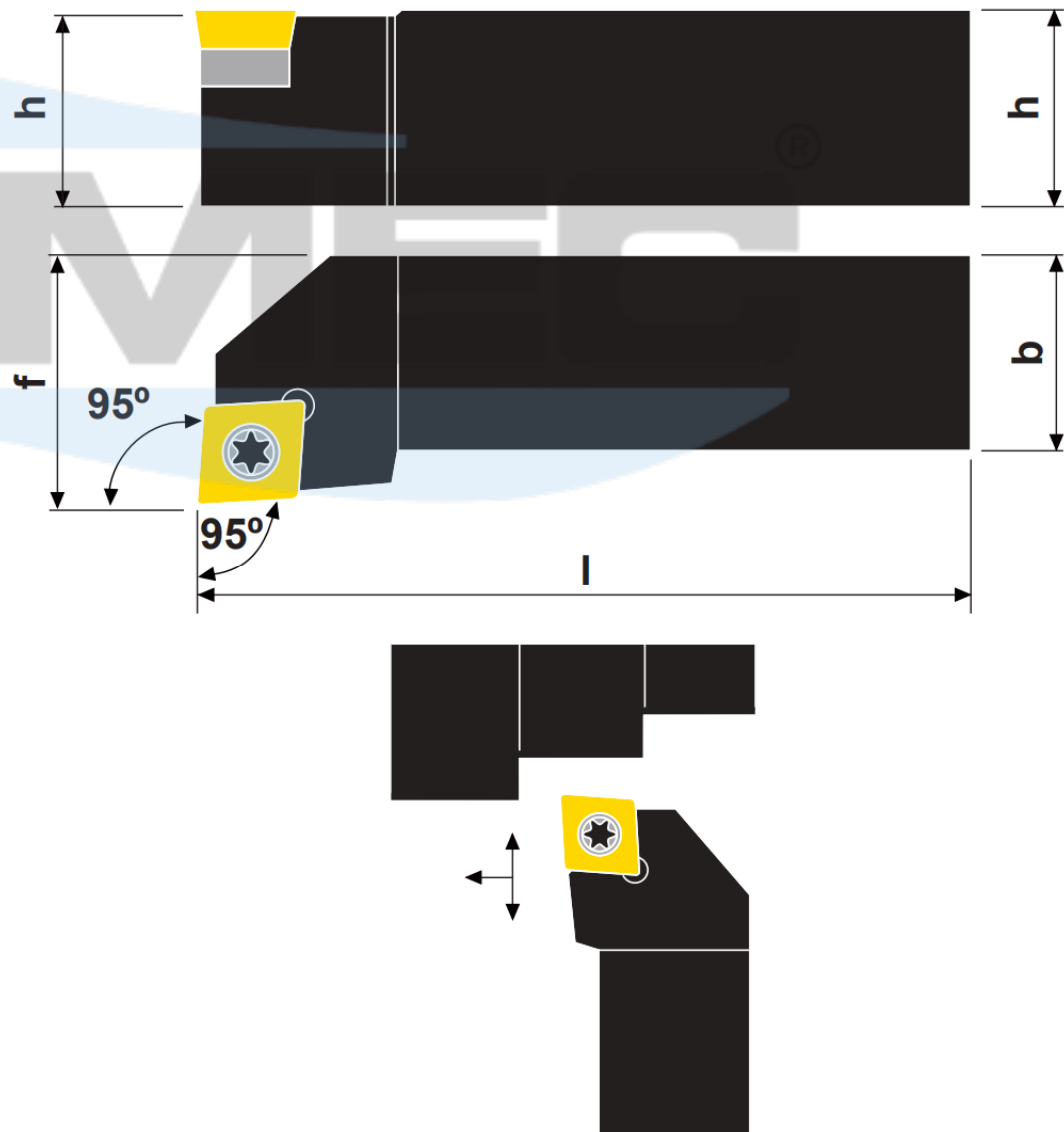
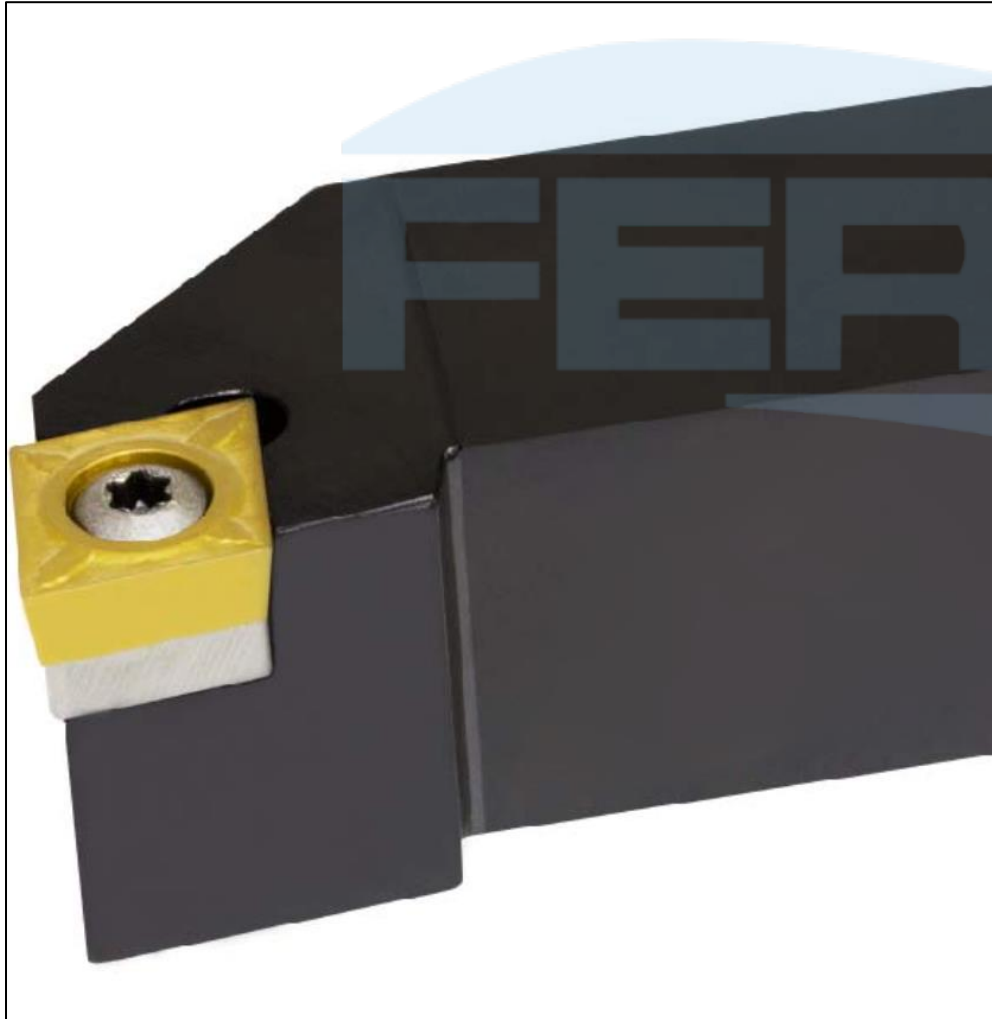

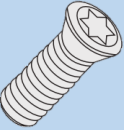
SISTEMA DE FIXAÇÃO POR PARAFUSO TORX

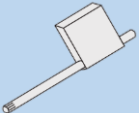
SCSCR

Suporte para torneiar e facear 45° com pastilha positiva 80°

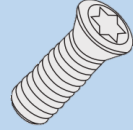
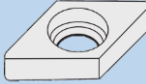

Ilustração na versão direita

Produtos	Dimensões (mm)				Pastilha 	Acessórios			
	h	b	l	f		 Parafuso Torx	 Calço	 Parafuso do Calço	 Chave Torx
SCSCR/L 1616 H12	16	16	100	20	CC_1204	5513 020-18	5322 232-02	5512 090-03	T15-B C - 9/64
SCSCR/L 2020 K12	20	20	125	25					
SCSCR/L 2525 M12	25	25	150	32					

SISTEMA DE FIXAÇÃO POR PARAFUSO TORX

SDACR

Suporte para torneiar e facear 90° com pastilha positiva 55°







Ilustração na versão direita

Produtos	Dimensões (mm)				Pastilha 	Acessórios			
	h	b	l	f		 Parafuso Torx	 Calço	 Parafuso do Calço	 Chave Torx
SDACR/L 1010 M07	10	10	150	10	DC_0702	5513 020-03	-	-	T7-B
SDACR/L 1212 M07	12	12	150	12		5513 020-10	-	-	T15-B
SDACR/L 1212 M11	12	12	150	12	DC_11T3	5513 020-01	5322 263-01	5512 090-01	T15-B
SDACR/L 1616 M11	16	16	150	16					C - 9/64
SDACR/L 2020 M11	20	20	150	20					

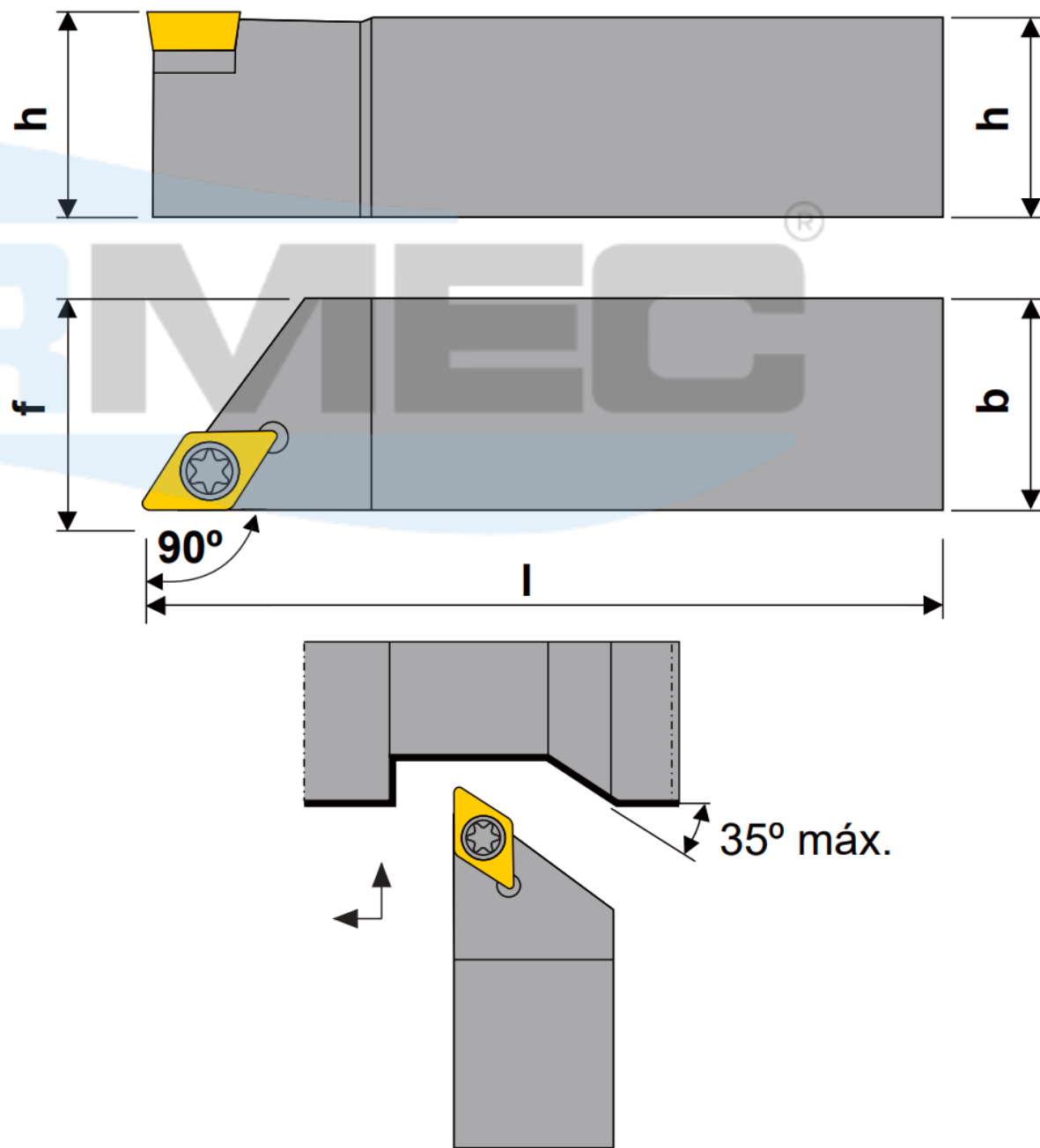
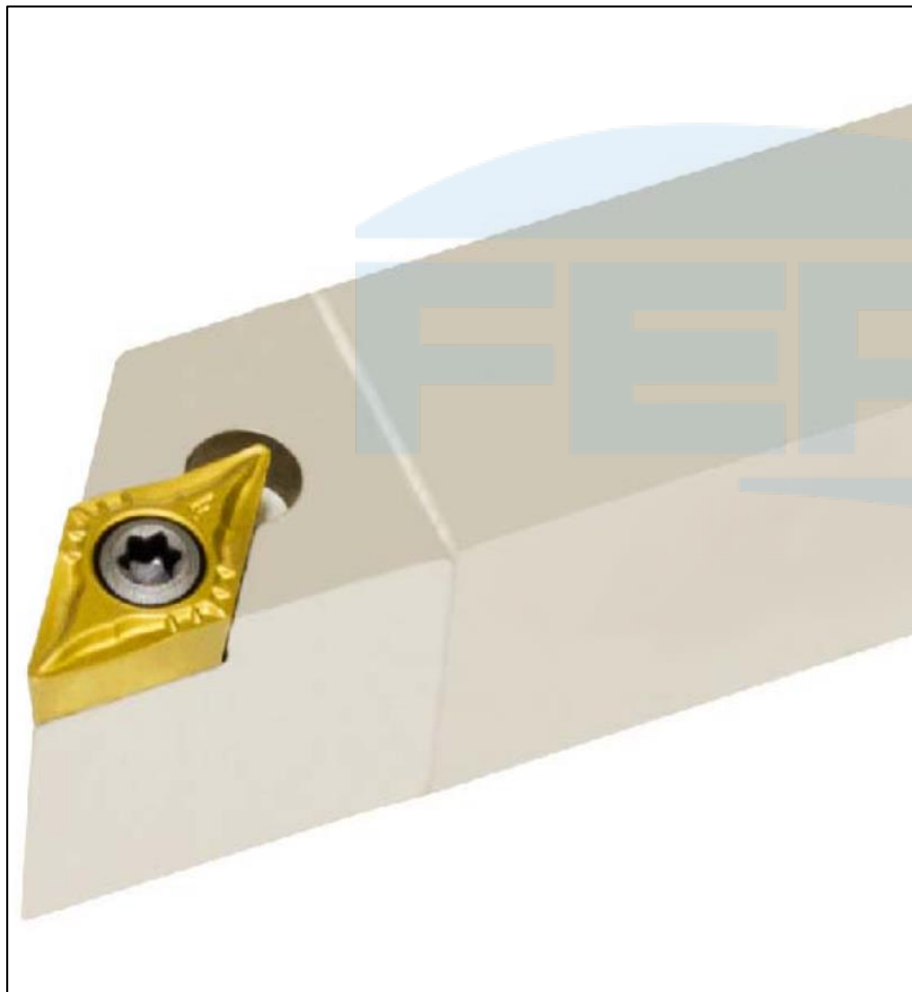
SISTEMA DE FIXAÇÃO POR PARAFUSO TORX

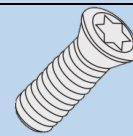
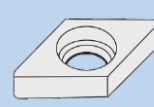
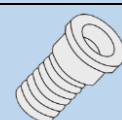
SDHCR

Suporte para torneiar e facear $107^{\circ}30'$ com pastilha positiva 55°









Ilustração na versão direita

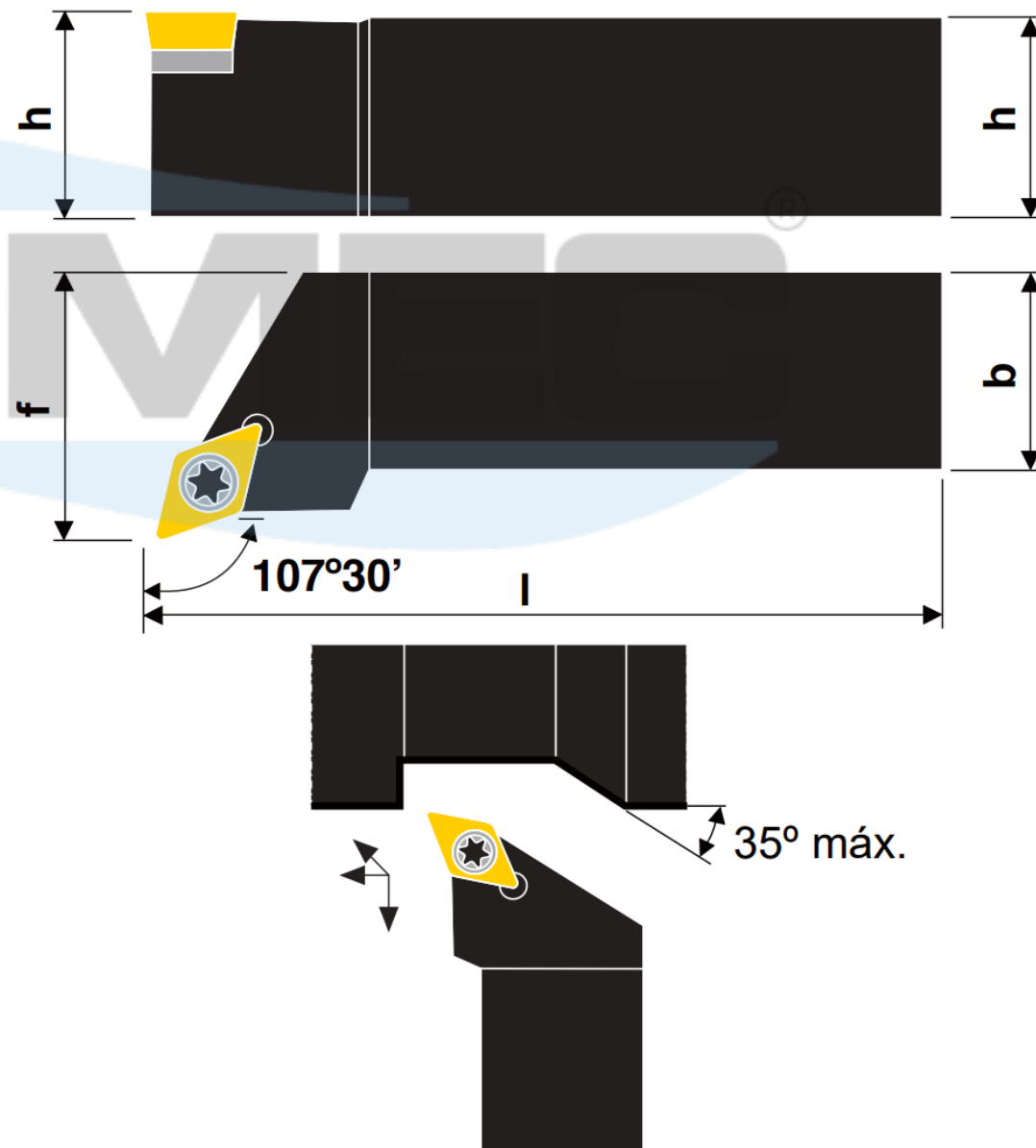

Produtos	Dimensões (mm)				Pastilha 	Acessórios			
	h	b	l	f		 Parafuso Torx	 Calço	 Parafuso do Calço	 Chave Torx
SDHCR/L 2020 K11	20	20	125	25	DC_11T3	5513 020-01	5322 263-01	5512 090-01	T15-B C - 9/64
SDHCR/L 2525 M11	25	25	150	32					

SISTEMA DE FIXAÇÃO POR PARAFUSO TORX

SDJCR

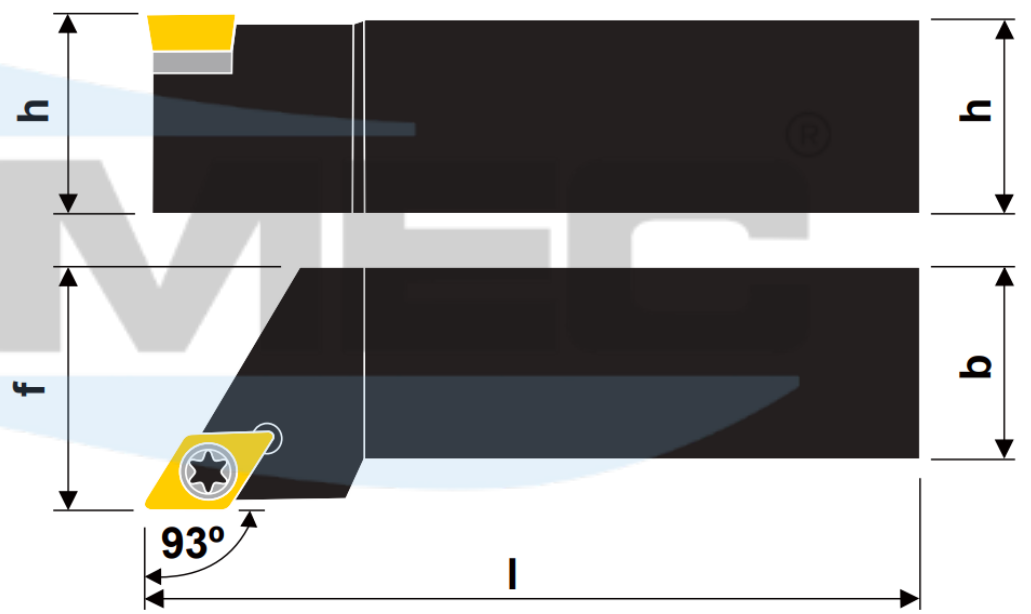
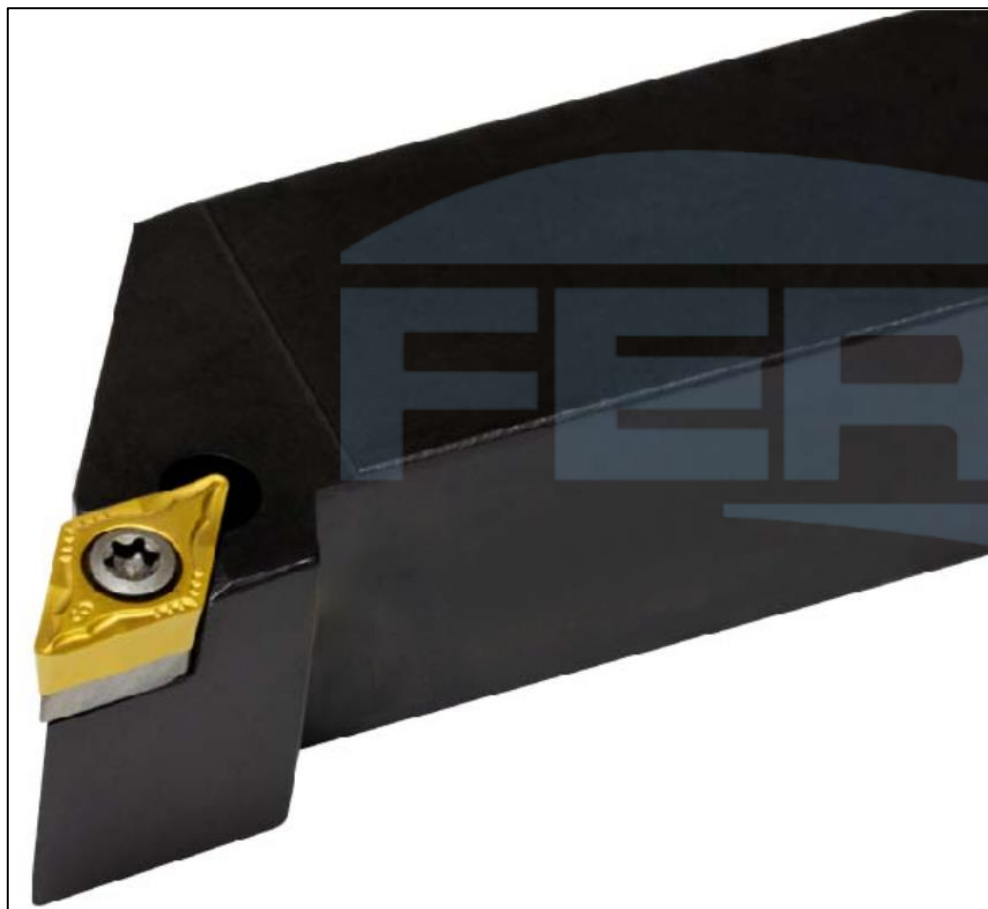
Suporte para torneiar e facear 93° com pastilha positiva 55°

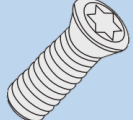
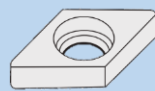

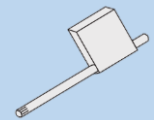
Produtos	Dimensões (mm)				Pastilha 	Acessórios			
	h	b	l	f		 Parafuso Torx	 Calço	 Parafuso do Calço	 Chave Torx/Allen
SDJCR/L 0808 F07	08	08	80	10	DC_0702	5513 020-03	-	-	T7-B
SDJCR/L 1010 E07	10	10	70	12					
SDJCR/L 1212 F07	12	12	80	16					
SDJCR/L 1616 H07	16	16	100	20					
SDJCR/L 2020 K07	20	20	125	25					
SDJCR/L 0808 K07-S	08	08	125	08					
SDJCR/L 1010 K07-S	10	10	125	10					
SDJCR/L 1212 K07-S	12	12	125	12					
SDJCR/L 1616 K07-S	16	16	125	16					
SDJCR/L 1212 F11	12	12	80	16	DC_11T3	5513 020-10	-	-	T15-B
SDJCR/L 1616 H11	16	16	100	20		5513 020-01	5322 263-01	5512 090-01	T15-B C - 9/64
SDJCR/L 2020 K11	20	20	125	25					
SDJCR/L 2525 M11	25	25	150	32					
SDJCR/L 1212 K11-S	12	12	125	12					
SDJCR/L 1616 K11-S	16	16	125	16					

SISTEMA DE FIXAÇÃO POR PARAFUSO TORX

SDNCN

Suporte neutro para torneiar com pastilha positiva 55°







Ilustração na versão direita

Produtos	Dimensões (mm)				Pastilha 	Acessórios			
	h	b	l	f		 Parafuso Torx	 Calço	 Parafuso do Calço	 Chave Torx
SDNCN 1010 E07	10	10	70	5,2	DC_0702	5513 020-03	-	-	T07-B
SDNCN 1212 F07	12	12	80	6,2					
SDNCN 1616 H07	16	16	100	8,5					
SDNCN 2020 K07	20	20	125	10,5					
SDNCN 1212 F11	12	12	80	6,2	DC_11T3	5513 020-01	5322 263-01	5512 090-01	T15-B C-9/64
SDNCN 1616 H11	16	16	100	8,5					
SDNCN 2020 K11	20	20	125	10,5					
SDNCN 2525 M11	25	25	150	13					

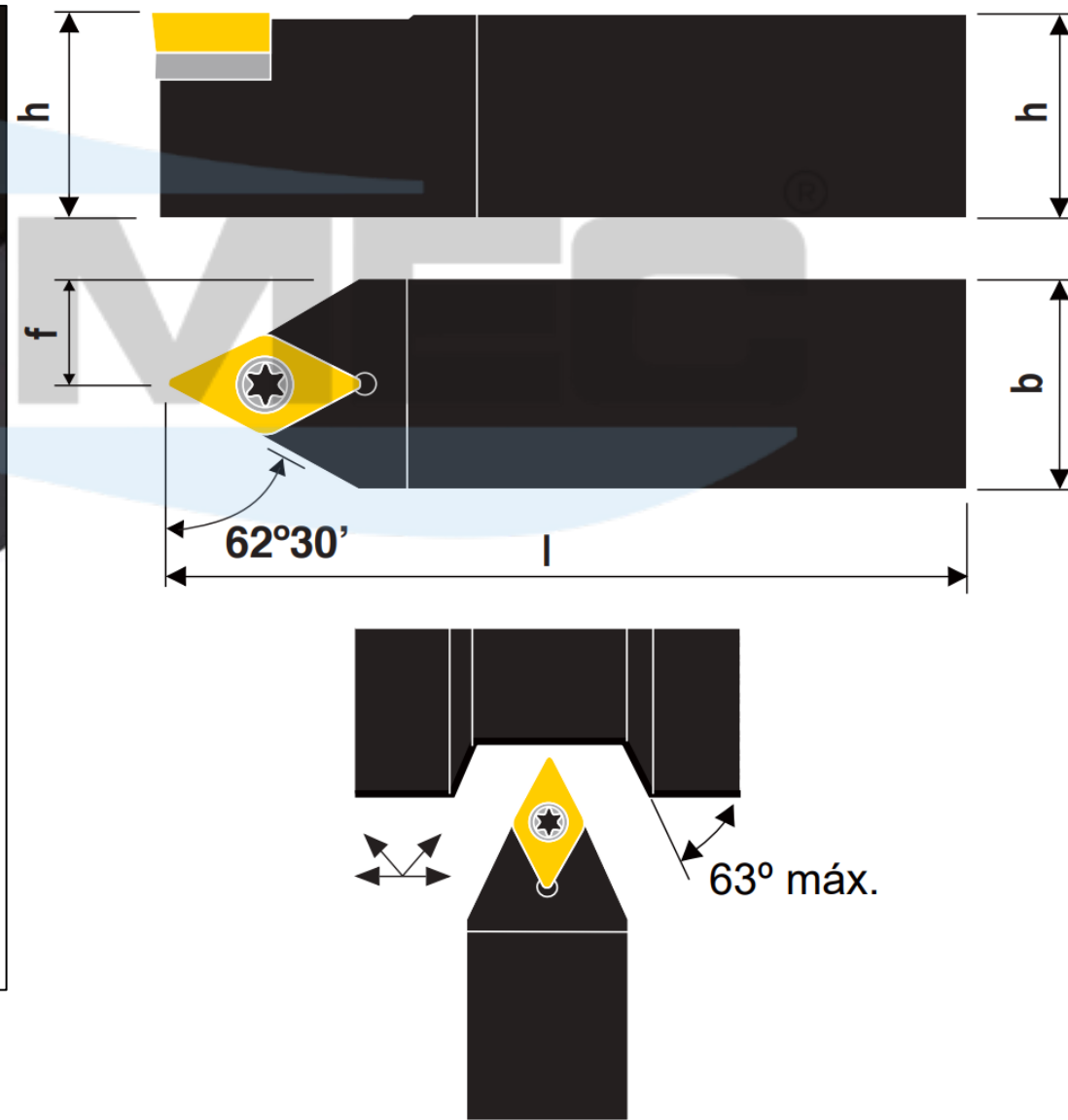
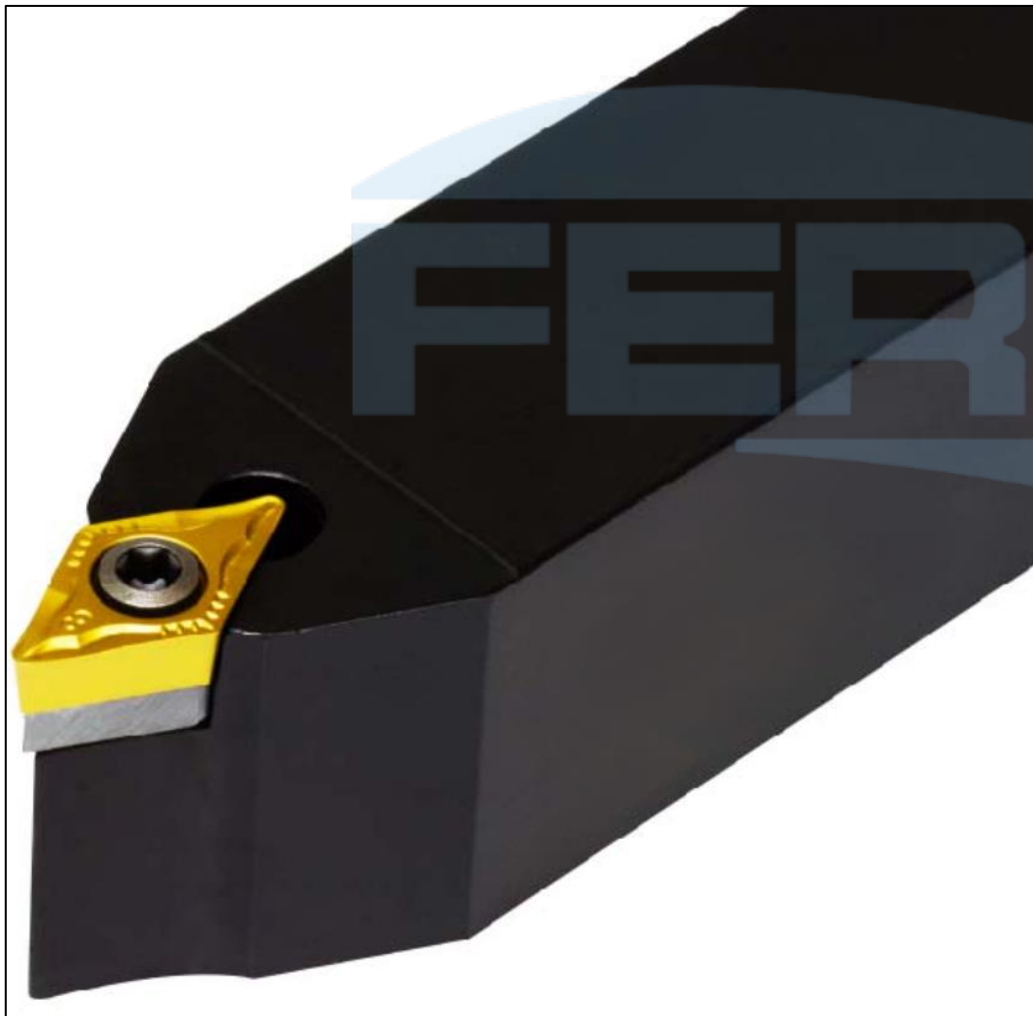
SISTEMA DE FIXAÇÃO POR PARAFUSO TORX

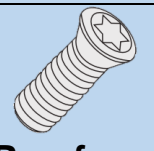
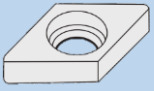
SRDCN

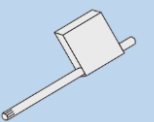
Suporte neutro para torneiar e facear com pastilha positiva redonda

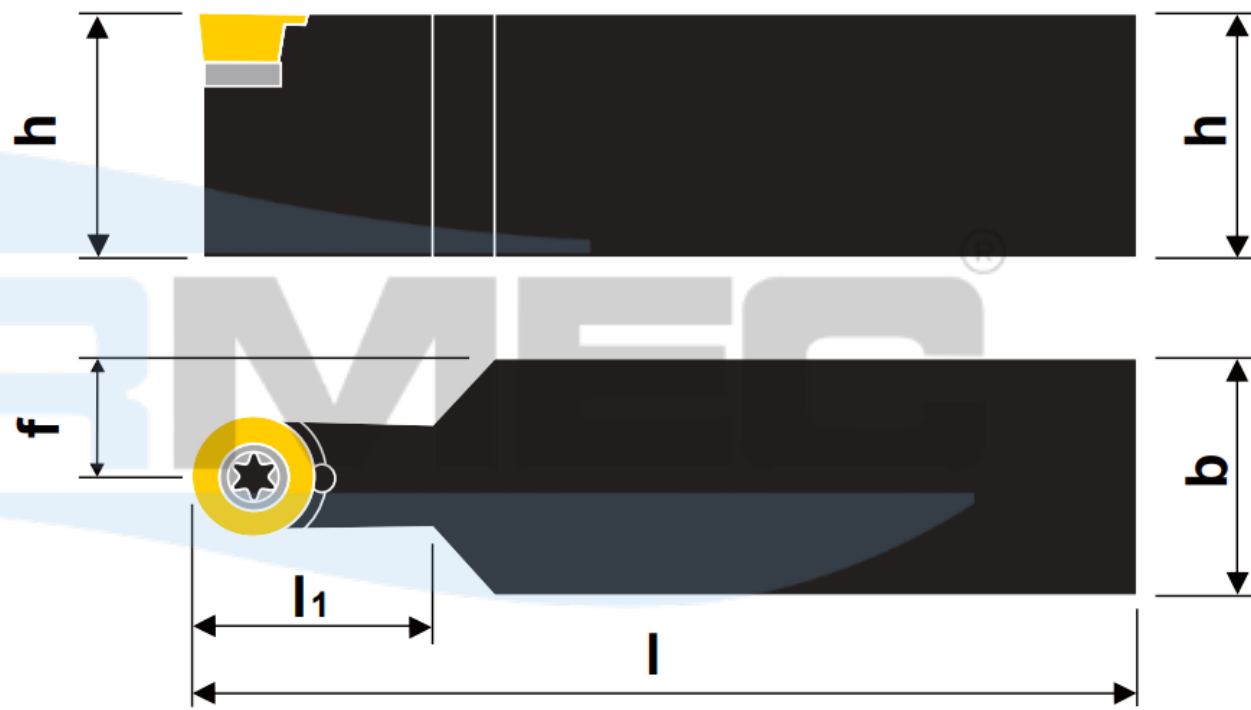

Produtos	Dimensões (mm)					Pastilha	Acessórios			
	h	b	l	l1	f		Parafuso Torx	Calço	Parafuso do Calço	Chave Torx/ Allen
SRDCN 1010 E05	10	10	70	10	7,5	RC_0502MO	5513 020-05	-	-	T7-B
SRDCN 2020 K05 - A	20	20	125	15	12,5					
SRDCN 1212 F06	12	12	80	12	9	RC_0602MO	5513 020-03	-	-	T7-B
SRDCN 2020 K06 - A	20	20	125	25	13					
SRDCN 2525 M06 - A	25	25	150	28	15,5					
SRDCN 1616 H08	16	16	100	16	12	RC_0803MO	5513 020-04	-	-	T9-B
SRDCN 2020 K08 - A	20	20	125	25	14					
SRDCN 2525 M08 - A	25	25	150	28	16,5					
SRDCN 2020 K10 - A	20	20	125	25	15	RC_10T3MO	5513 020-10	5322 110-01	5512 090-01	T15-B C - 9/64
SRDCN 2525 M10 - A	25	25	150	28	17,5					
SRDCN 2020 K12 - A	20	20	125	25	16	RC_1204MO	5513 020-01	5322 110-02	5512 090-01	T15-B C - 9/64
SRDCN 2525 M12 - A	25	25	150	28	18,5					
SRDCN 3225 P12 - A	32	25	170	28	18,5					
SRDCN 2525 M16 - A	25	25	150	35	20,5	RC_1606MO	5513 020-26	5322 110-03	5512 090-06	T20-B C - 5,0
SRDCN 3225 P16 - A	32	25	170	35	20,5					
SRDCN 3225 M20 - A	25	25	150	38	22,5	RC_2006MO	5513 020-14	5322 110-04	5512 090-08	T25-B C - 6,0
SRDCN 3232 P20 - A	32	32	170	40	26					

SISTEMA DE FIXAÇÃO POR PARAFUSO TORX

SRDCR

Suporte para torneiar e facear com pastilha positiva redonda

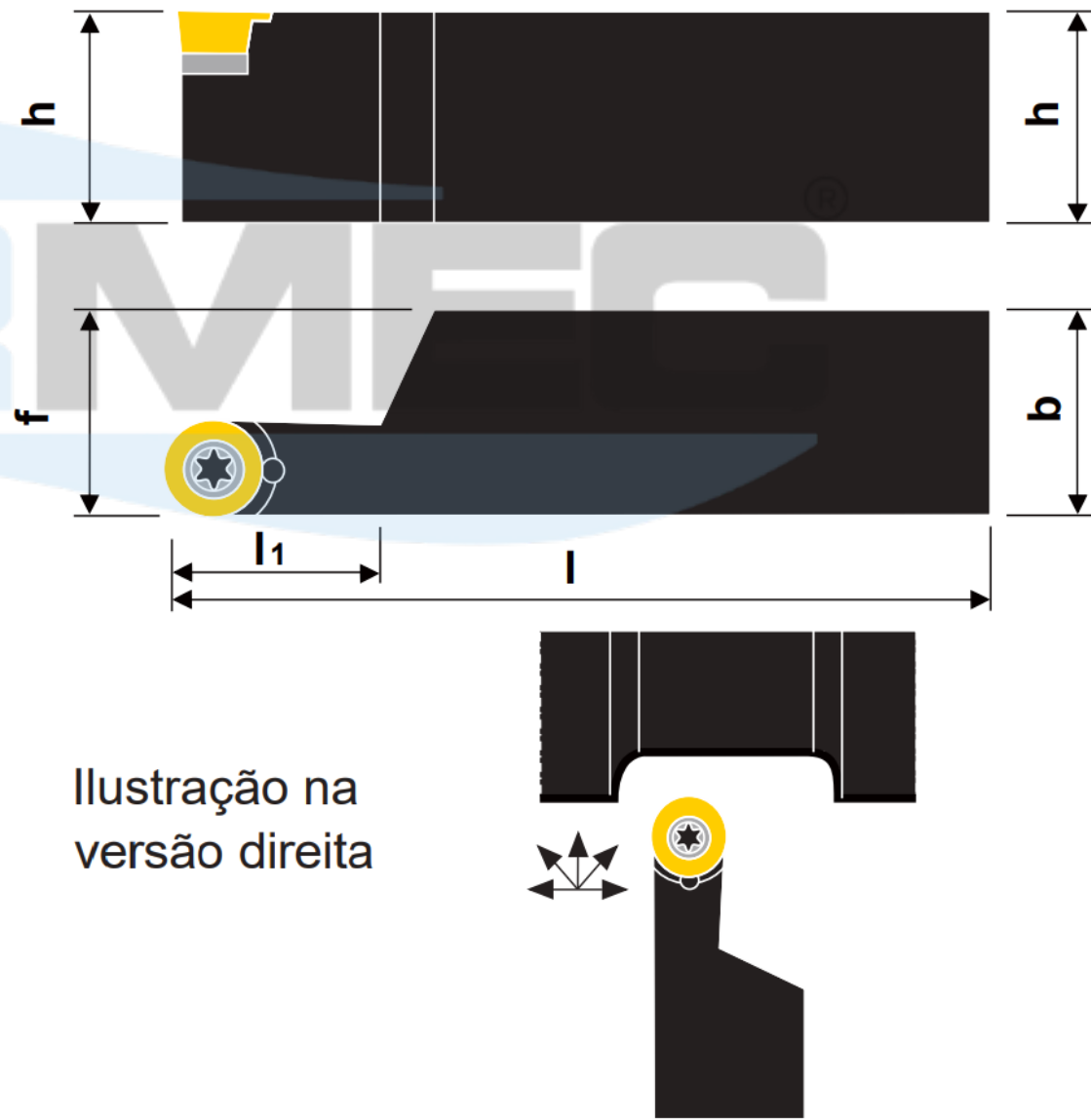
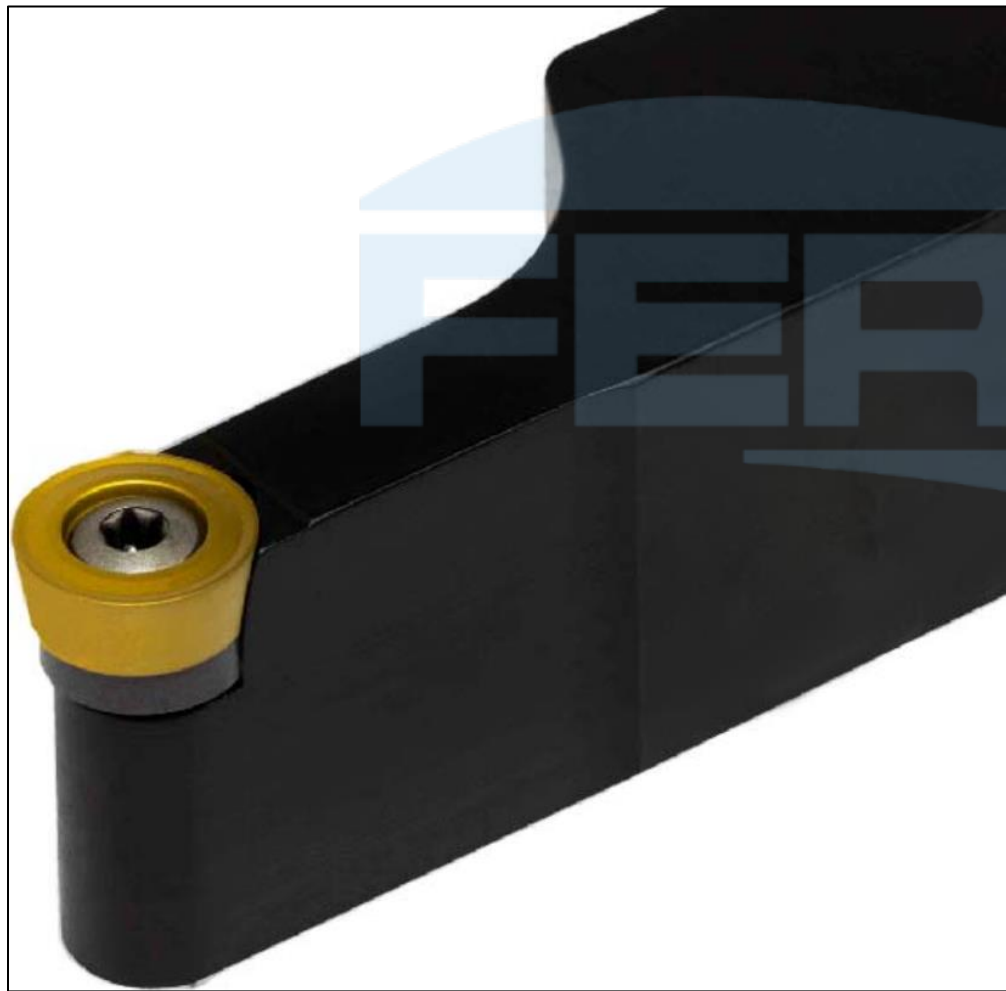

Produtos	Dimensões (mm)					Pastilha	Acessórios			
	h	b	l	l1	f		Parafuso Torx	Calço	Parafuso do Calço	Chave Torx/ Allen
SRDCR/L 2020 K06 - A	20	20	125	25	20,5	RC_0602MO	5513 020-03	-	-	T7-B
SRDCR/L 2525 M06 - A	25	25	150	28	25,5					
SRDCR/L 2020 K08 - A	20	20	125	25	20,5	RC_0803MO	5513 020-04	-	-	T9-B
SRDCR/L 2525 M08 - A	25	25	150	20	25,5					
SRDCR/L 2020 K10 - A	20	20	125	25	20,5	RC_10T3MO	5513 020-10	5322 110-01	5512 090-01	T15-B C - 9/64
SRDCR/L 2525 M10 - A	25	25	150	28	25,5					
SRDCR/L 2020 K12 - A	20	20	125	25	20,5					
SRDCR/L 2525 K12 - A	25	25	150	28	20,5	RC_1204MO	5513 020-01	5322 110-02	5512 090-01	T15-B C - 9/64
SRDCR/L 3225 P12 - A	32	25	170	28	25,5					
SRDCR/L 3225 P16 - A	32	25	170	35	25,5	RC_1206MO	5513 020-26	5322 110-03	5512 090-06	T20-B/ C-5
SRDCR/L 3232 P20 - A	32	32	170	40	32,5	RC_2006MO	5513 020-14	5322 110-04	5512 090-08	T20-B/ C-5

SISTEMA DE FIXAÇÃO POR PARAFUSO TORX

SRSCR

Suporte para torneiar e facear com pastilha positiva redonda



Ilustração na versão direita

Produtos	Dimensões (mm)				Pastilha	Acessórios			
	h	b	l	f		Parafuso Torx	Calço	Parafuso do Calço	Chave Torx/ Allen
SRSCR/L 2020 K10 - A	20	20	125	25	RC_10T3MO	5513 020-10	5322 110-01	5512 090-01	T15-B C - 9/64
SRSCR/L 2525 M10 - A	25	25	150	32					
SRSCR/L 2020 K12 - A	20	20	125	25	RC_1204MO	5513 020-01	5322 110-02	5512 090-01	T15-B C - 9/64
SRSCR/L 2525 M12 - A	25	25	150	32					
SRSCR/L 3225 P12 - A	32	25	170	32					
SRSCR/L 3225 P16 - A	32	25	170	32	RC_1606MO	5513 020-26	5322 110-03	5512 090-06	T20-B / C-5,0
SRSCR/L 3232 P20 - A	32	32	170	40	RC_2006MO	5513 020-14	5322 110-04	5512 090-08	T25-F / C-6,0

SISTEMA DE FIXAÇÃO POR PARAFUSO TORX

SSDCN

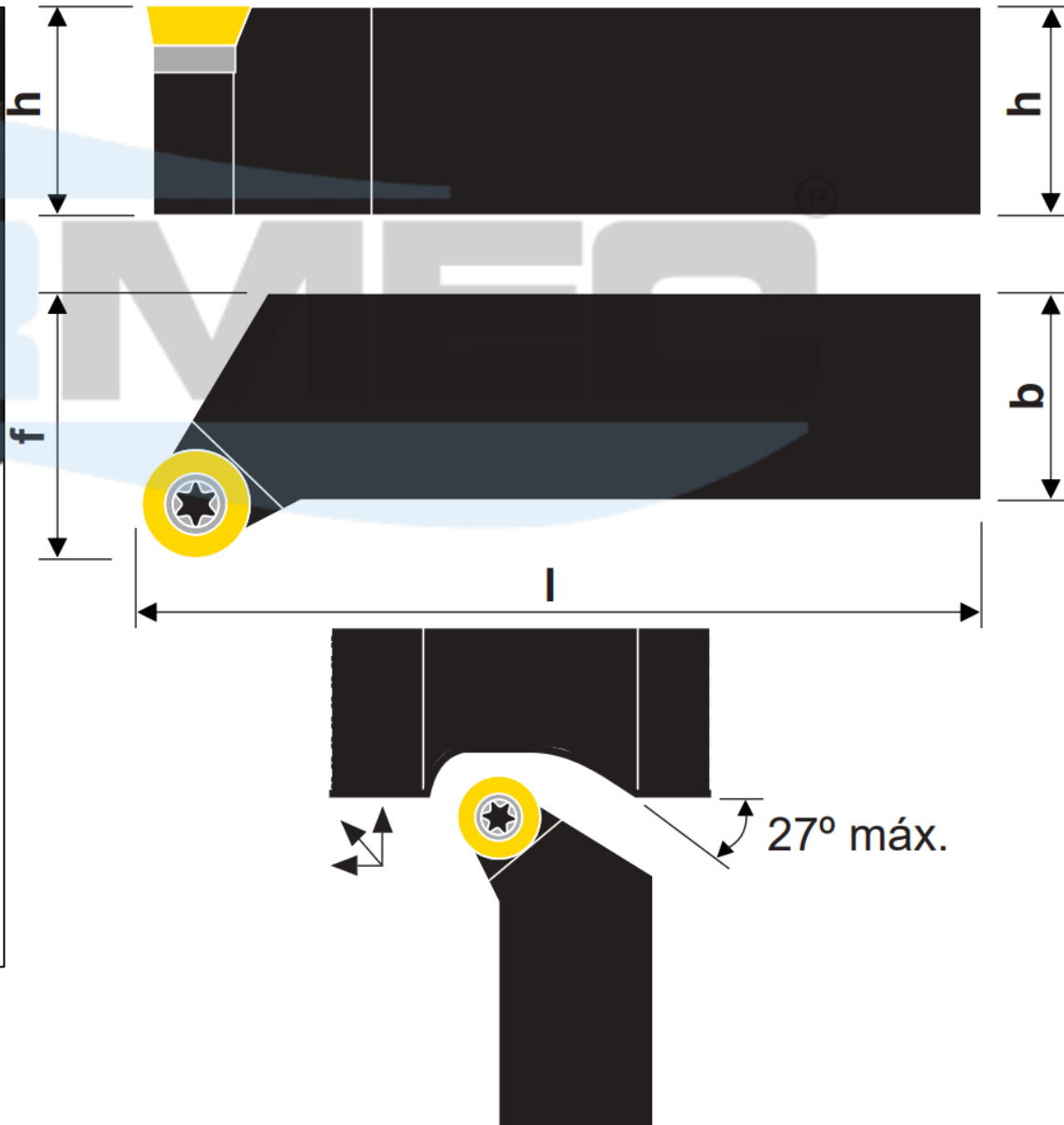
Suporte neutro para torneiar com pastilha positiva quadrada



Ilustração na versão direita

Produtos	Dimensões (mm)				Pastilha	Acessórios			
	h	b	l	f		Parafuso Torx	Calço	Parafuso do Calço	Chave Torx/ Allen
SSDCN 1212 F09	12	12	80	6	SC_09T3	5513 020-10	-	-	T15-B
SSDCN 1616 H09	16	16	100	8		5513 020-01	5322 420-01	5512 090-01	T15-B C - 9/64
SSDCN 2020 K09	20	20	125	10		5513 020-18	5322 420-02	5512 090-03	T15-B C - 9/64
SSDCN 2020 K12	20	20	125	10	SC_1204				
SSDCN 2525 M12	25	25	150	12,5					

SISTEMA DE FIXAÇÃO POR PARAFUSO TORX

SSSCR

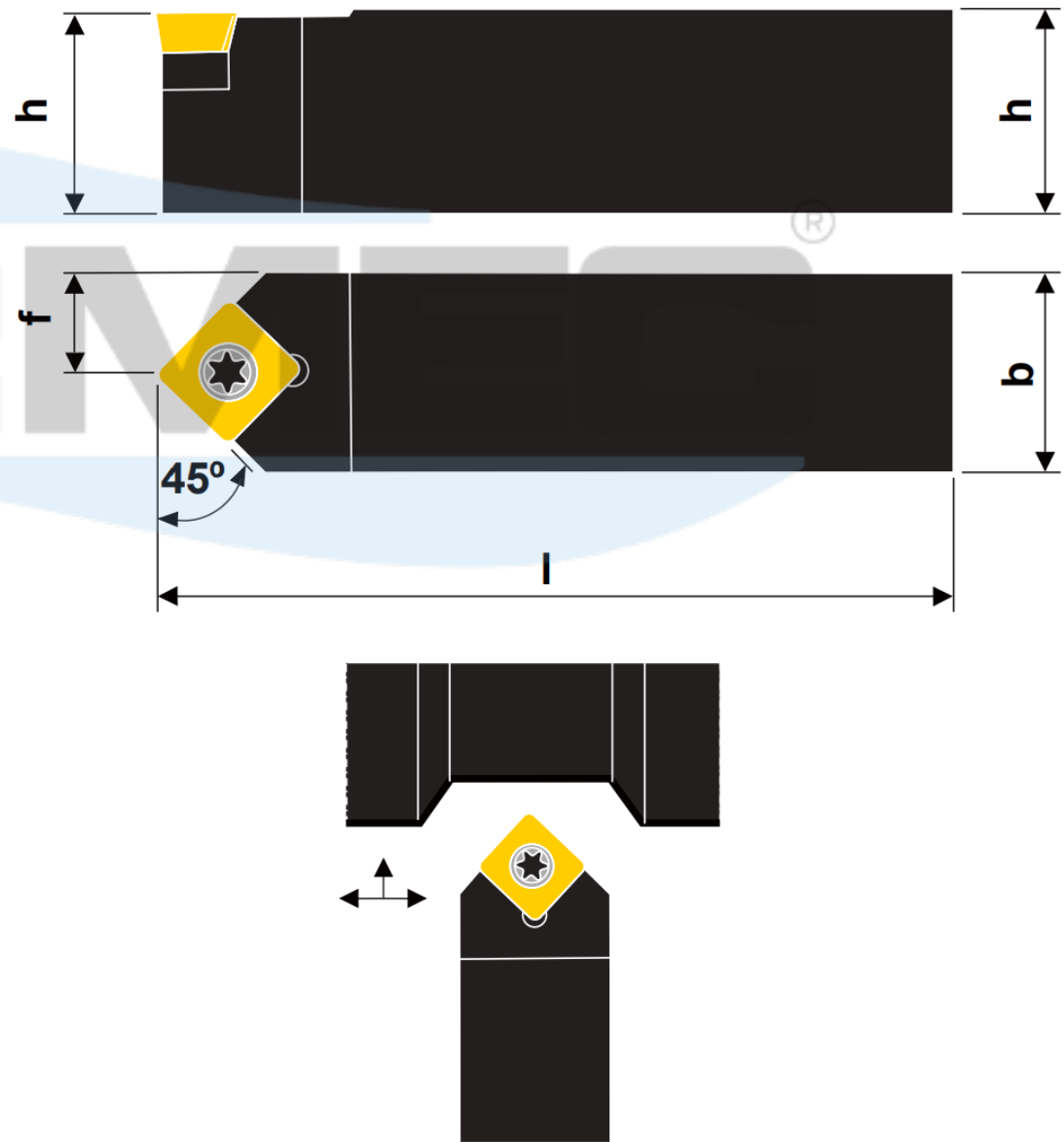
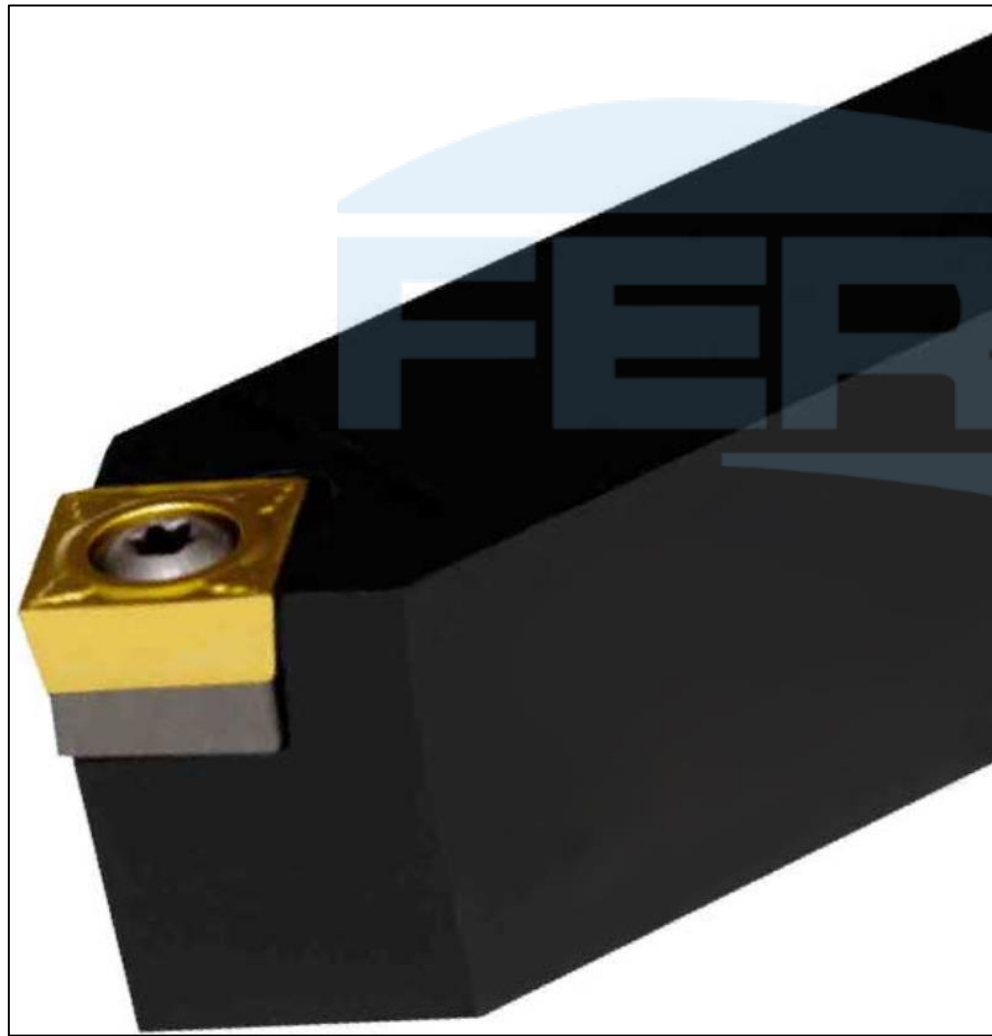
Suporte para torneiar e facear 45° com pastilha positiva quadrada



Ilustração na versão direita

Produtos	Dimensões (mm)				Pastilha	Acessórios			
	h	b	l	f		Parafuso Torx	Calço	Parafuso do Calço	Chave Torx/ Allen
SSSCR/L 1010 E09	10	10	60	12	SC_09T3	5513 020-10	-	-	T15-B
SSSCR/L 1212 F09	12	12	80	16					
SSSCR/L 1616 H09	16	16	100	20	SC_09T3	5513 020-10	5322 420-01	5512 090-01	T15-B
SSSCR/L 2020 K09	20	20	125	25					
SSSCR/L 2020 K12	20	20	125	25	SC_1204	5513 020-18	5322 420-02	5512 090-03	T15-B C - 9/64
SSSCR/L 2525 M12	25	25	150	27					

SISTEMA DE FIXAÇÃO POR PARAFUSO TORX

STDCR

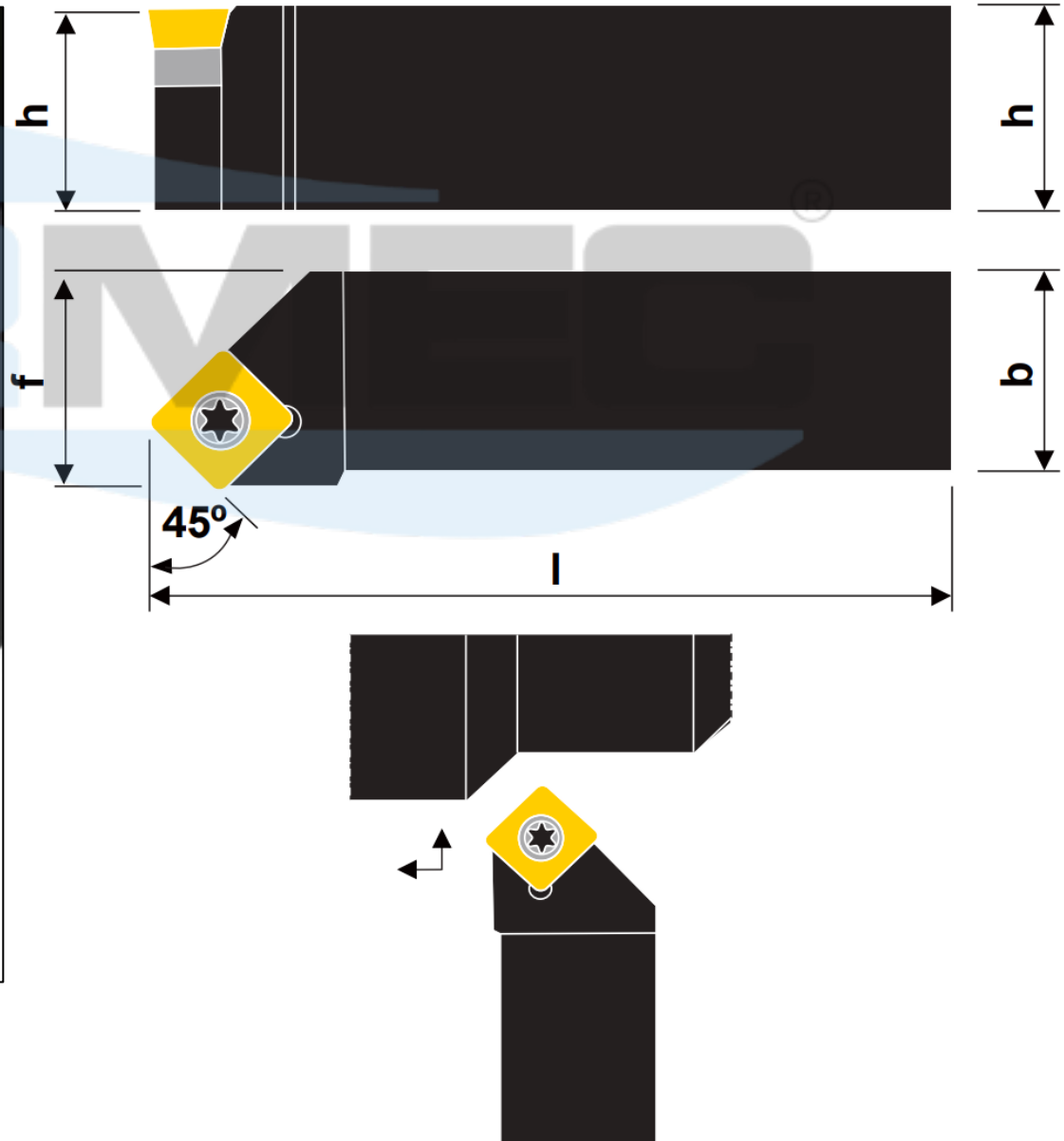
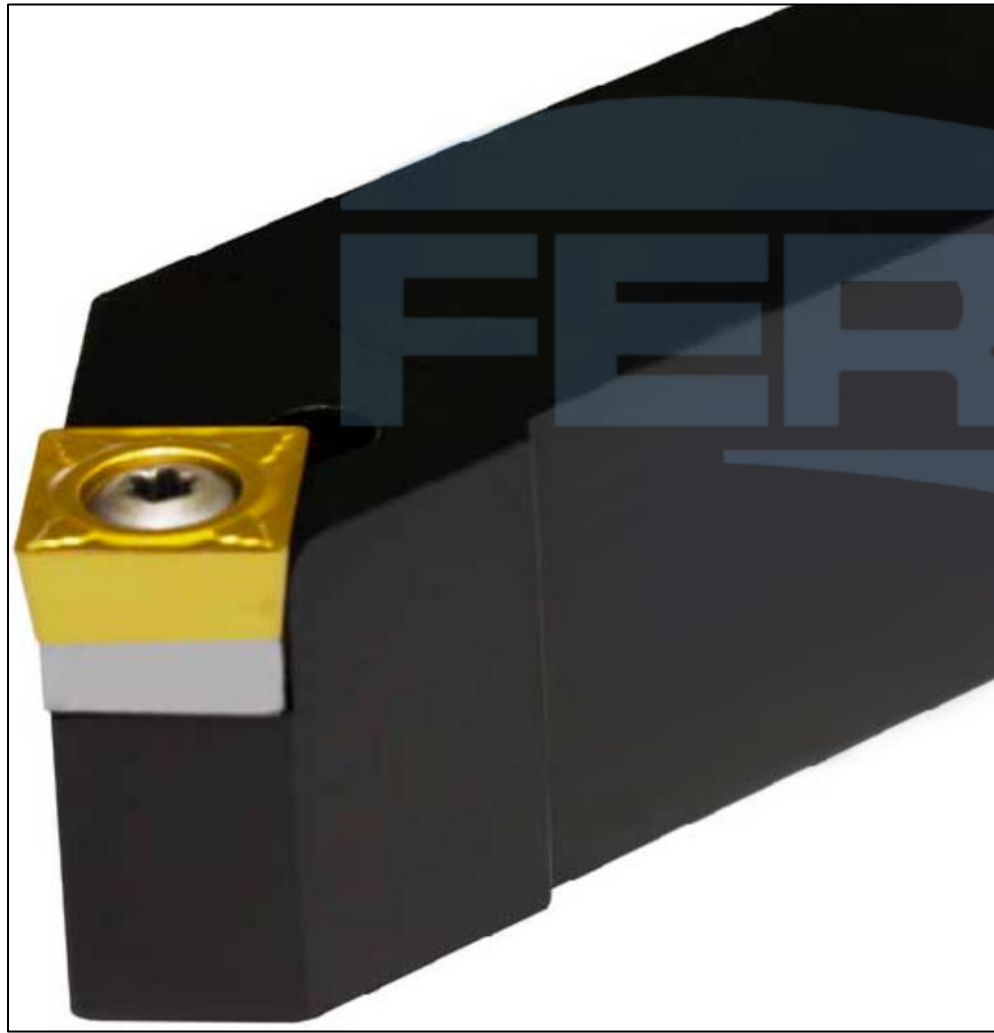
Suporte para torneiar e facear 45° com pastilha positiva triangular





Ilustração na versão direita

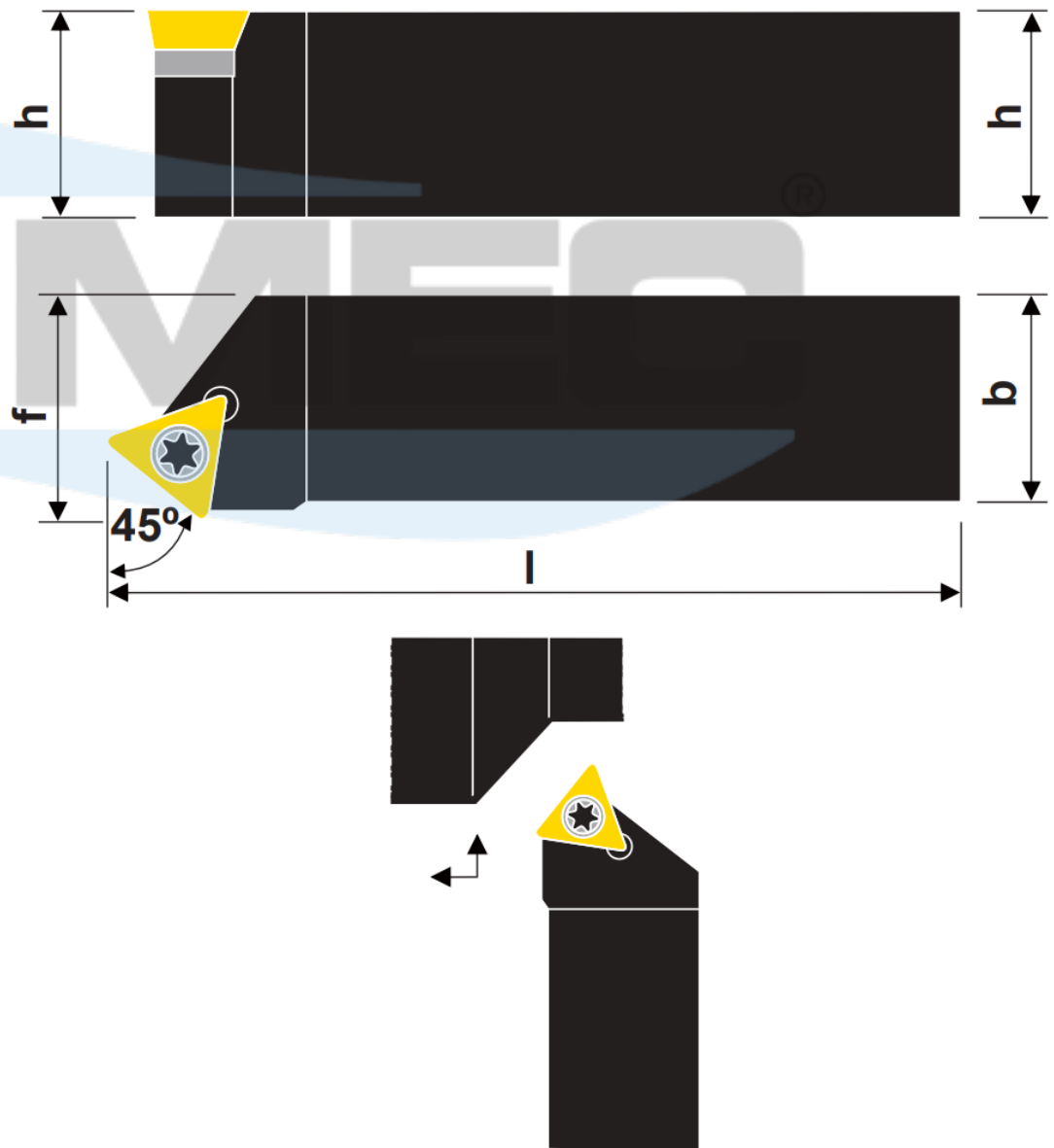
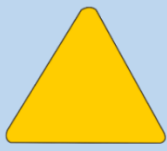
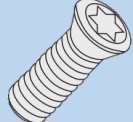
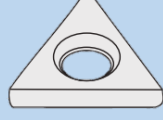

Produtos	Dimensões (mm)				Pastilha	Acessórios			
	h	b	l	f		 Parafuso Torx	 Calço	 Parafuso do Calço	 Chave Torx/ Allen
STDCR/L 1010 E09	10	10	70	11	TC_0902	5513 020-05	-	-	T7-B
STDCR/L 1212 F11	12	12	80	13	TC_1102	5513 020-03	-	-	T7-B
STDCR/L 1616 H11	16	16	100	17					
STDCR/L 1616 H16	16	16	100	17	TC_16T3	5513 020-01	5322 320-01	5512 090-01	T15-B C - 9/64
STDCR/L 2020 K16	20	20	125	22					
STDCR/L 2525 M16	25	25	150	27					

SISTEMA DE FIXAÇÃO POR PARAFUSO TORX

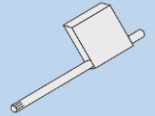
STFCR

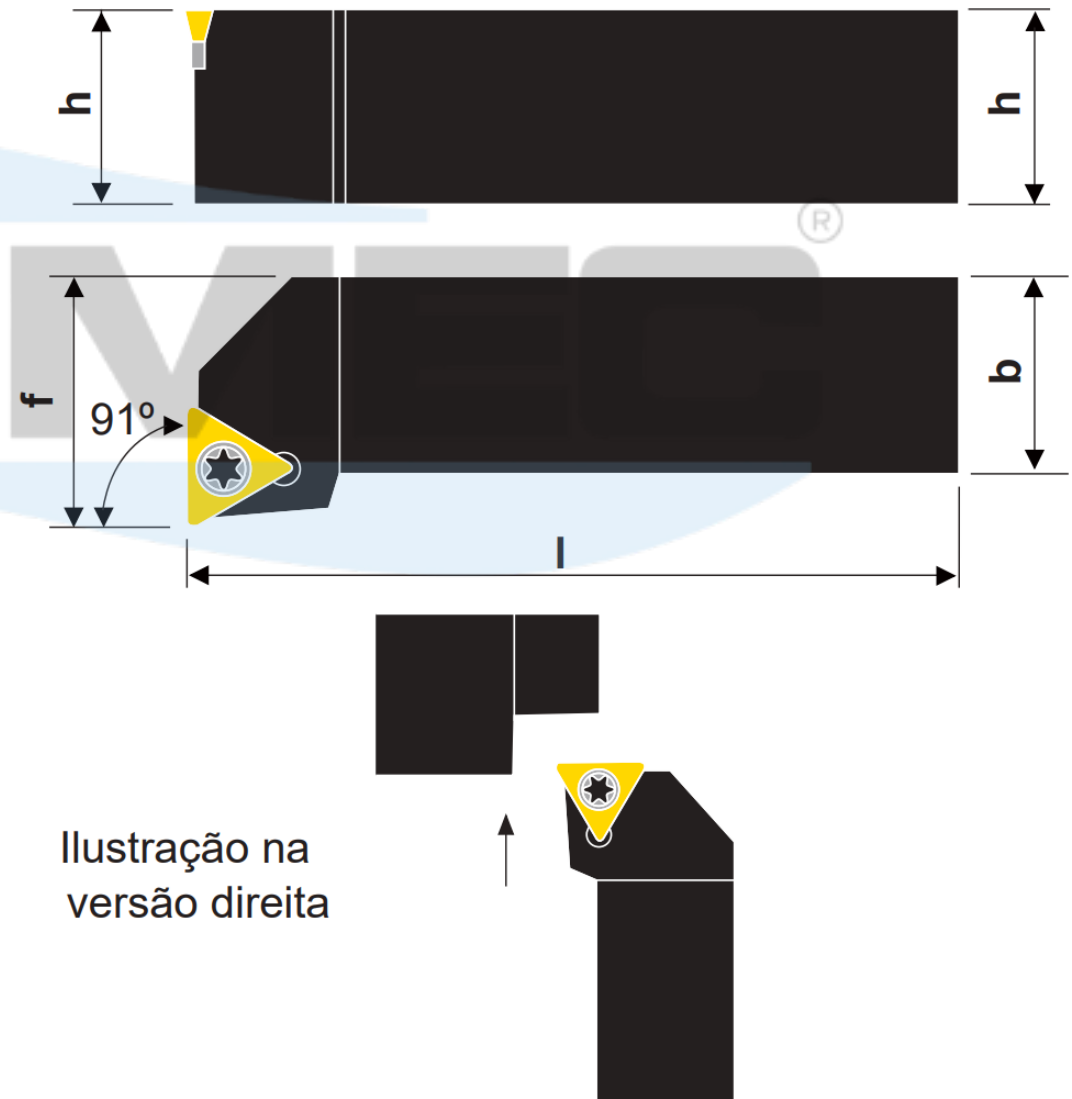
Suporte para facear 91° com pastilha positiva triangular

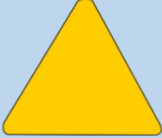
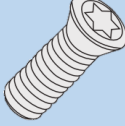
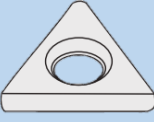

Produtos	Dimensões (mm)				Pastilha	Acessórios			
	h	b	l	f		 Parafuso Torx	 Calço	 Parafuso do Calço	 Chave Torx/Allen
STFCR/L 0808 E09	08	08	70	10	TC_0902	5513 020-05	-	-	T7-B
STFCR/L 1010 E09	10	10	70	12					
STFCR/L 1212 F11	12	12	80	16	TC_1102	5513 020-03	-	-	T7-B
STFCR/L 1616 H11	16	16	100	20					
STFCR/L 2020 K11	20	20	125	25					
STFCR/L 2020 K11 - A	20	20	125	20,8					
STFCR/L 2525 M11 - A	25	25	150	25,9	TC_16T3	5513 020-01	5322 320-01	5512 090-01	T15-B C - 9/64
STFCR/L 2020 K16	20	20	125	25					
STFCR/L 2525 M16	25	25	150	32					
STFCR/L 2525 M16 - A	25	25	150	25,9	TC_2204	5513 020-18	5322 320-22	5512 090-03	T15-B
STFCR/L 2525 M22	25	25	150	32					
STFCR/L 3225 P22	32	32	170	32					

SISTEMA DE FIXAÇÃO POR PARAFUSO TORX

STGCR

Suporte para torneiar 91° com pastilha positiva triangular

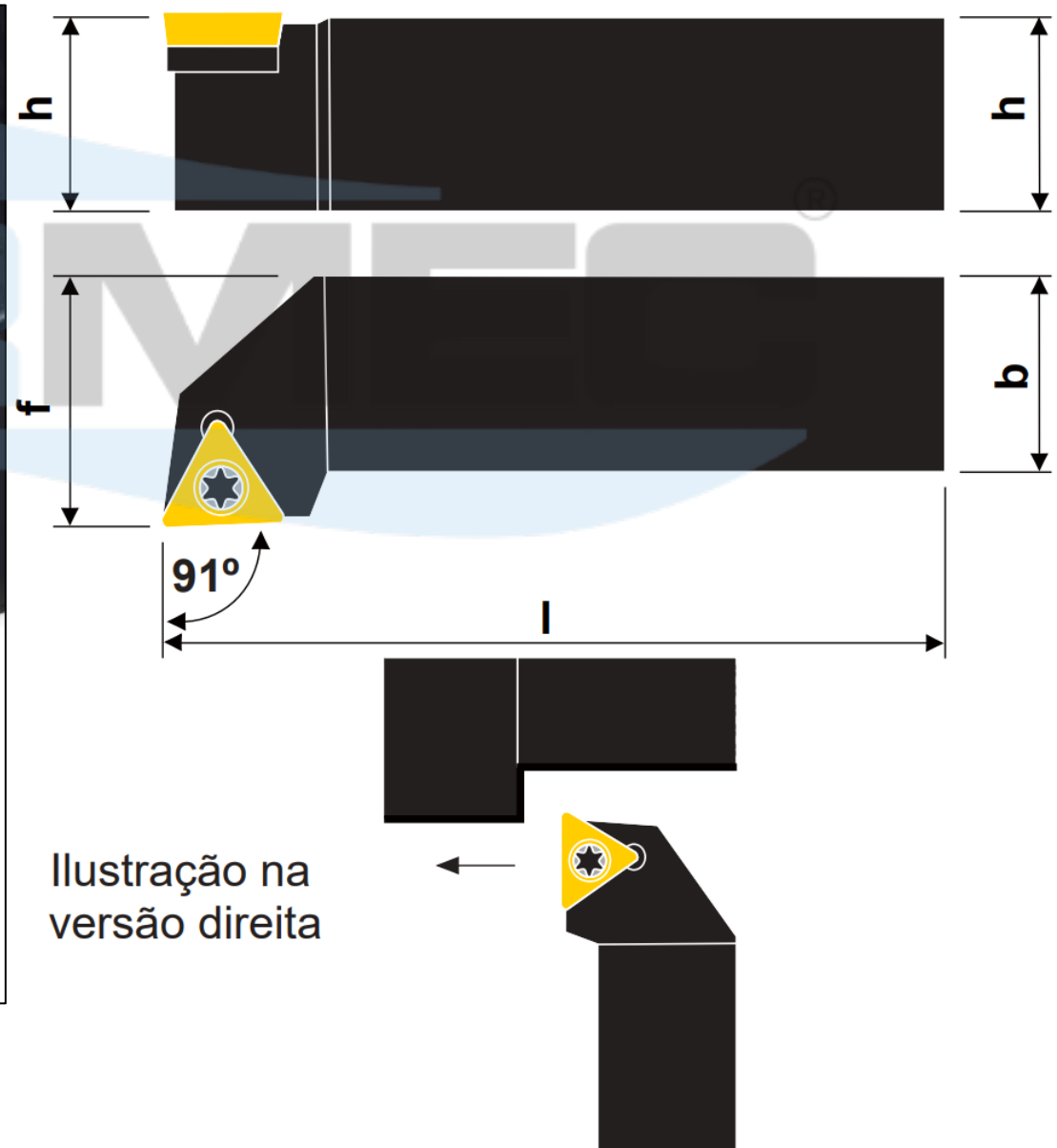

Produtos	Dimensões (mm)				Pastilha	Acessórios			
	h	b	l	f		Parafuso Torx	Calço	Parafuso do Calço	Chave Torx/Allen
STGCR/L 0808 D09	08	08	60	10	TC_0902	5513 020-05	-	-	T7-B
STGCR/L 1010 E09	10	10	70	12					
STGCR/L 1212 F11	12	12	80	16	TC_1102	5513 020-03	-	-	T7-B
STGCR/L 1616 H11	16	16	100	20					
STGCR/L 2020 K11	20	20	125	25					
STGCR/L 2020 K16	20	20	125	25	TC_16T3	5513 020-01	5322 320-01	5512 090-01	T15-B C - 9/64
STGCR/L 2525 M16	25	25	150	32					
STGCR/L 2525 M22	25	25	150	32	TC_2204	5513 020-18	5322 320-22	5512 090-03	T15-B
STGCR/L 3225 P22	32	25	170	32					

SISTEMA DE FIXAÇÃO POR PARAFUSO TORX

STTCR

Suporte para torneiar 60° com pastilha positiva triangular



Ilustração na versão direita

Produtos	Dimensões (mm)				Pastilha	Acessórios			
	h	b	l	f		Parafuso Torx	Calço	Parafuso do Calço	Chave Torx
STTCR/L 1212 F11	12	12	80	9	TC_1102	5513 020-03	-	-	T7-B
STTCR/L 1616 H11	16	16	100	13					
STTCR/L 1616 H16	16	16	100	13	TC_16T3	5513 020-01	5322 320-01	5512 090-01	T15-B C - 9/64
STTCR/L 2020 K16	20	20	125	17					
STTCR/L 2525 M16	25	25	150	22					

SISTEMA DE FIXAÇÃO POR PARAFUSO TORX

SVACR

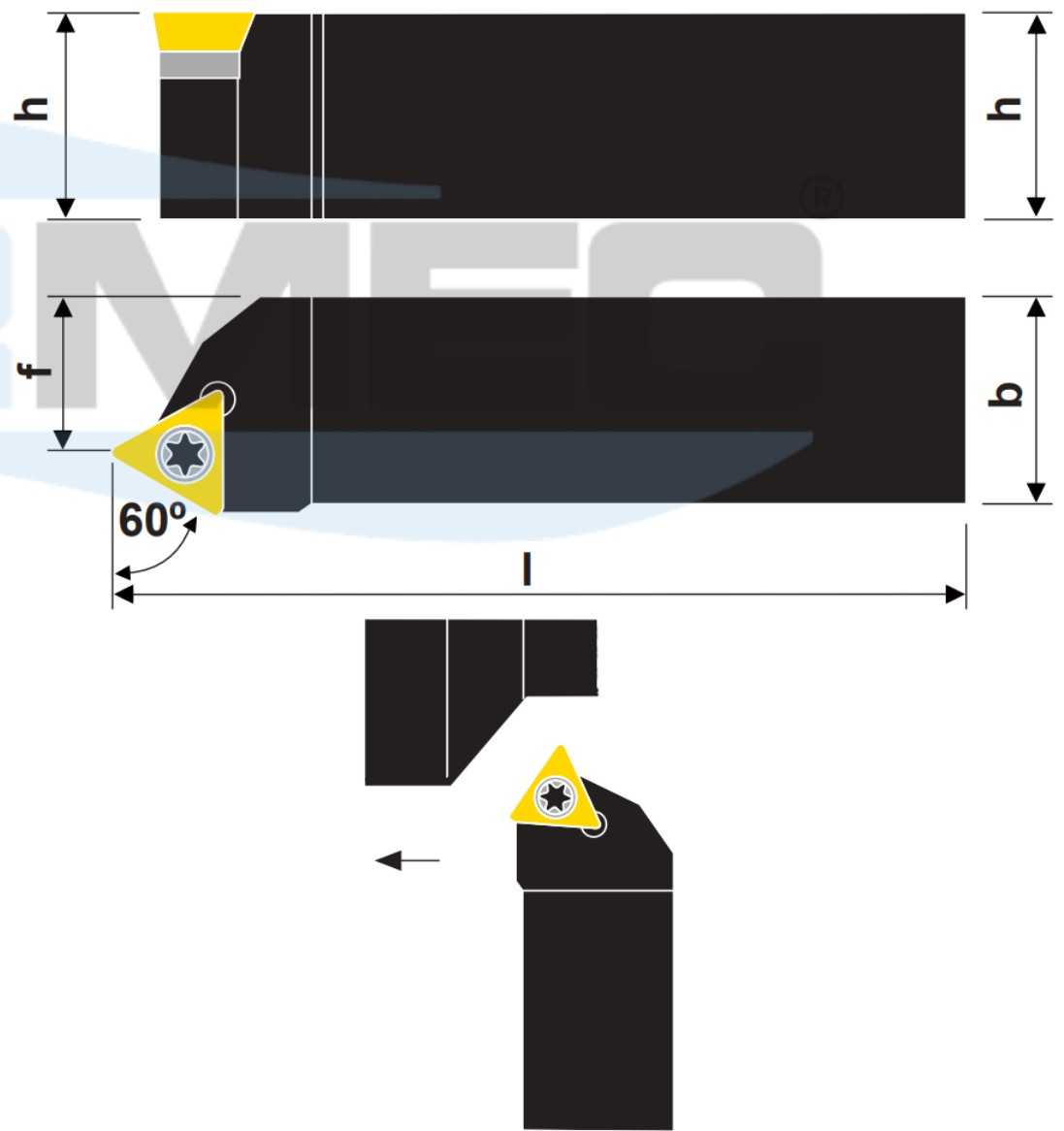
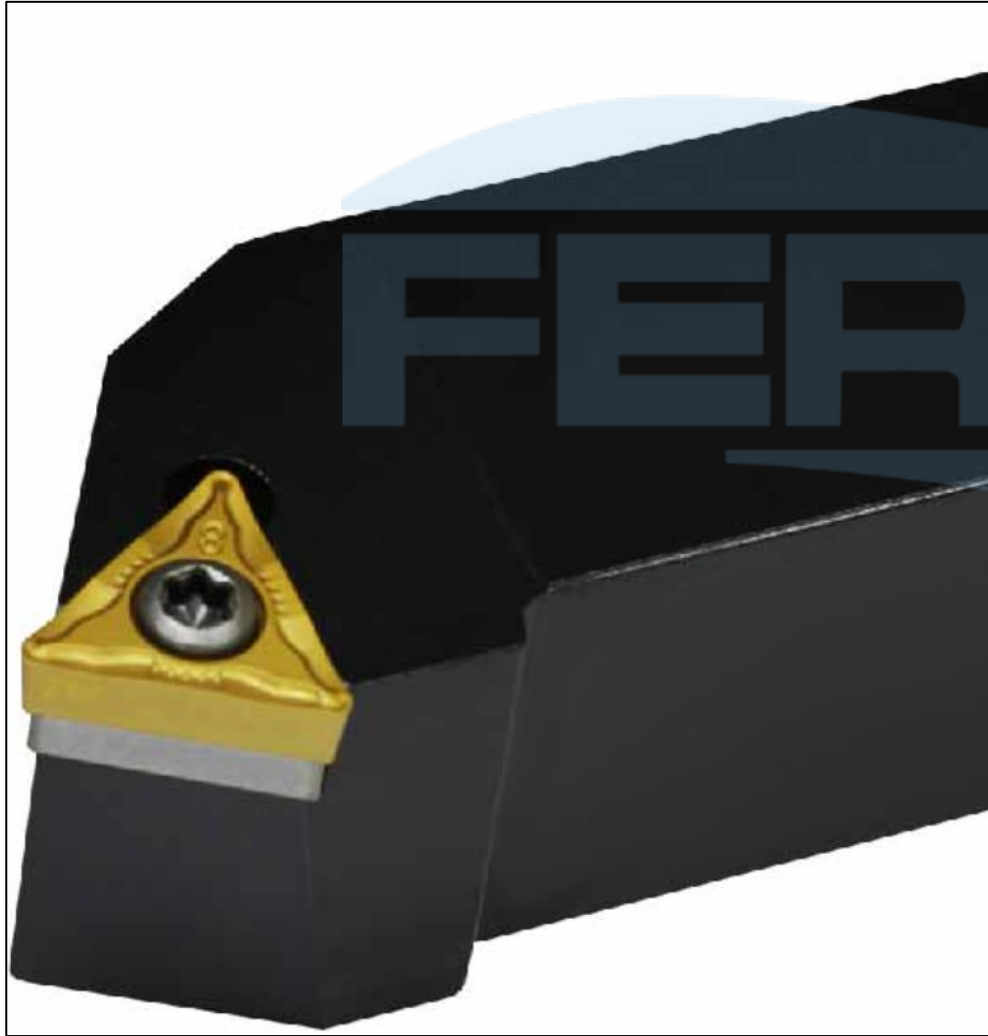
Suporte para torneiar e facear 90° com pastilha positiva 35°







Ilustração na versão direita

Produtos	Dimensões (mm)				Pastilha 	Acessórios			
	h	b	l	f		 Parafuso Torx	 Calço	 Parafuso do Calço	 Chave Allen
SVACR/L 1010 M11	10	10	150	10	VB_1103 TC_1103	5513 020-03	-	-	T7-B
SVACR/L 1212 M11	12	12	150	12					
SVACR/L 1616 M11	16	16	150	16					
SVACR/L 2020 M16	20	20	150	20	VB_1604 VC_1604	5513 020-01	5322 270-01	5512 090-01	T15-B C - 9/64

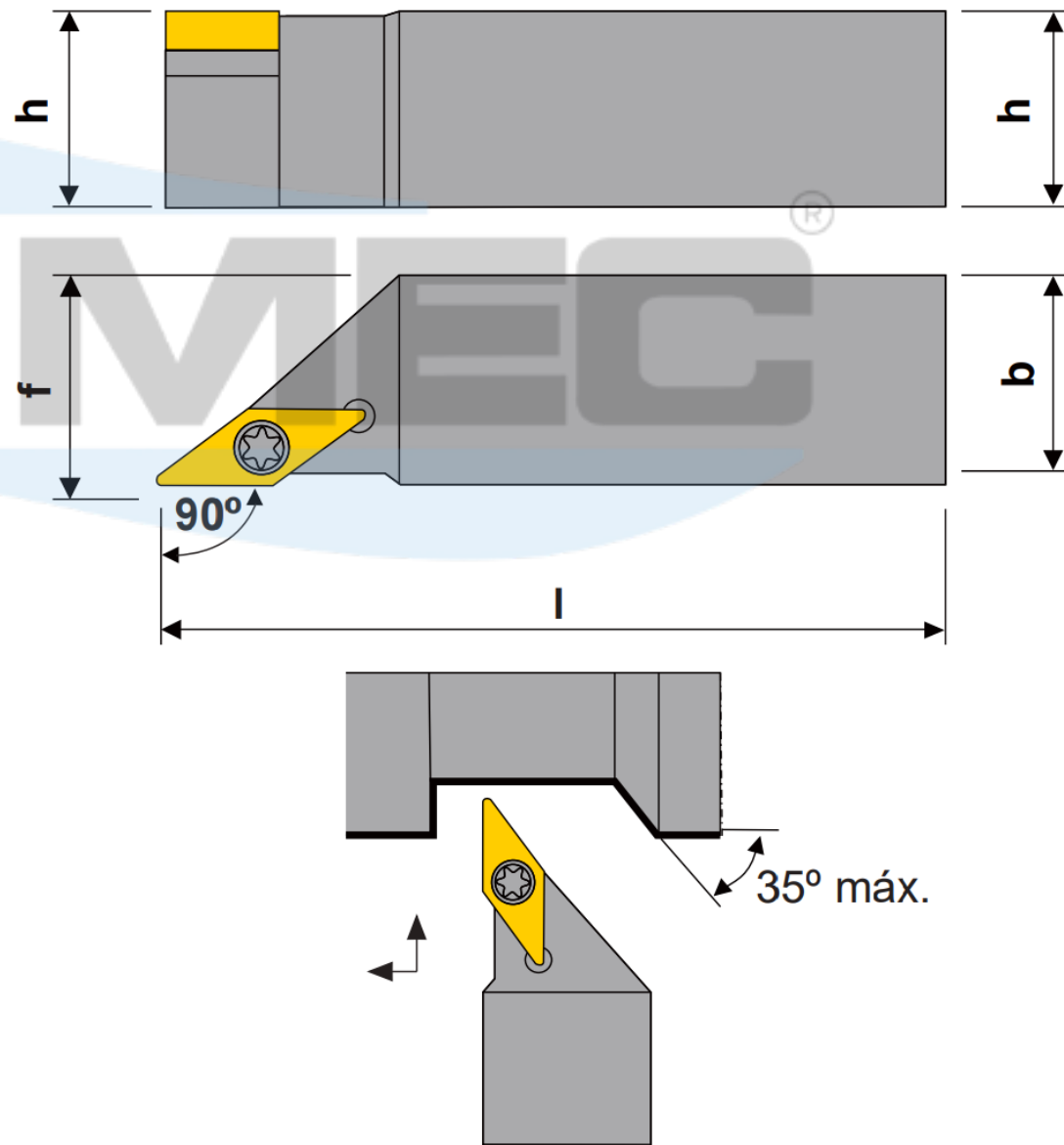
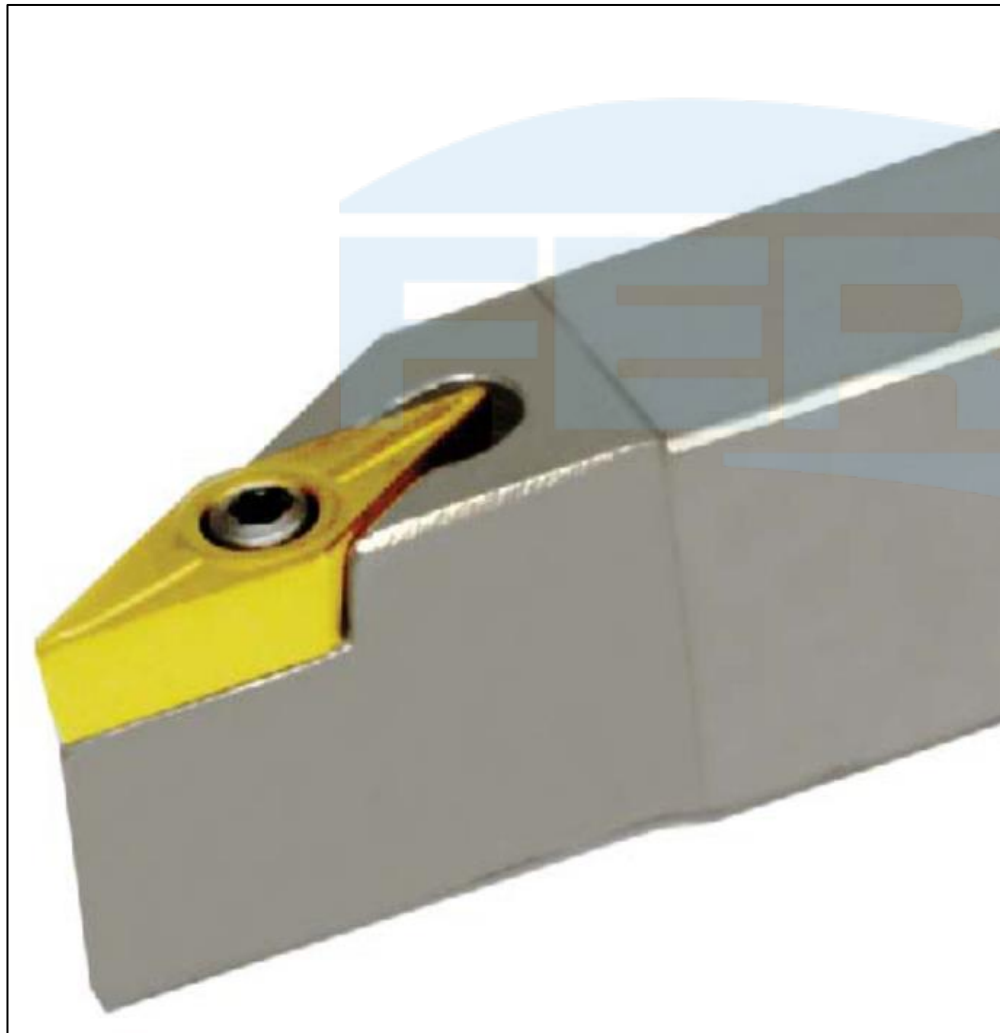
SISTEMA DE FIXAÇÃO POR PARAFUSO TORX TORX SVHBR

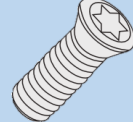
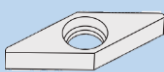
Suporte para torneiar e facear $107^{\circ}30'$ com pastilha positiva 35°







Ilustração na versão direita

Produtos	Dimensões (mm)				Pastilha 	Acessórios			
	h	b	l	f		 Parafuso Torx	 Calço	 Parafuso do Calço	 Chave Allen
SVHBR/L 2020 K16	20	20	125	25	VB_1604 VC_1604	5513 020-01	5322 270-01	5512 090-01	T15-B C - 9/64
SVHBR/L 2525 M16	25	25	150	32					
SVHBR/L 3225 P16	32	25	170	32					

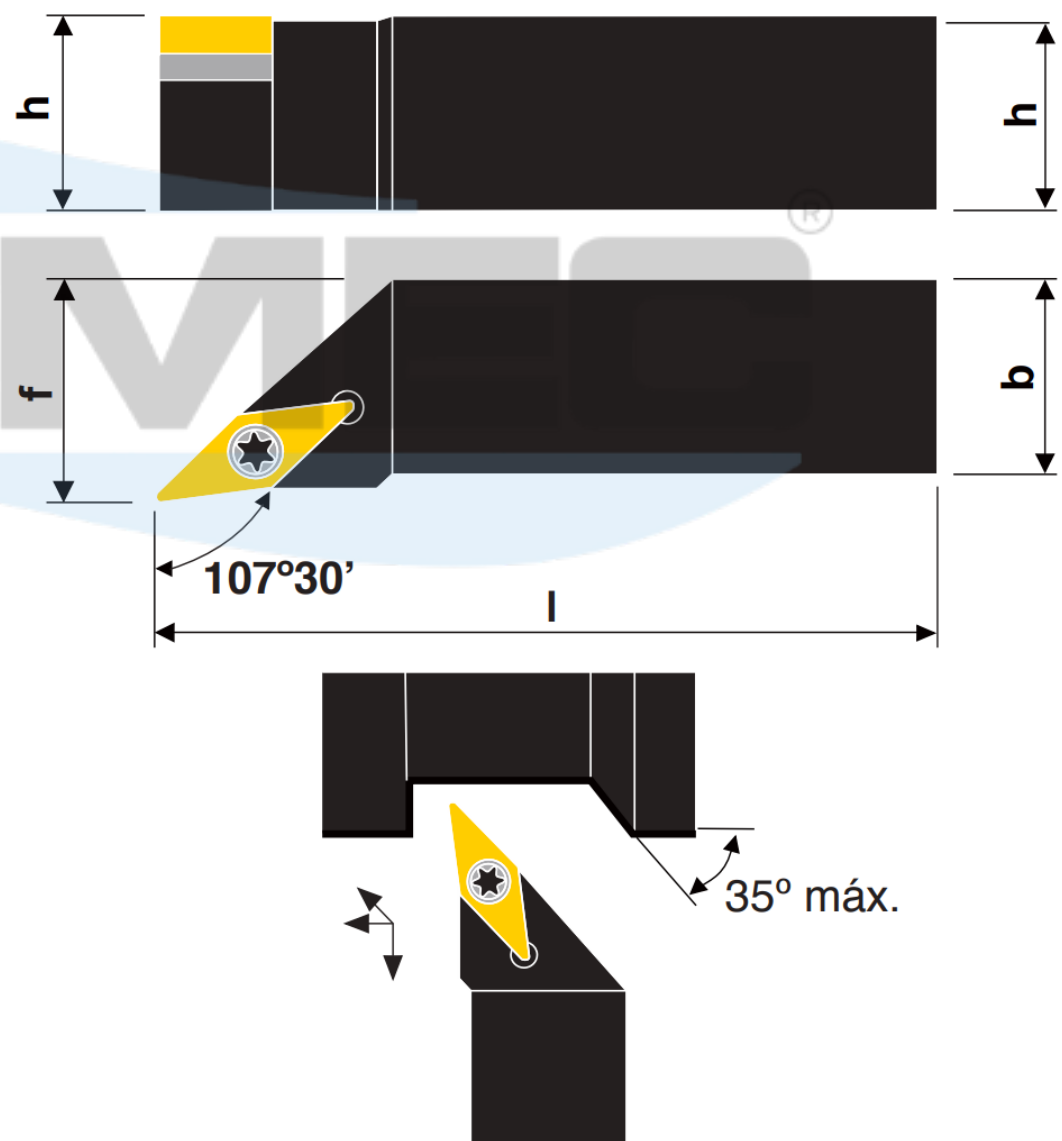
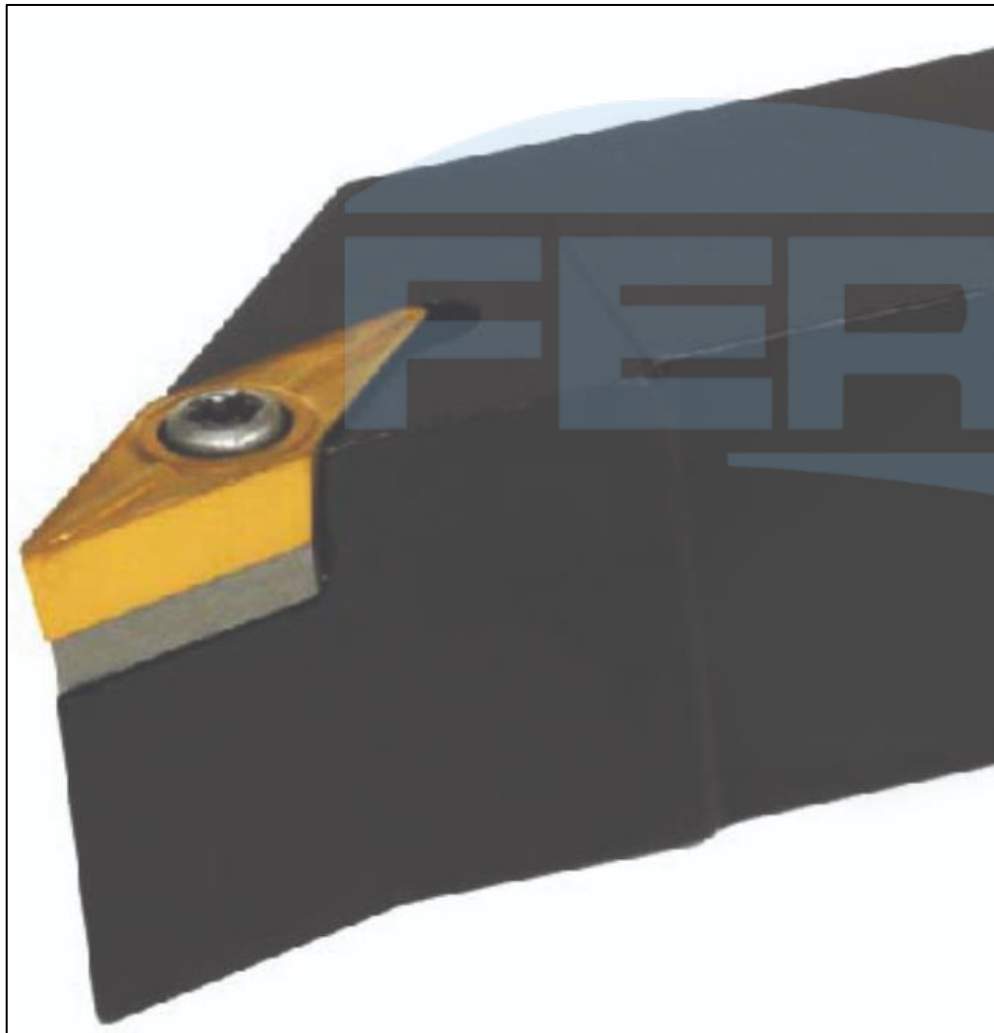
SISTEMA DE FIXAÇÃO POR PARAFUSO TORX

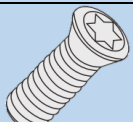
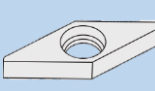
SVHCR-R2

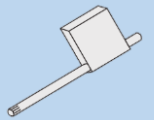
Suporte para torneiar e facear 107°30' com pastilha positiva 35°







Ilustração na versão direita

Produtos	Dimensões (mm)				Pastilha	Acessórios			
	h	b	l	f		 Parafuso Torx	 Calço	 Parafuso do Calço	 Chave Torx / Allen
SVHCR/L 2525 M22-R2	25	25	150	32	VC GT 220530	5513 020-18	5322 270-04	5512 090-03	T51-B / C - 4

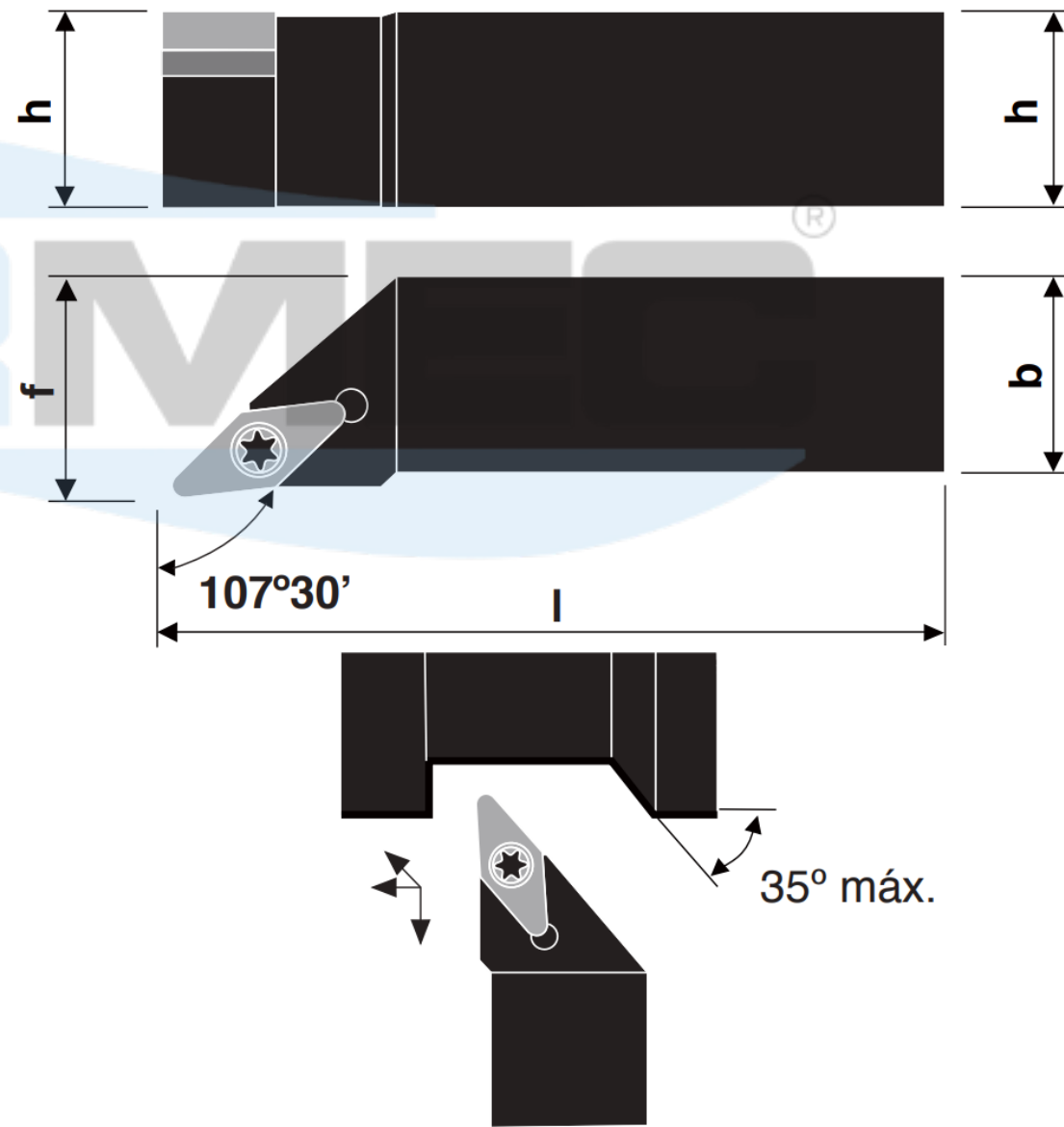
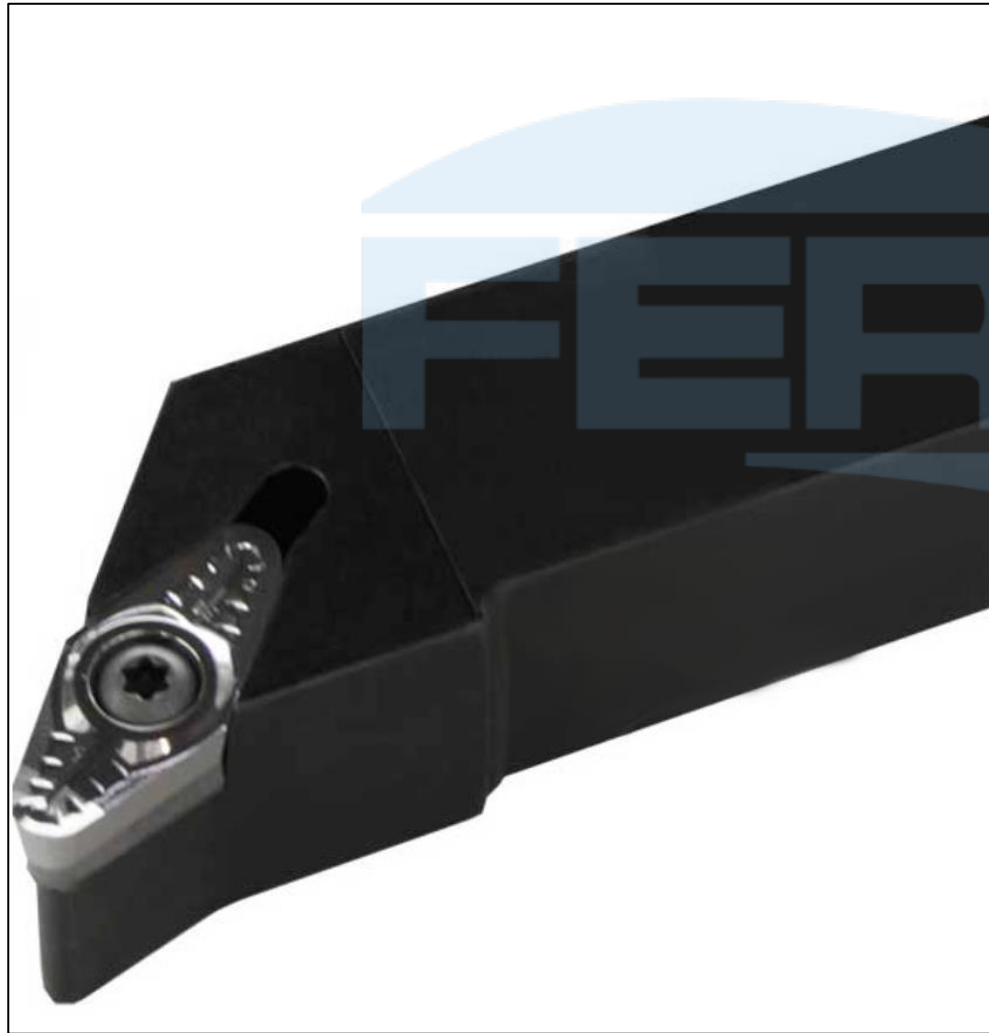
SISTEMA DE FIXAÇÃO POR PARAFUSO TORX

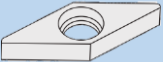
SVJCR / SVJBR

Suporte para torneiar e facear 93° com pastilha positiva 35°



Ilustração na versão direita

Produtos	Dimensões (mm)				Pastilha 35°	Acessórios			
	h	b	l	f		Parafuso Torx	Calço	Parafuso do Calço	Chave Torx/Allen
SVJCR/L 1212 F11	12	12	80	16	VB_1103 VC_1103	5513 020-03	-	-	T7-B
SVJCR/L 1616 H11	16	16	100	20					
SVJCR/L 2020 K11	20	20	125	25					
SVJCR/L 2525 M11	25	25	150	32					
SVJCR/L 1010 K11 - S	10	10	125	10					
SVJCR/L 1212 K11 - S	12	12	125	12					
SVJCR/L 1616 K11 - S	16	16	125	16					
SVJBR/L 2020 K16	20	20	125	25	VB_1604 VC_1604	5513 020-01	5322 270-01	5512 090-01	T15-B C - 9/64
SVJBR/L 2525 M16	25	25	150	32					
SVJBR/L 3225 P16	32	25	170	32					

SISTEMA DE FIXAÇÃO POR PARAFUSO TORX

SVVBN / SVVCN

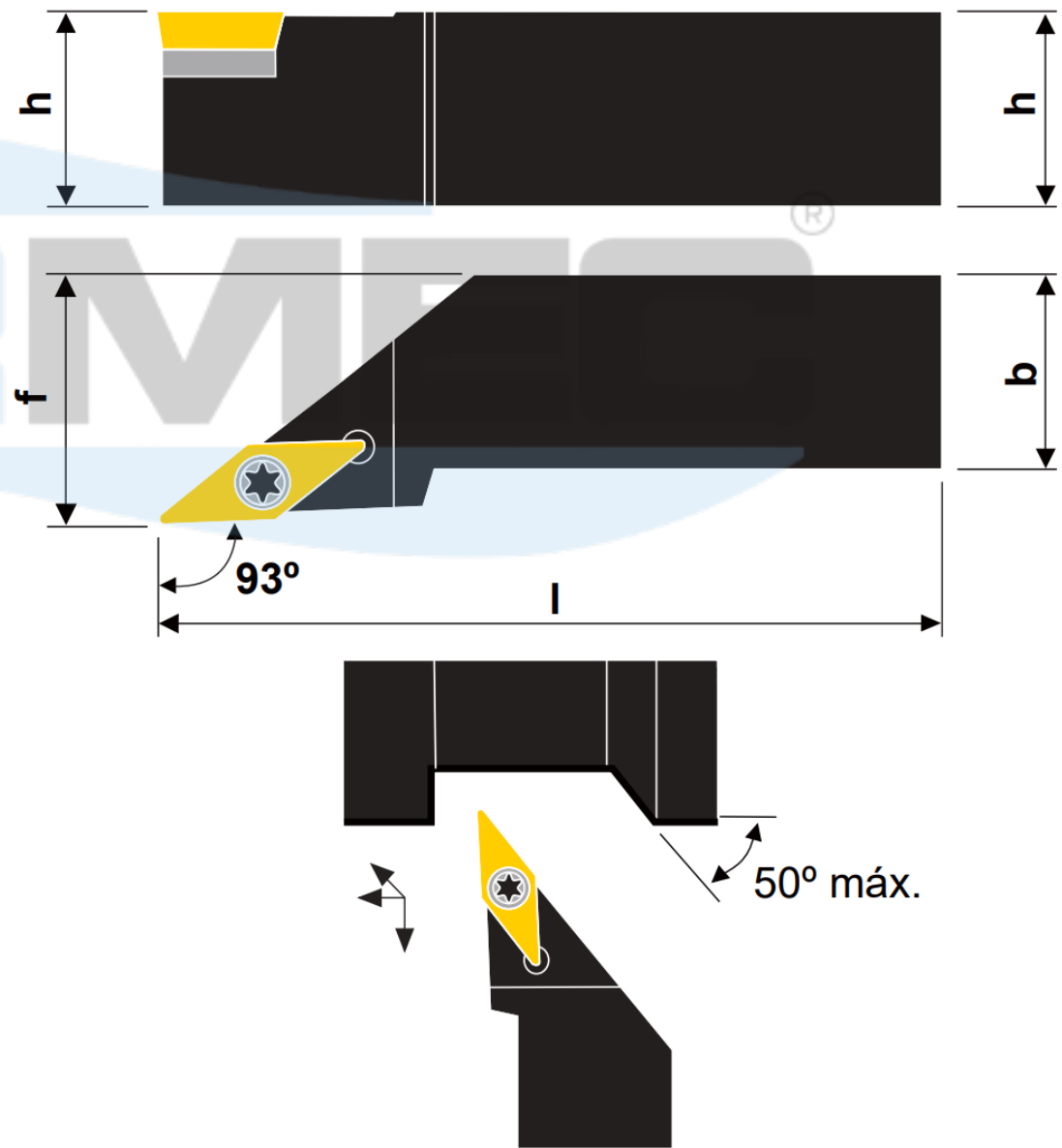
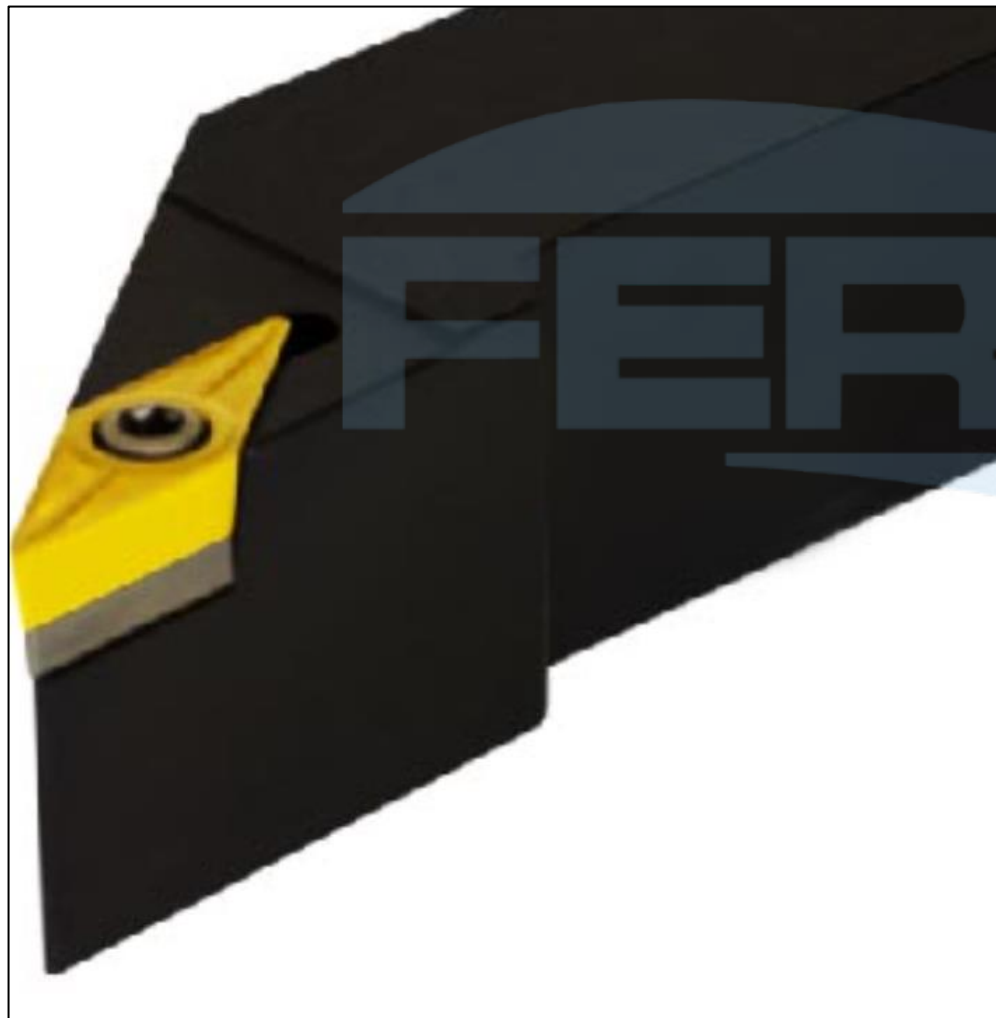
Suporte neutro para torneiar $72^{\circ}30'$ com pastilha positiva 35°







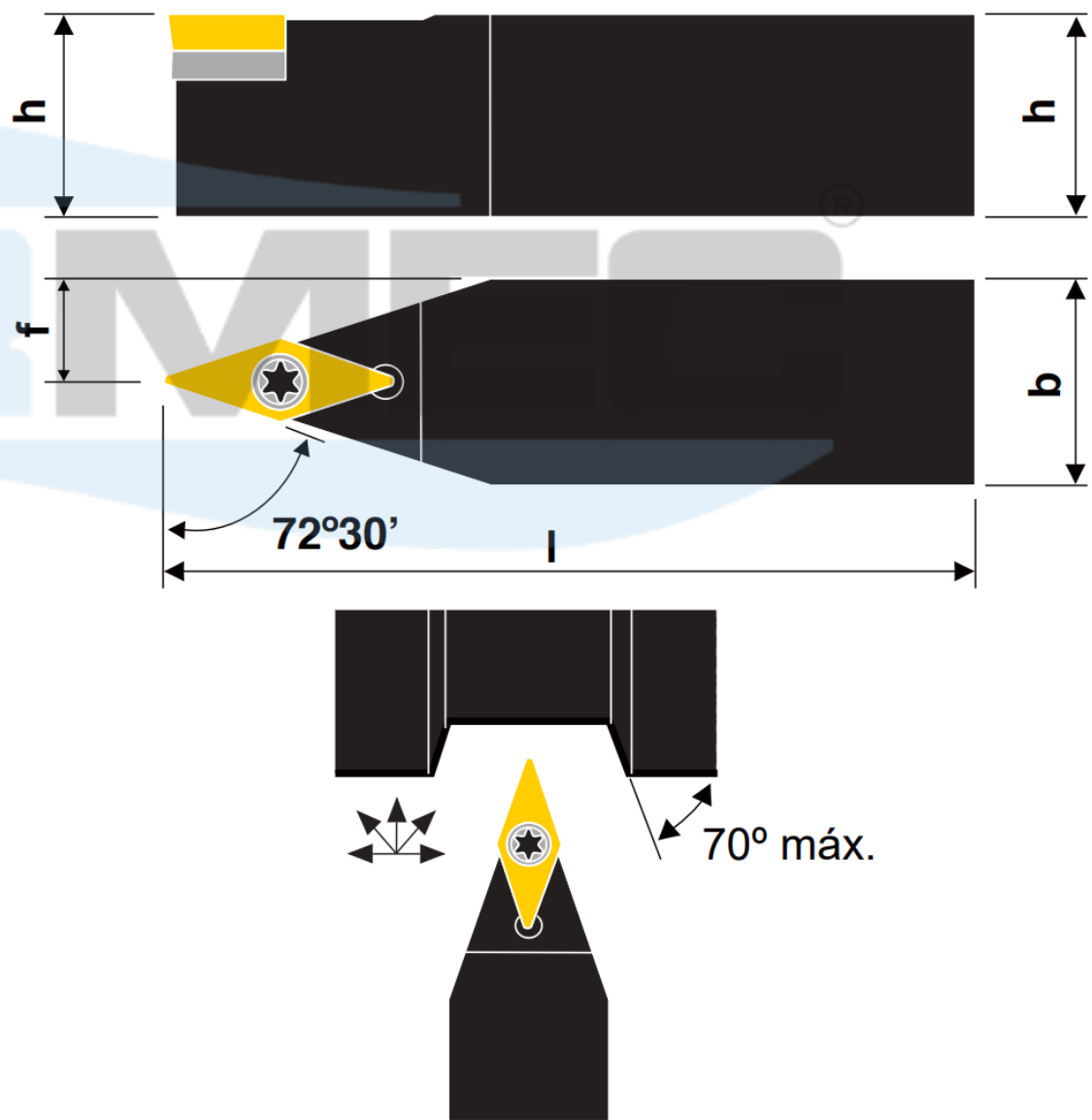

Ilustração na versão direita

Produtos	Dimensões (mm)				Pastilha 	Acessórios			
	h	b	l	f		 Parafuso Torx	 Calço	 Parafuso do Calço	 Chave Torx / Allen
SVVCN 1212 F11	12	12	80	6,3	VB_1103 VC_1103	5513 020-03	-	-	T7-B
SVVCN 1616 H11	16	16	100	8,3					
SVVCN 2020 K11	20	20	125	10,3					
SVVCN 2525 M11	25	25	150	12,8					
SVVBN 2020 K16	20	20	125	10,6	VB_1604 VC_1604	5513 020-01	5322 270-01	5512 090-01	T15-B C - 9/64
SVVBN 2525 M16	25	25	150	13,1					
SVVBN 3225 P16	32	25	170	13,1					
SVVCN 2525 M22 - R2	25	25	150	13,1	VCGT 220530	5513 020-18	5322 270-04	5512090-03	T51-B / C - 4

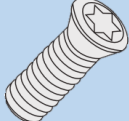
SISTEMA DE FIXAÇÃO POR PARAFUSO TORX

SVPBR

Suporte para torneiar e facear 95° com pastilha positiva 35°







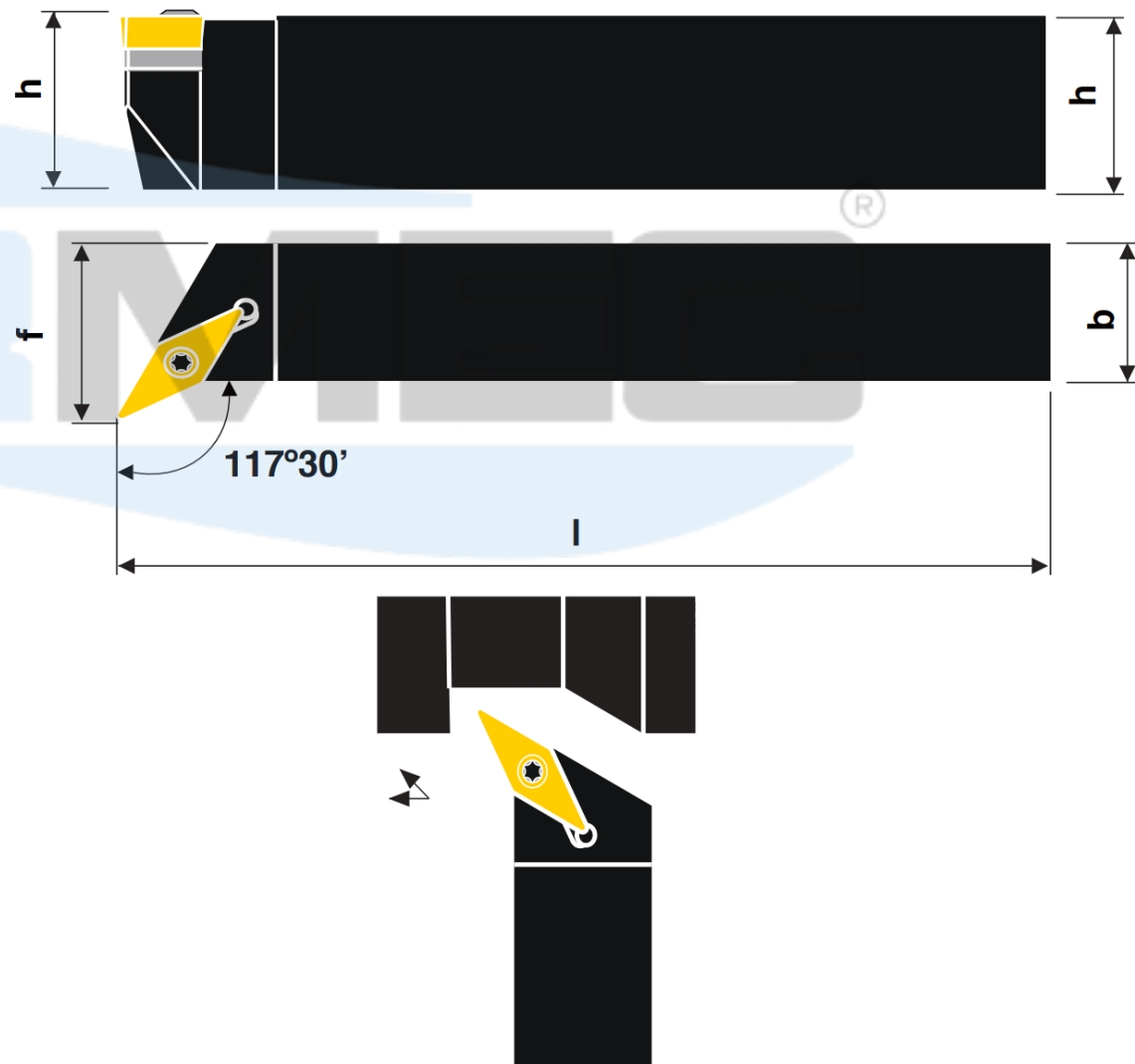

Ilustração na versão direita

Produtos	Dimensões (mm)				Pastilha 	Acessórios			
	h	b	l	f		 Parafuso Torx	 Calço	 Parafuso do Calço	 Chave Torx / Allen
SVPBR/L 2020 K16	20	20	125	25	VB_1604 VC_1604	5513 020-01	5322 270-01	5512 090-01	TX 15 1267B
SVPBR/L 2525 M16	25	25	150	32					
SVPBR/L 3225 P16	32	25	170	32					

SISTEMA DE FIXAÇÃO POR PARAFUSO TORX

SVLBR

Suporte para torneiar e facear 95° com pastilha positiva 35°







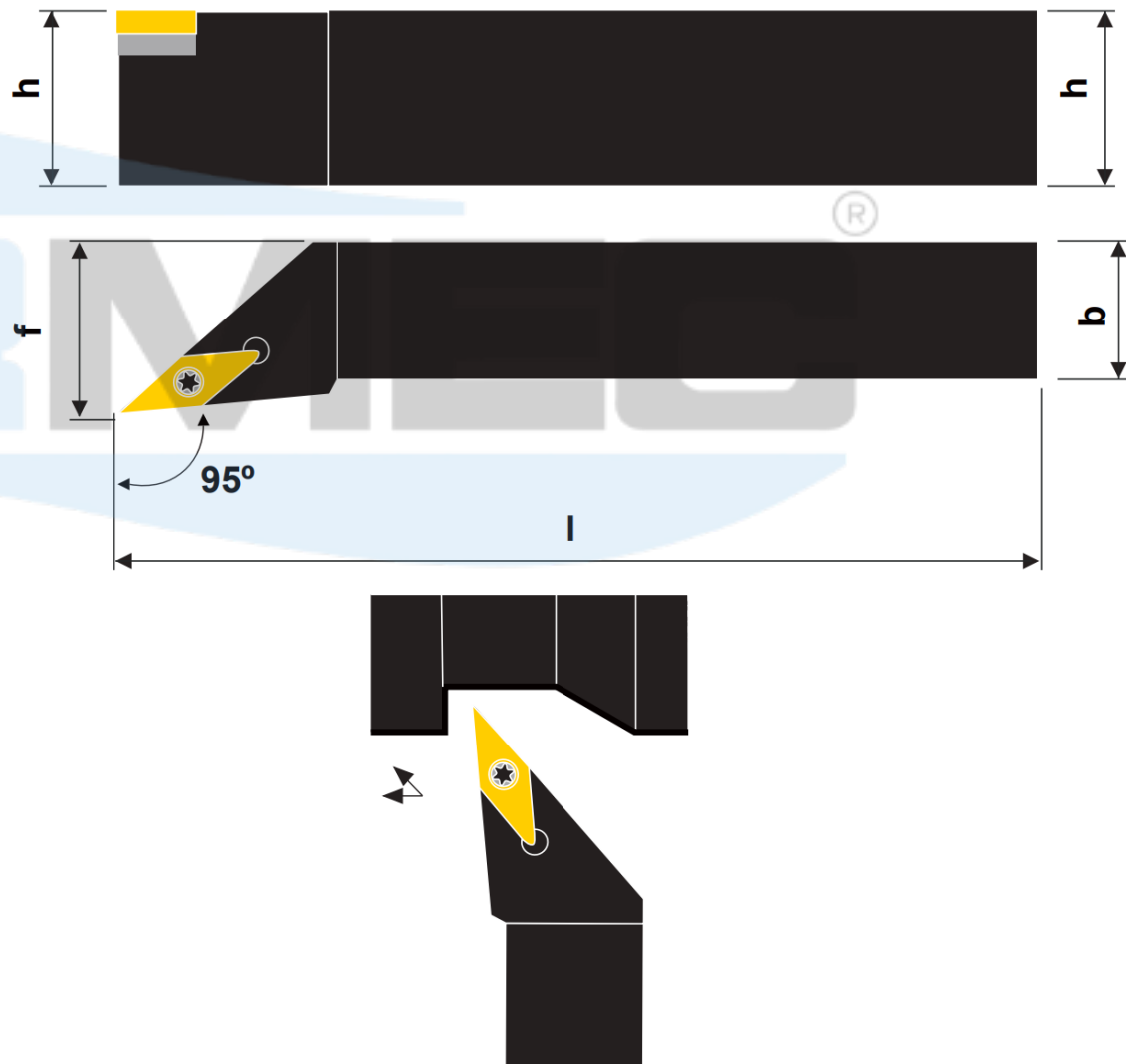
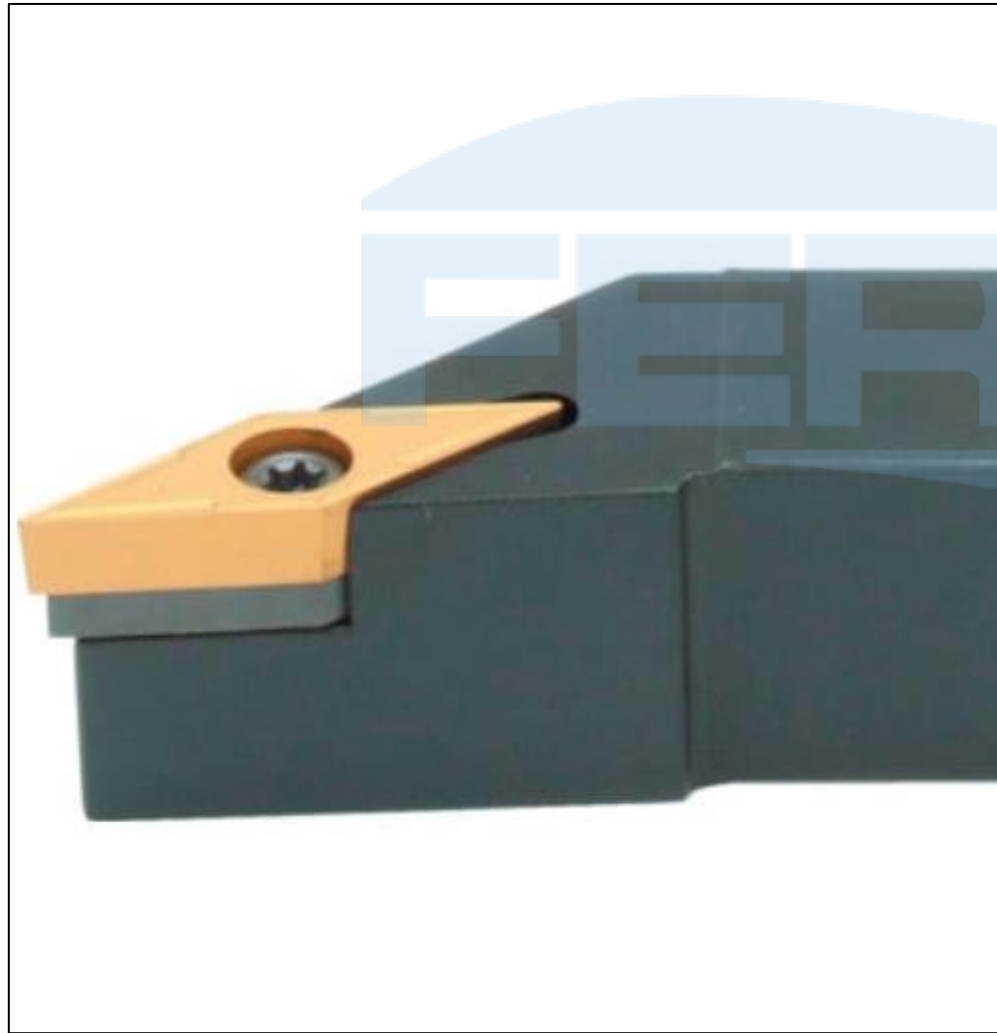

Ilustração na versão direita

Produtos	Dimensões (mm)				Pastilha 	Acessórios			
	h	b	l	f		 Parafuso Torx	 Calço	 Parafuso do Calço	 Chave Torx / Allen
SVLBR/L 2020 K16	20	20	125	25	VB_1604 VC_1604	5513 020-01	5322 270-01	5512 090-01	TX 15 1267B
SVLBR/L 2525 M16	25	25	150	32					
SVLBR/L 3225 P16	32	25	170	32					

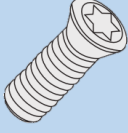
SISTEMA DE FIXAÇÃO POR PARAFUSO TORX

SVXCR

Suporte para torneiar e facear 112° com pastilha positiva 35°









Ilustração na versão direita

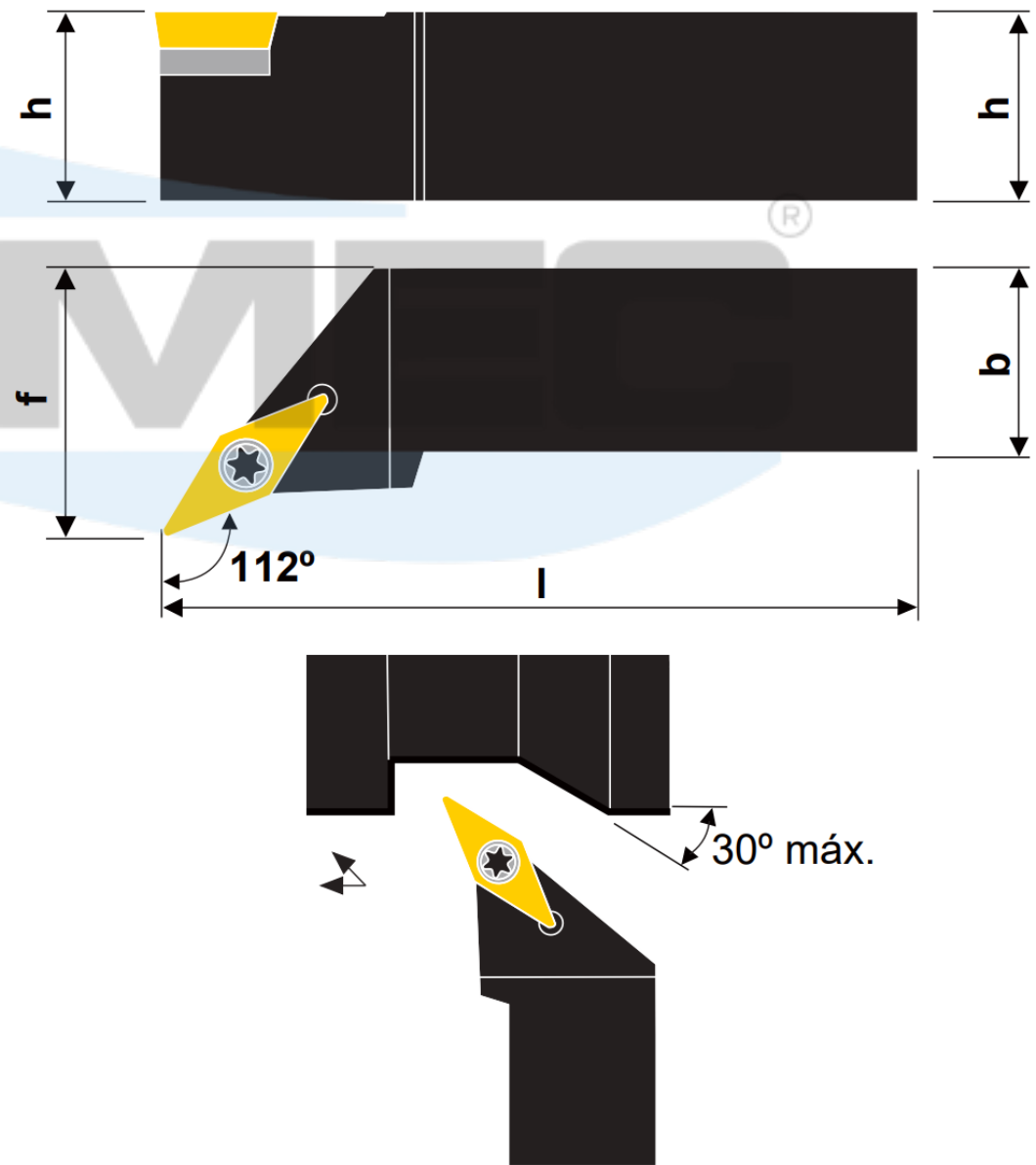

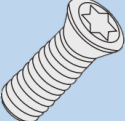



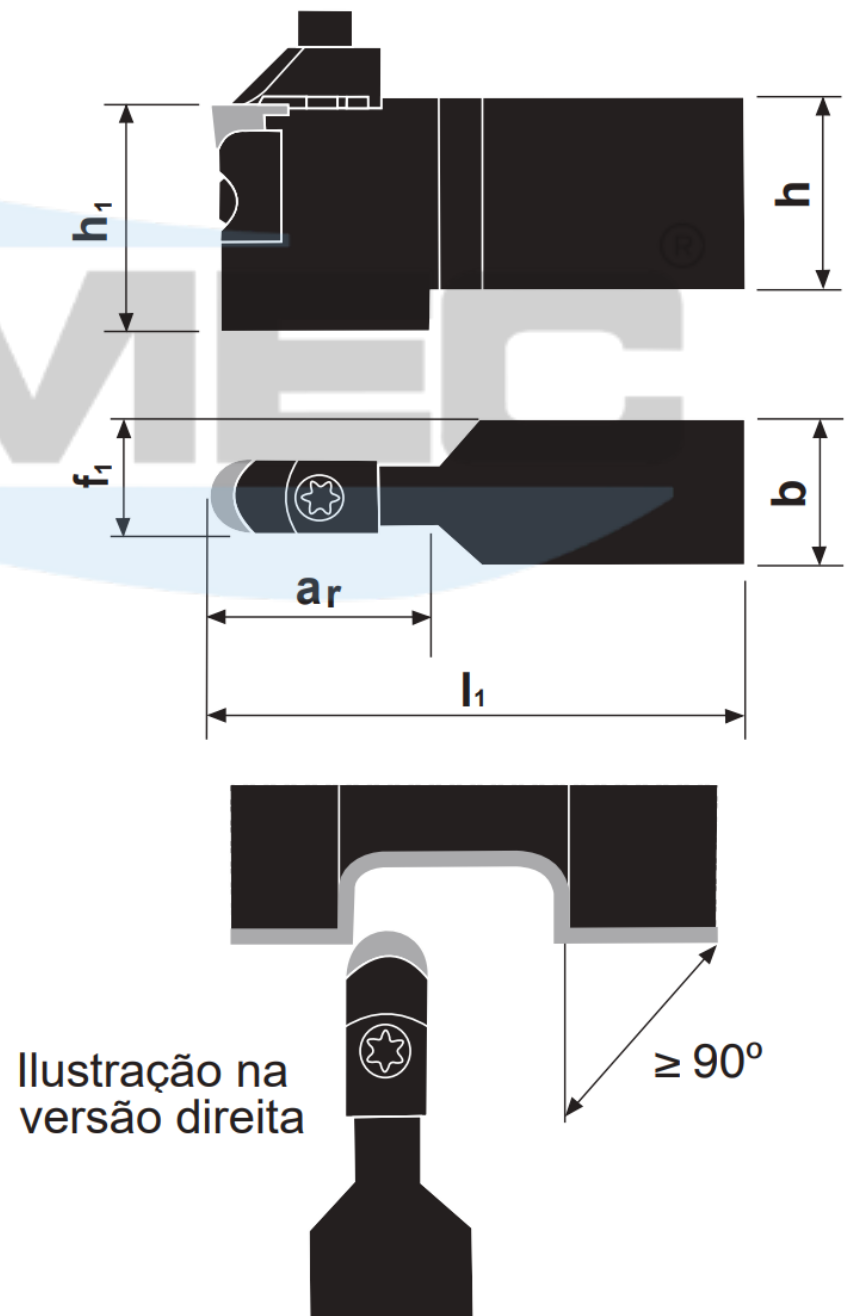
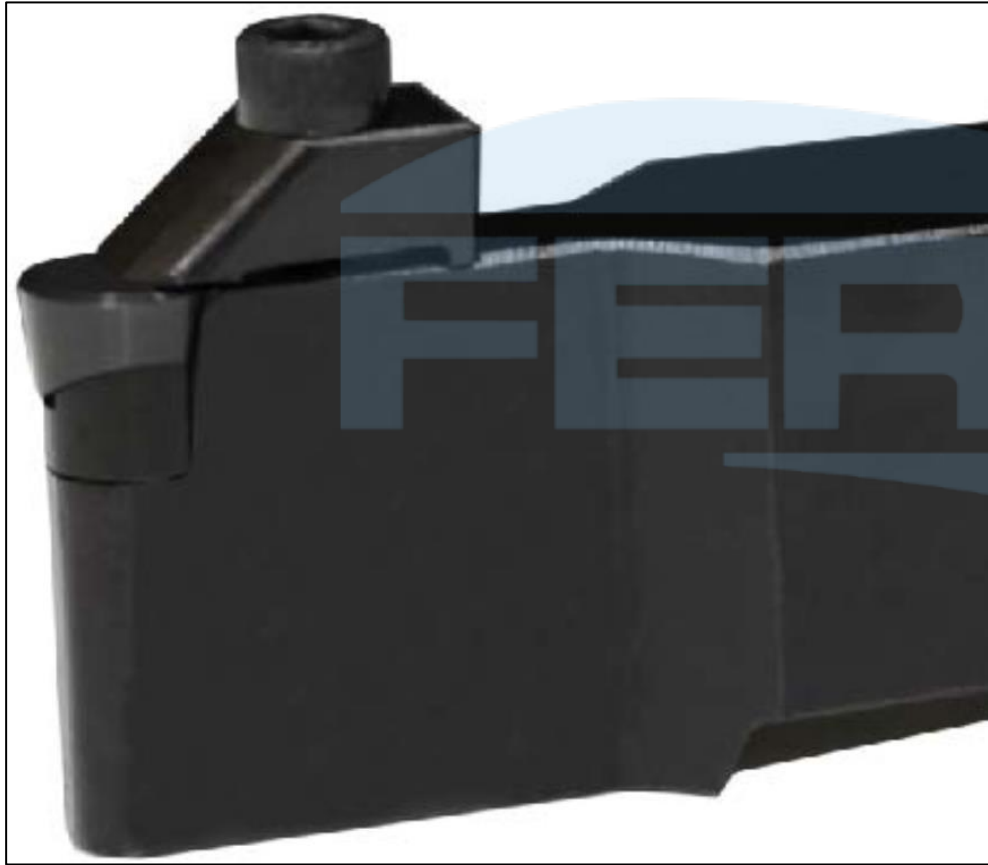

Produtos	Dimensões (mm)				Pastilha 	Acessórios			
	h	b	l	f		 Parafuso Torx	 Calço	 Parafuso do Calço	 Chave Torx / Allen
SVXCR/L 2020 K16	20	20	125	25	VB_1604 VC_1604	5513 020-01	5322 270-01	5512 090-01	T15-B C - 9/64
SVXCR/L 2525 M16	25	25	150	32					

SISTEMA DE FIXAÇÃO POR GRAMPO

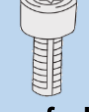
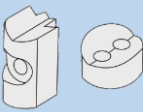
CRDCN

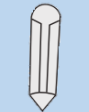
Suporte neutro para torneiar e facear com pastilha positiva redonda



Produtos	Dimensões (mm)						Pastilha	Acessórios					
	h	h1	b	l	f	ar			 Grampo	 Paraf. do grampo	 Calço	 Paraf. do Calço	 Rebite
CRDCN 2525 M06-A	25	30,1	25	150	15,6	19,4	RCGX 060600		M6x20	5321 066-01	M2,5x10	-	C - 2 C - 5
CRDCN 3225 P06-A	32	38,1	25	170	15,6	19,4							
CRDCN 2525 M09-A	25	30,1	25	150	17,2	29	RCGX 090700		M5x12	5321 065-01	M3,2x12	-	C - 2,5 C - 4
CRDCN 3225 P09-A	32	38,1	25	170	17,2	29							
CRDCN 2525 M12-A	25	30,1	25	150	18,8	38,5	RCGX 120700		M6x20	5321 065-02	M5x16	-	C - 3 C - 5
CRDCN 3225 M12-A	32	38,1	25	170	18,8	28,5							
CRDCN 5040 T15-ID	50	50	40	300	27,9	35	RCGX 151000	5412 126-01	M8x20	5321 210-03	-	3113 030-355	C - 6
CRDCN 5040 T19-ID	50	50	40	300	29,5	45	RCGX 191000	5412 126-02	M8x25	5321 210-04	-	3113 030-406	C - 6
CRDCN 5040 T25-ID	50	50	40	300	32,7	50	RCGX 251200	5412126-02	M8x25	5321 210-05	-	3113 030-406	C - 6

SISTEMA DE FIXAÇÃO POR GRAMPO

CRDCR

Suporte para torneiar e facear com pastilha positiva redonda







Ilustração na versão direita

Produtos	Dimensões (mm)						Pastilha	Acessórios					
	h	h1	b	l	f	ar		 Grampo	 Paraf. do grampo	 Calço	 Paraf. do Calço	 Rebite	 Chave Allen
CRDCR/L 2525 M06-A	25	30,1	25	150	25,6	19,4	RCGX 060600	5412 110-02	M6x20	5321 066-01	M2,5x10	-	C - 2 C - 5
CRDCR/L 3225 P09-A	32	32	25	170	25,8	29,5	RCGX 090700	5412 100-01	M5x12	5321 065-01	M3,5x12	-	C - 2,5 C - 4
CRDCR/L 3225 P12-A	32	32	25	170	25,9	38,5	RCGX 120700	5412 100-02	M6x20	5321 065-02	-	3113 030-355	C - 5

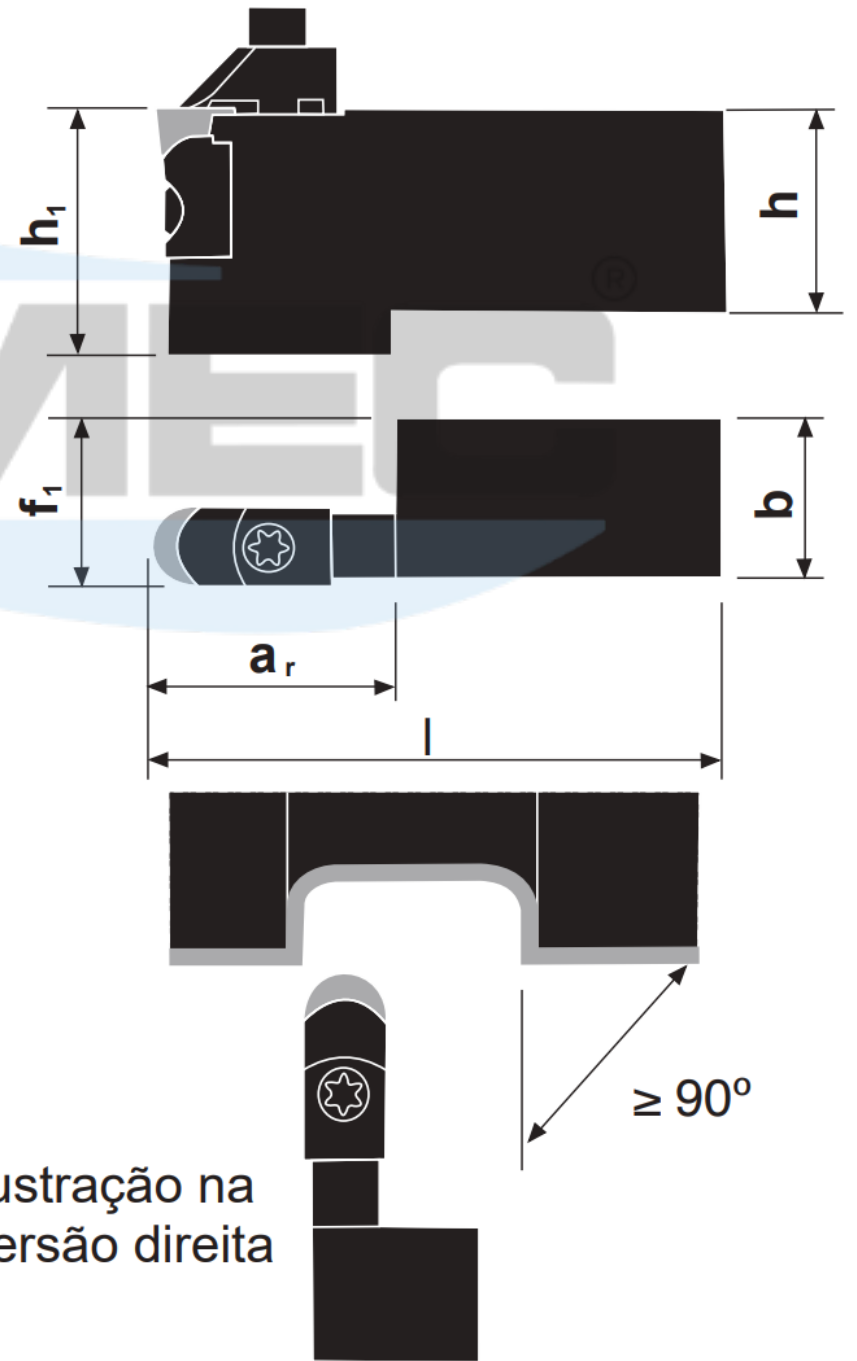
SISTEMA DE FIXAÇÃO POR GRAMPO

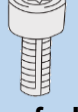
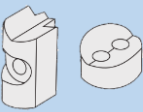
CSDNN

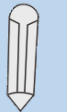
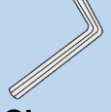
Suporte neutro para torneiar 45° com pastilha negativa quadrada



Ilustração na versão direita

Produtos	Dimensões (mm)				Pastilha	Acessórios			
	h	b	l	f		Grampo	Parafuso	Quebra-Cavaco	Chave Allen
CSDNN 2020 K09-IC	20	20	125	10,3	SNGN 0903	NC - 20	HT - 1	QSN - 12N	C - 1/8
CSDNN 2525 M09-IC	25	25	150	12,8					
CSDNN 3225 P09-IC	32	25	170	12,8					

SISTEMA DE FIXAÇÃO POR GRAMPO

CSKNR

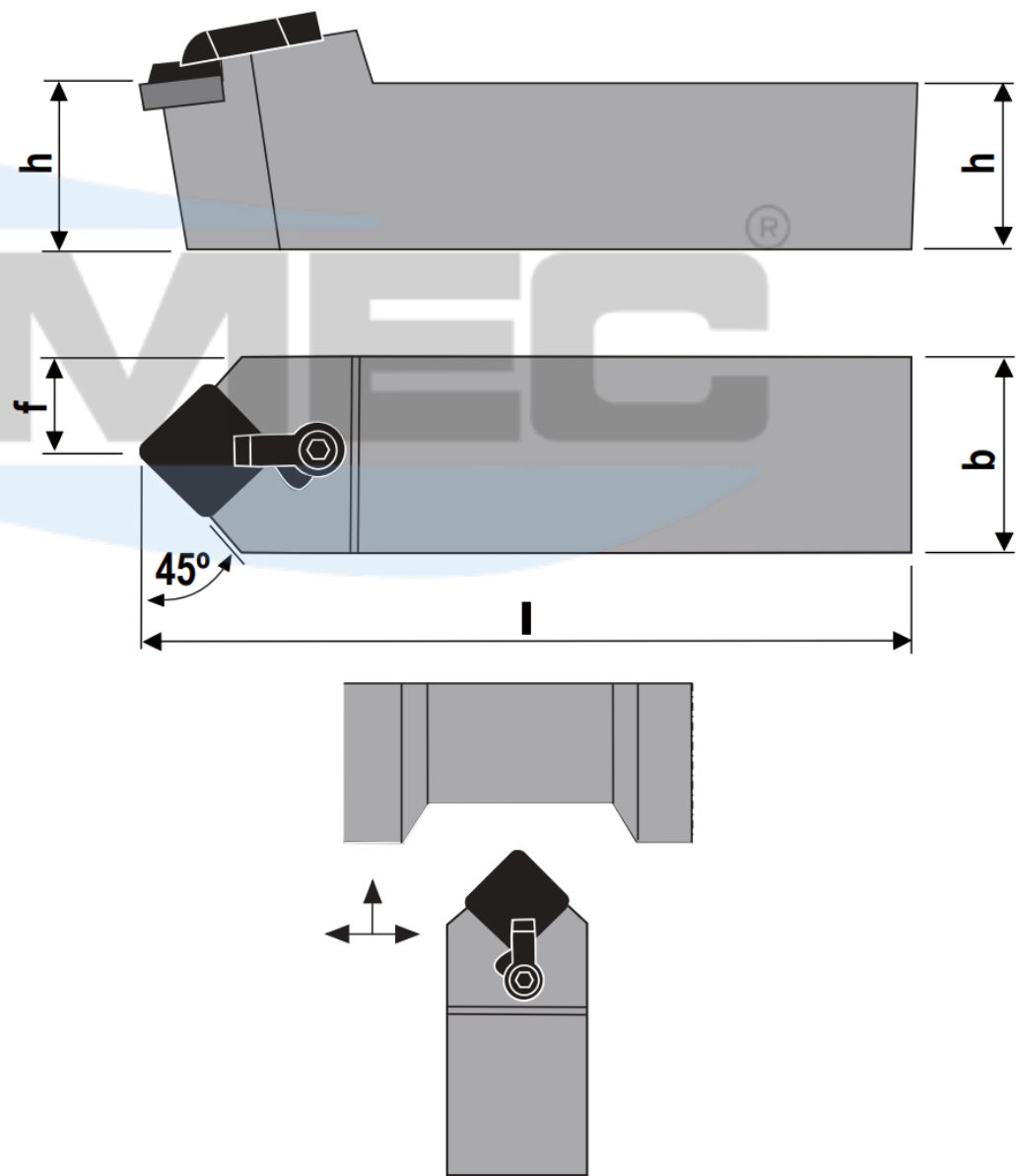
Suporte para facear 75° com pastilha negativa quadrada

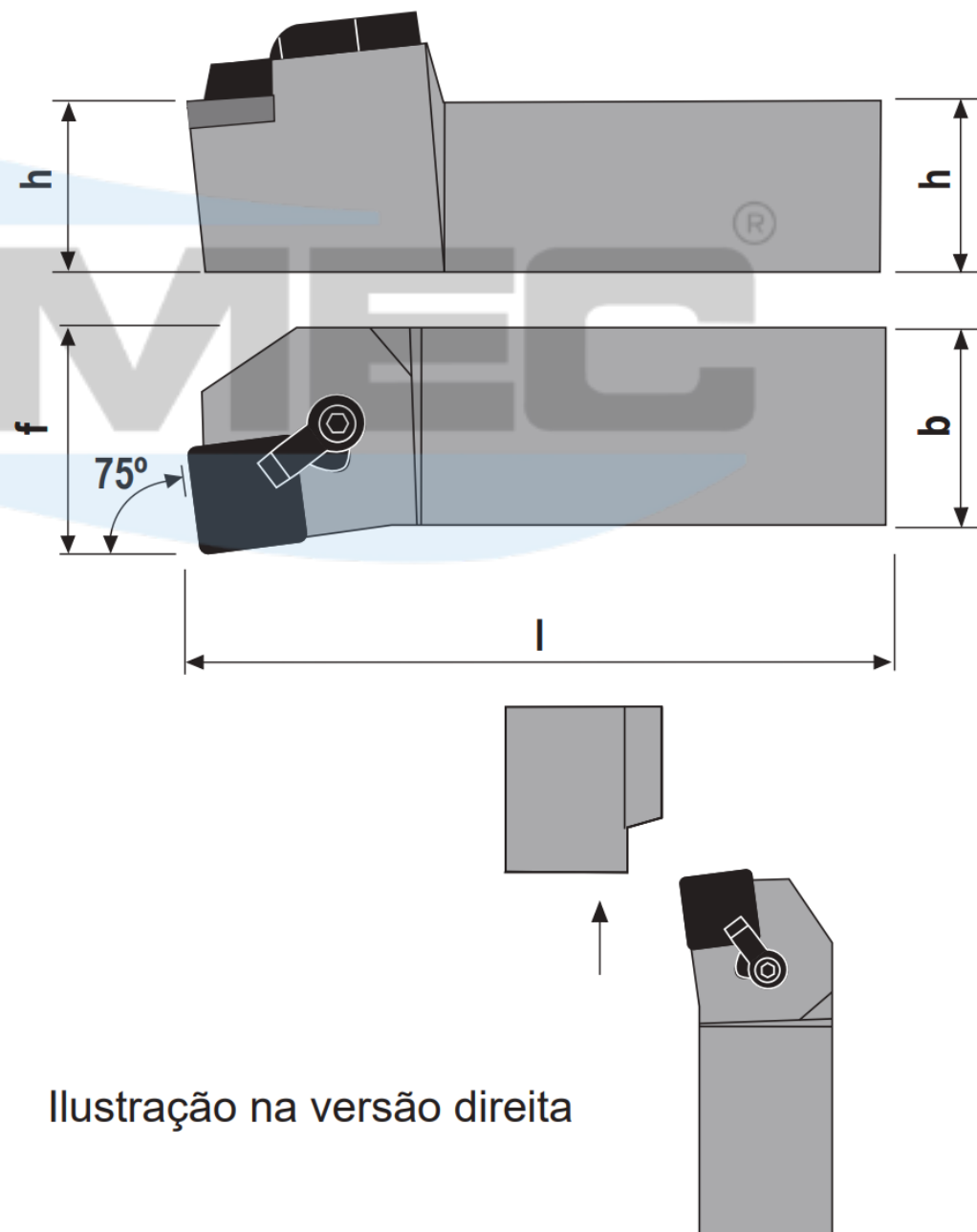

Produtos	Dimensões (mm)				Pastilha	Acessórios			
	h	b	l	f		Grampo	Parafuso	Quebra-Cavaco	Chave Allen
CSKNR 2020 K09	20	20	125	25	SNGN 0903	NC - 20	HT - 1	QSN - 16N	C - 1/8
CSKNR 2525 M09	25	25	150	32					
CSKNR 3225 P09	32	25	170	32					

SISTEMA DE FIXAÇÃO POR GRAMPO

CSSNR

Suporte para torneiar e facear 45° com pastilha negativa quadrada



Ilustração na versão direita

Produtos	Dimensões (mm)				Pastilha	Acessórios			
	h	b	l	f		Grampo	Parafuso	Quebra-Cavaco	Chave Allen
CSSNR 2020 K09	20	20	125	25	SNGN 0903	NC - 20	HT - 1	QSN - 12N	C - 1/8
CSSNR 2525 M09	25	25	150	32					
CSSNR 3225 P09	32	25	170	32					

SISTEMA DE FIXAÇÃO POR GRAMPO

CTFNR

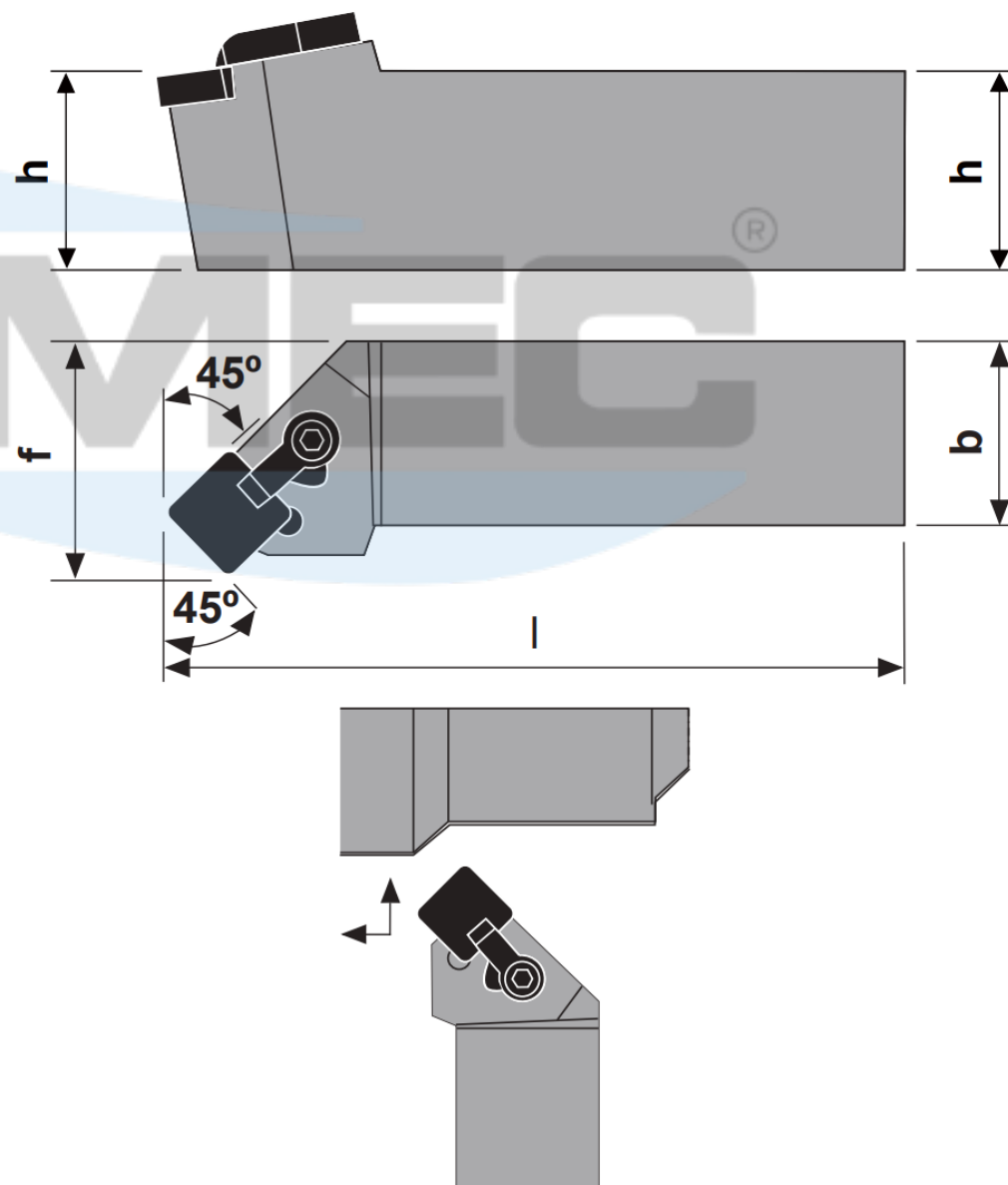
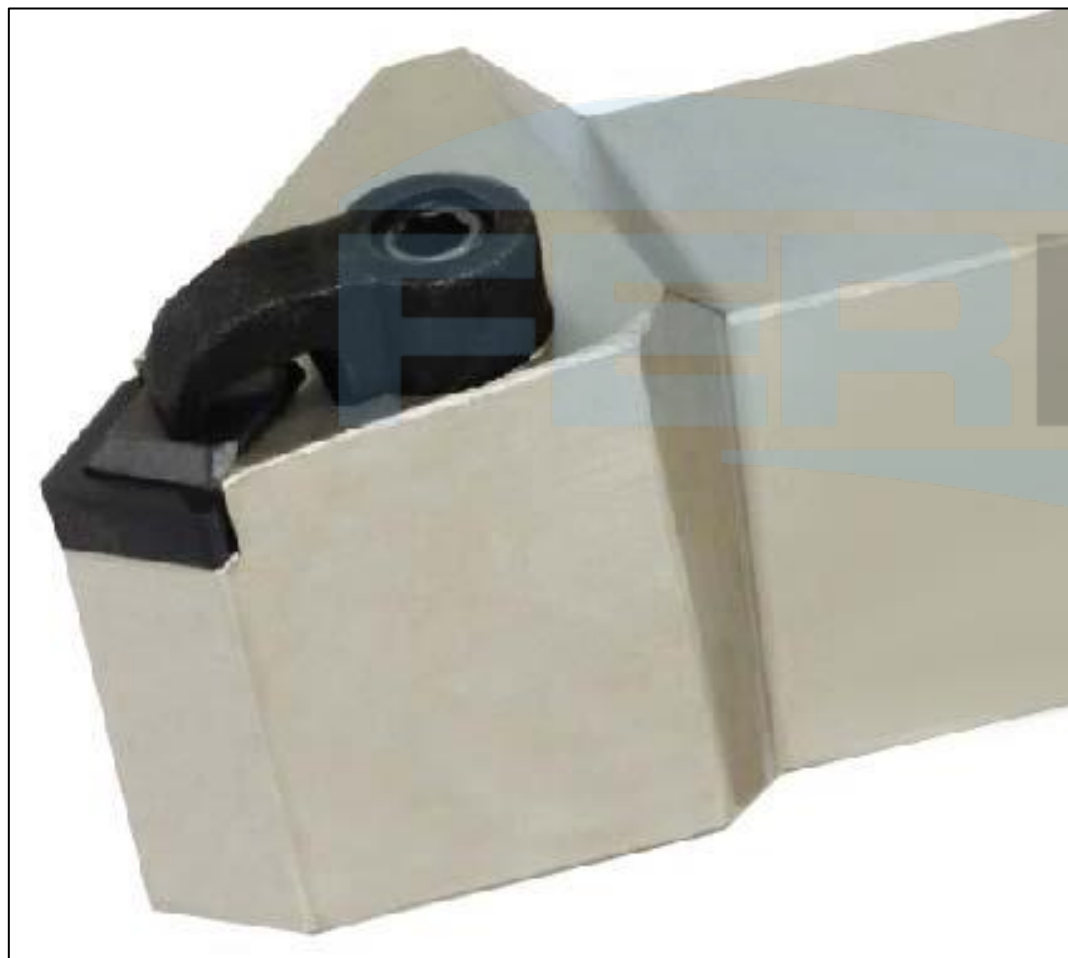
Suporte para facear 91° com pastilha negativa triangular









Ilustração na versão direita

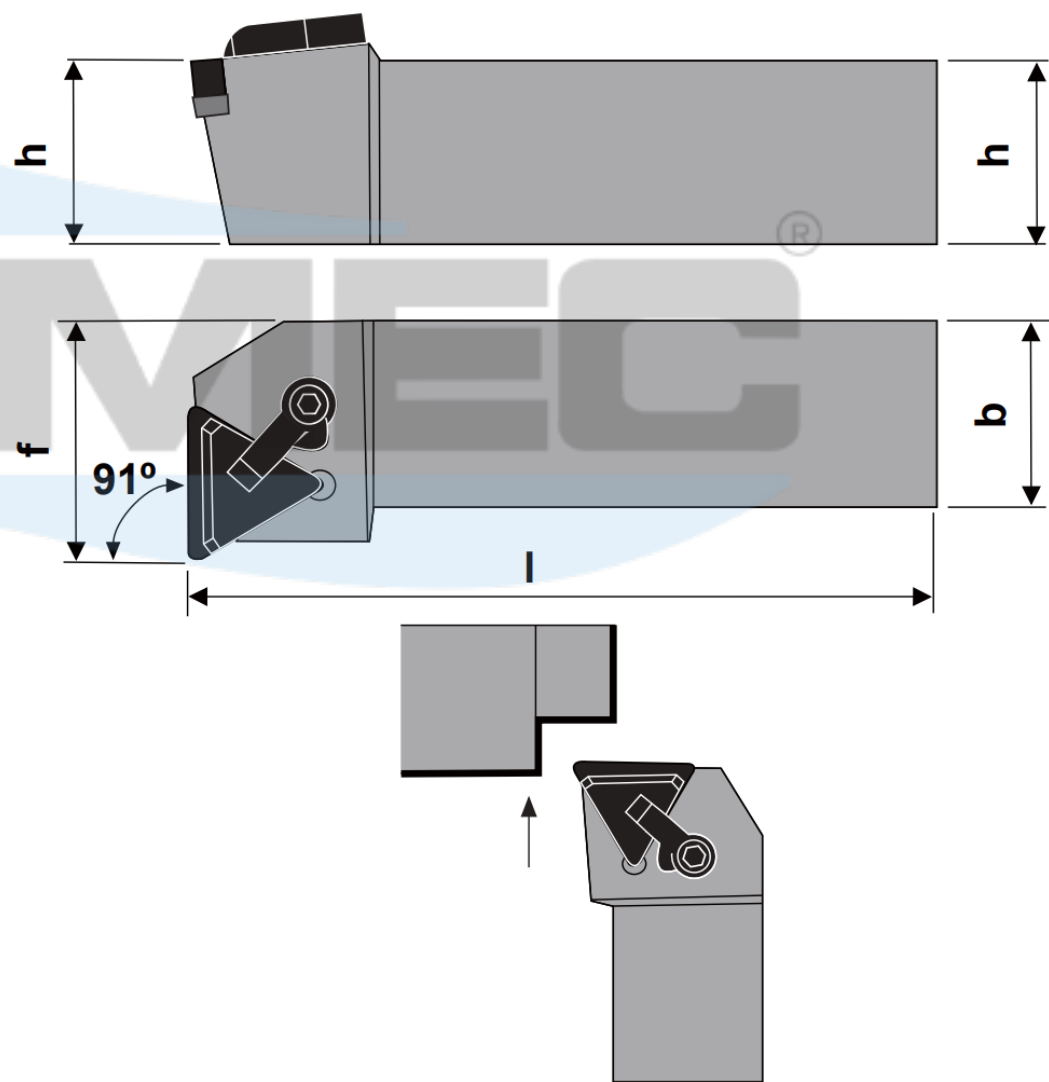
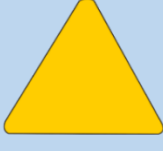
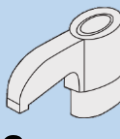
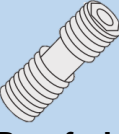
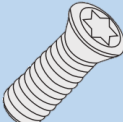

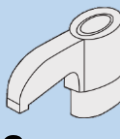
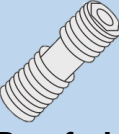
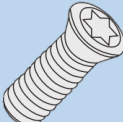





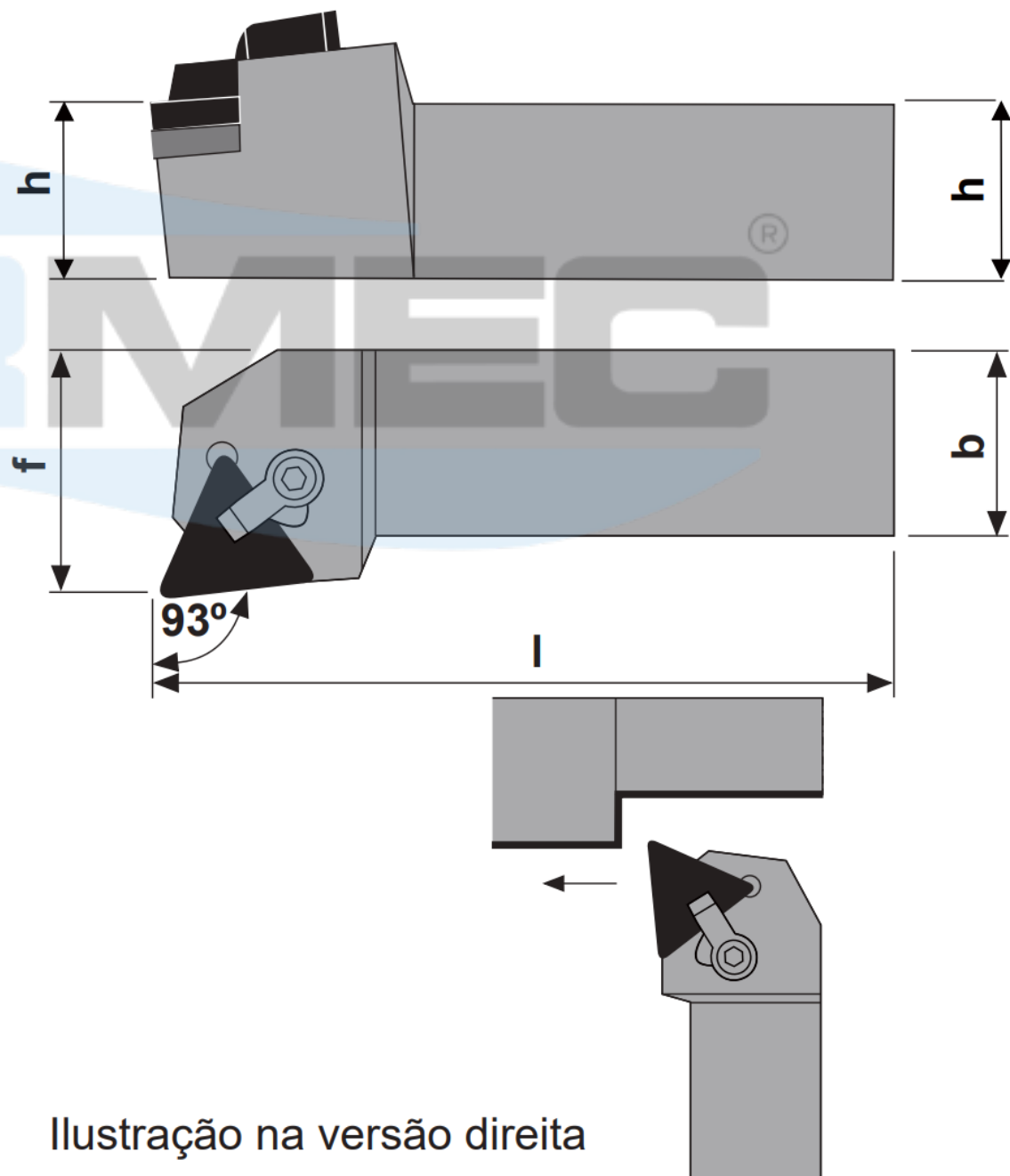
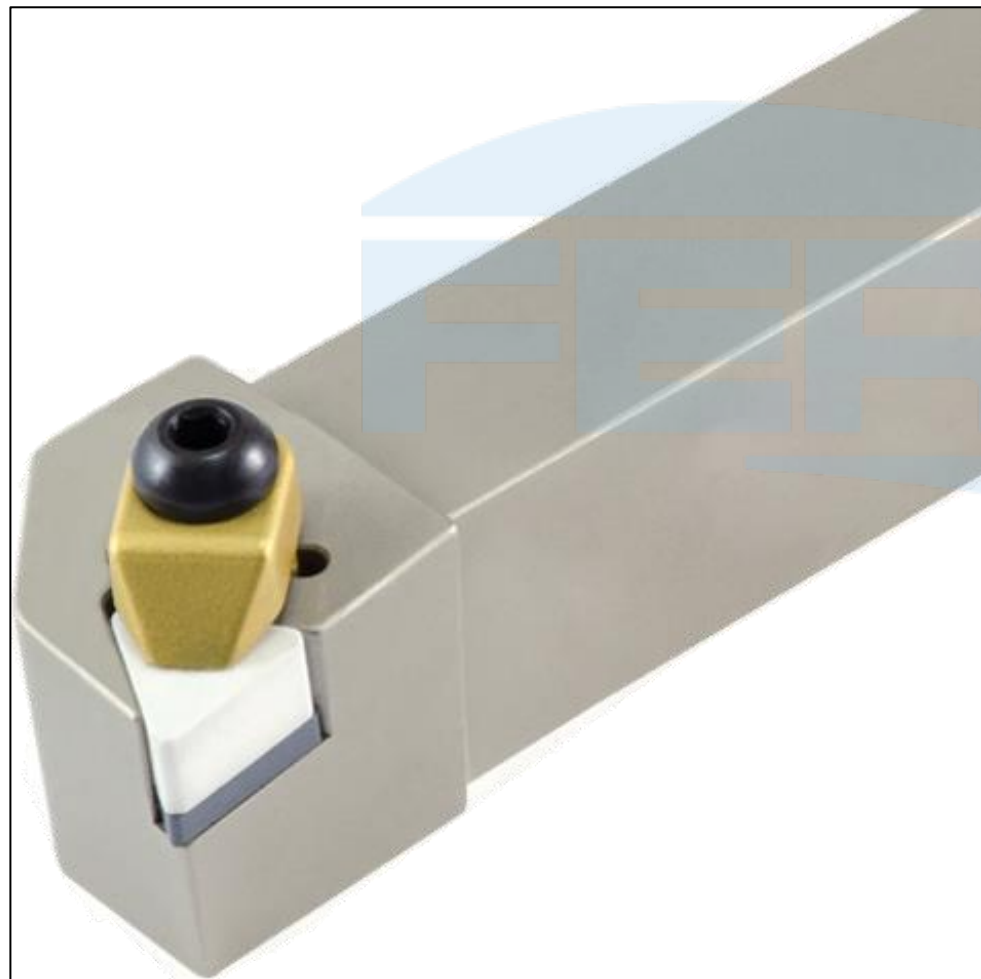

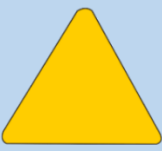

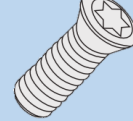
Produtos	Dimensões (mm)				Pastilha	Acessórios					
	h	b	l	f			 Grampo	 Paraf. do Grampo	 Paraf. Torx	 Calço	 Quebra-Cavaco
CTFNR/L 2020 K11-ID	20	20	125	25	TNGN 1103						
CTFNR/L 2525 M11-ID	25	25	150	32							
CTFNR/L 3225 P11-ID	32	25	170	32							

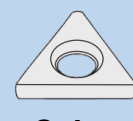
SISTEMA DE FIXAÇÃO POR GRAMPO-PARAFUSO

CTJNR

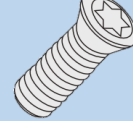
Suporte para torneiar 93° com pastilha negativa triangular

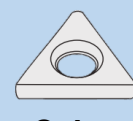

Produtos	Dimensões (mm)				Pastilha	Acessórios											
	h	b	l	f			 Grampo	 Paraf. Torx	 Paraf. do Grampo	 Calço	 Quebra-Cavaco	 Chave Torx					
CTJNR/L 2020 K11-ID	20	20	125	25	TNGN 1103												
CTJNR/L 2525 M11-ID	25	25	150	32								NC - 15	5513.020	LS 103/TX10	HTC.316-02	QCT-8N	TX 7-B TX10-F
CTJNR/L 3225 P11-ID	32	25	170	32													

SISTEMA DE FIXAÇÃO POR GRAMPO-PARAFUSO

CSBPR

Suporte para torneiar 75° com pastilha positiva quadrada



Ilustração na versão direita

Produtos	Dimensões (mm)				Pastilha	Acessórios			
	h	b	l	f		Cj. Grampo-Parafuso	Calço	Rebite	Chave Allen
CSBPR/L 1616 H09	16	16	100	13	SP_0903	174.9-830-2	-	-	C - 2,5
CSBPR/L 2020 K09	20	20	125	17					
CSBPR/L 2020 K12	20	20	125	17	SP_1203	174.9-832-2	174.2-850	174.1-865	C - 3
CSBPR/L 2525 M12	25	25	150	22					
CSBPR/L 3232 P19	32	32	170	27	SP_1904	174.9-838-1	175.2-851	174.1-866	C - 4
CSBPR/L 4040 S19	40	40	250	35					

SISTEMA DE FIXAÇÃO POR GRAMPO-PARAFUSO

CSDPN

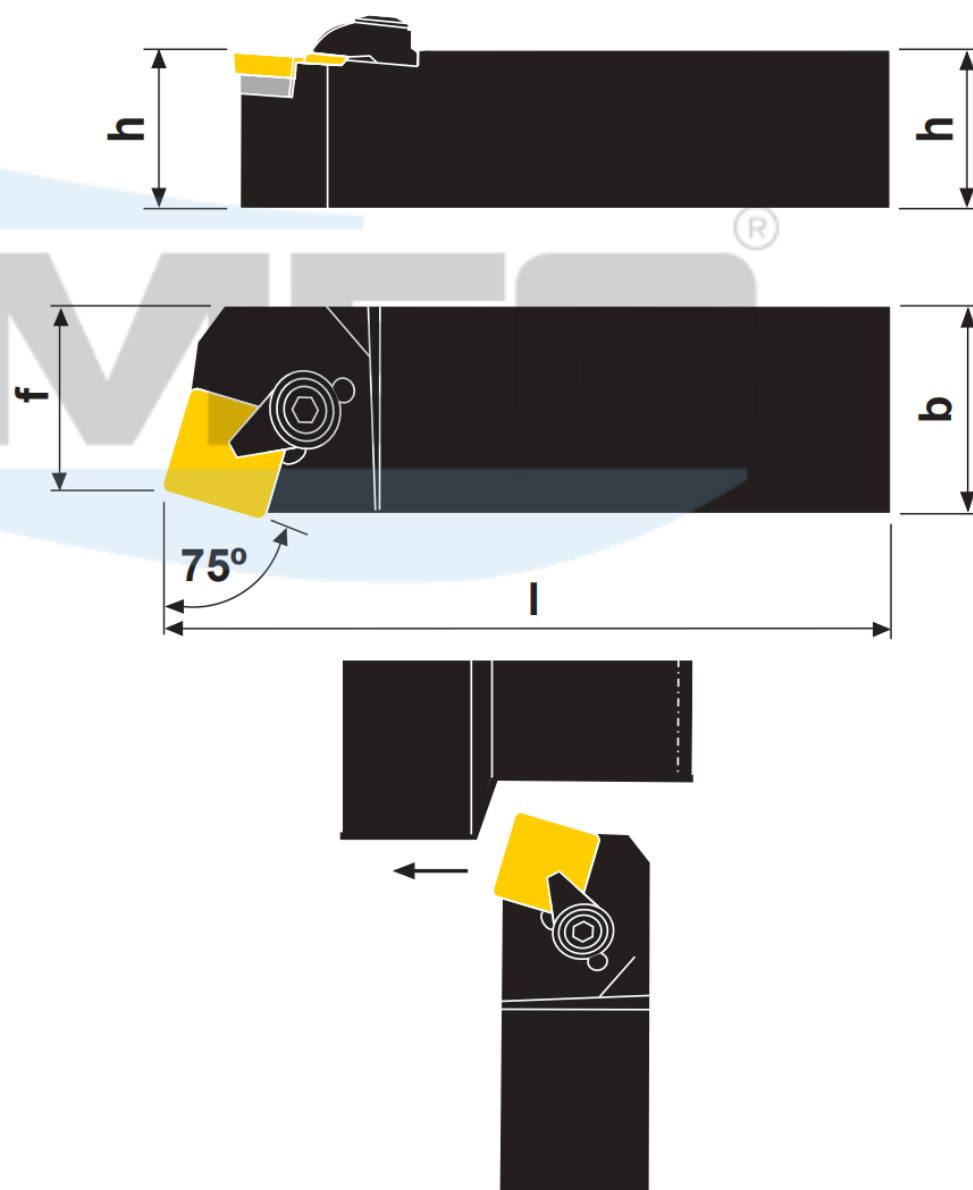
Suporte neutro para torneiar 45° com pastilha positiva quadrada



Ilustração na versão direita

Produtos	Dimensões (mm)				Pastilha	Acessórios			
	h	b	l	f		Cj. Grampo-Parafuso	Calço	Rebite	Chave Allen
CSDPN 1212 F09	12	12	80	6,3	SP_0903	174.9-830-2	-	-	C - 2,5
CSDPN 1616 H09	16	16	100	8,3					
CSDPN 2020 K12	20	20	125	10,3	SP_1203	174.9-832-2	174.2-850	174.1-865	C - 3
CSDPN 2525 M12	25	25	150	12,8					
CSDPN 3232 P19	32	32	170	16,5	SP_1904	174.9-838-1	175.2-851	174.1-866	C - 4
CSDPN 4040 S19	40	40	250	20,5					

SISTEMA DE FIXAÇÃO POR GRAMPO

CSKPR

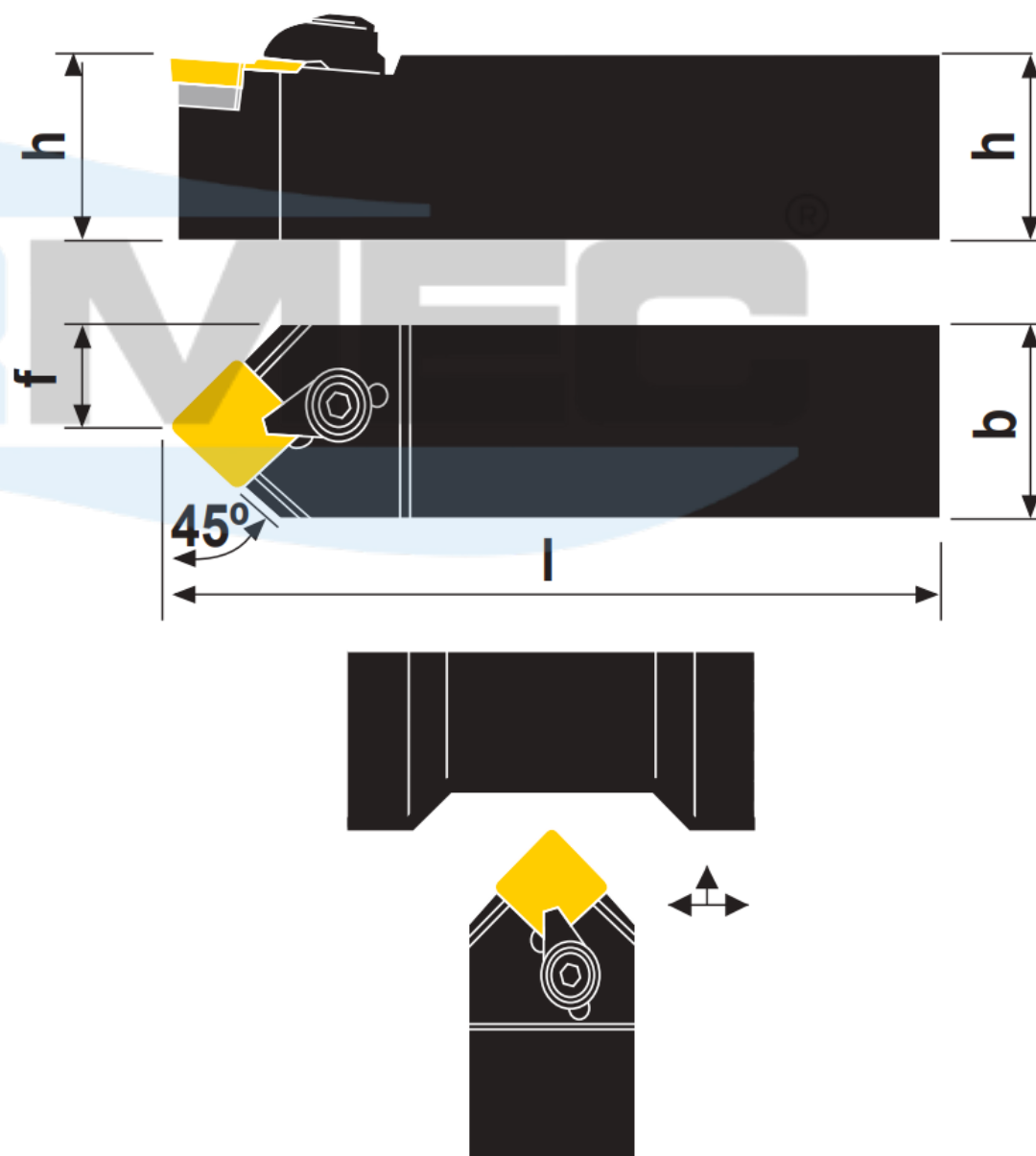
Suporte para facear 75° com pastilha positiva quadrada

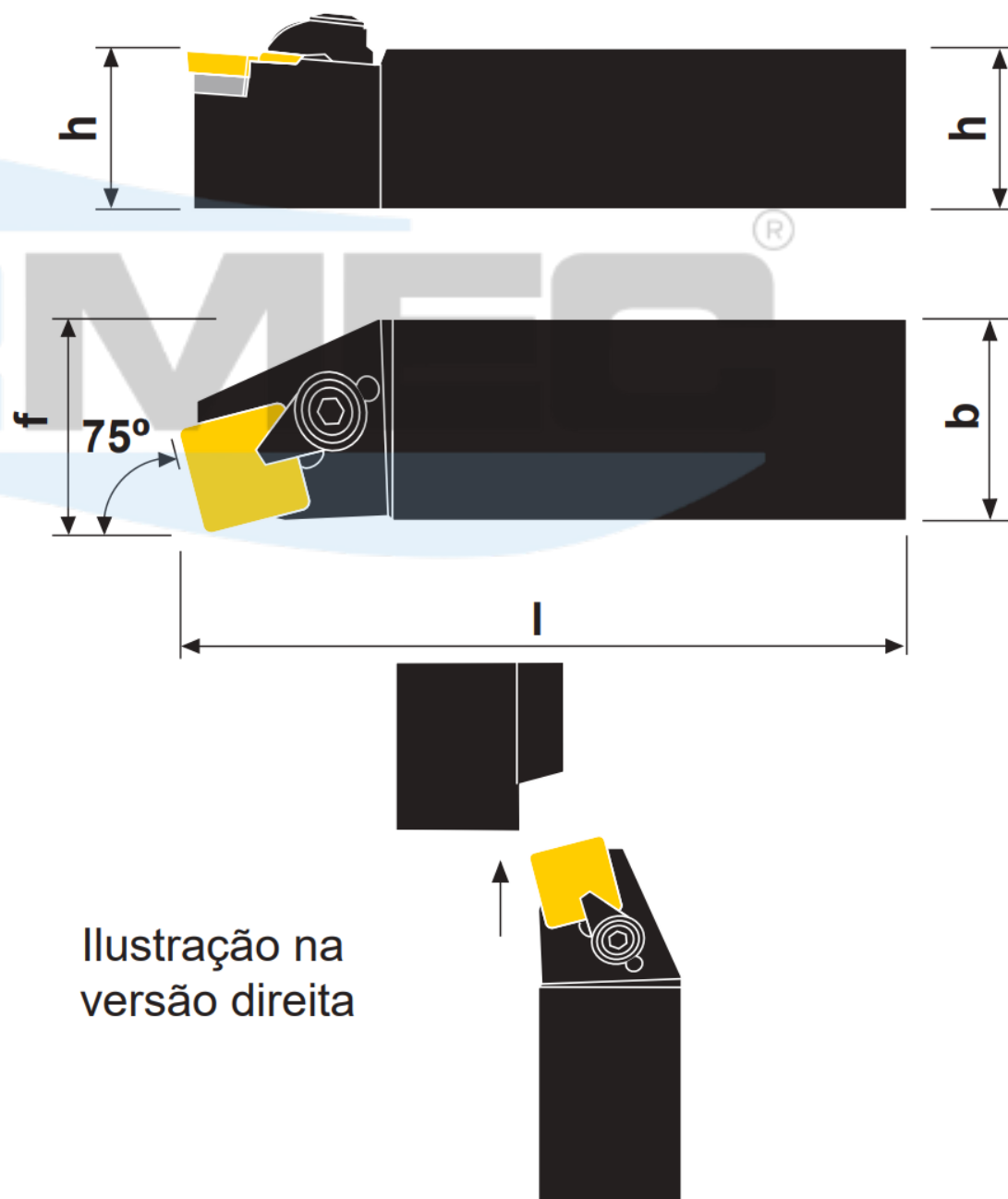

Produtos	Dimensões (mm)				Pastilha	Acessórios			
	h	b	l	f		Cj. Grampo-Parafuso	Calço	Rebite	Chave Allen
CSKPR/L 1212 F09	12	12	80	16	SP_0903	174.9-830-2	-	-	C - 2,5
CSKPR/L 1616 H09	16	16	100	20					
CSKPR/L 2020 K09	20	20	125	25					
CSKPR/L 2020 K12	20	20	125	25	SP_1203	174.9-832-2	174.2-850	174.1-865	C - 3
CSKPR/L 2525 M12	25	25	150	32					
CSKPR/L 3232 P19	32	32	170	40	SP_1904	174.9-838-1	175.2-851	174.1-866	C - 4

SISTEMA DE FIXAÇÃO POR GRAMPO

CSSPR

Suporte para torneiar e facear 45° com pastilha positiva quadrada



Ilustração na versão direita

Produtos	Dimensões (mm)				Pastilha	Acessórios			
	h	b	l	f		Cj. Grampo-Parafuso	Calço	Rebite	Chave Allen
CSSPR/L 1212 F09	12	12	80	16	SP_0903	174.9-830-2	-	-	C - 2,5
CSSPR/L 1616 H09	16	16	100	20					
CSSPR/L 2020 K09	20	20	125	25					
CSSPR/L 2020 K12	20	20	125	25	SP_1203	174.9-832-2	174.2-850	174.1-865	C - 3
CSSPR/L 2525 M12	25	25	150	32					
CSSPR/L 3232 P19	32	32	170	40					

SISTEMA DE FIXAÇÃO POR GRAMPO-PARAFUSO

CTCPN

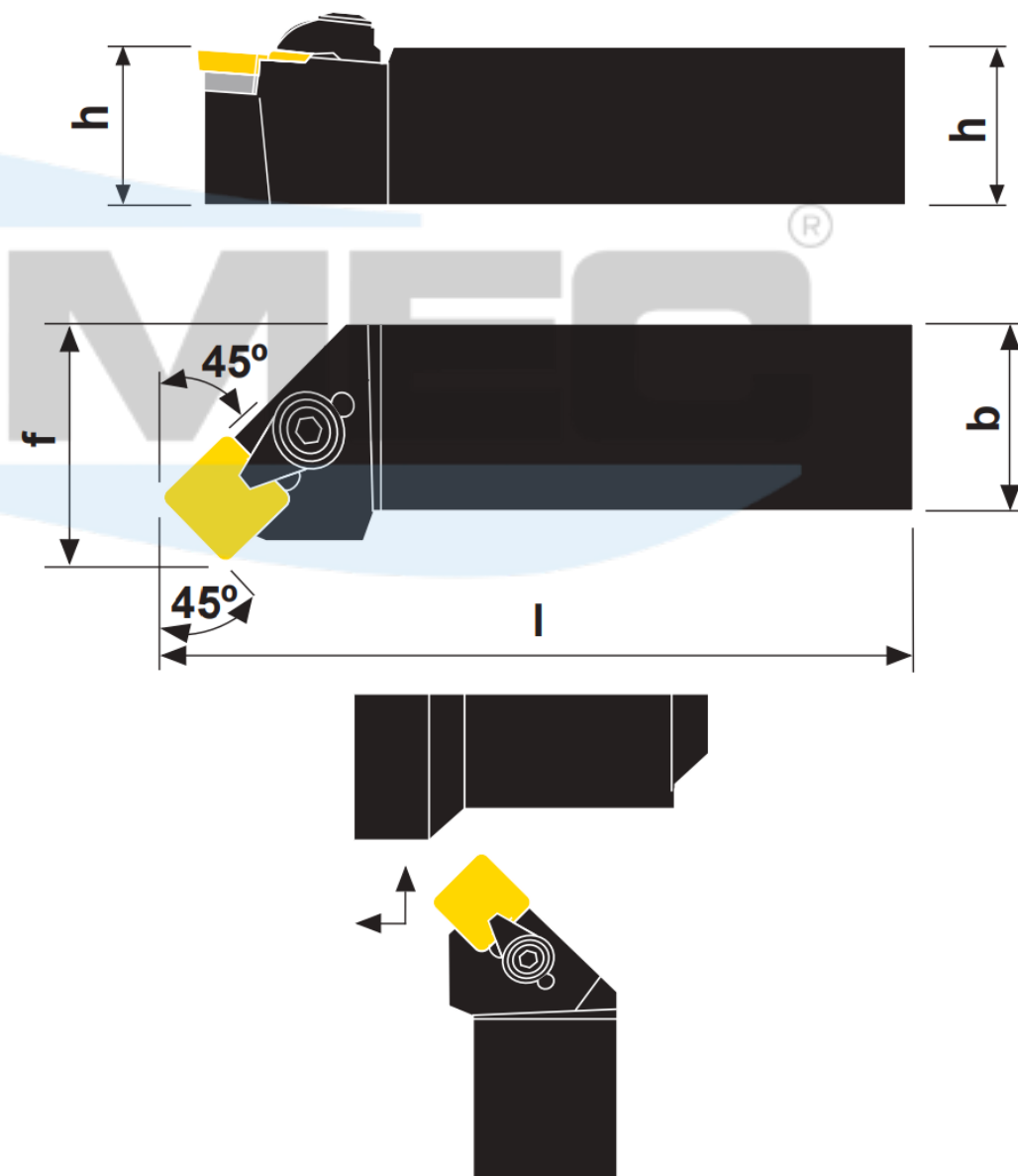
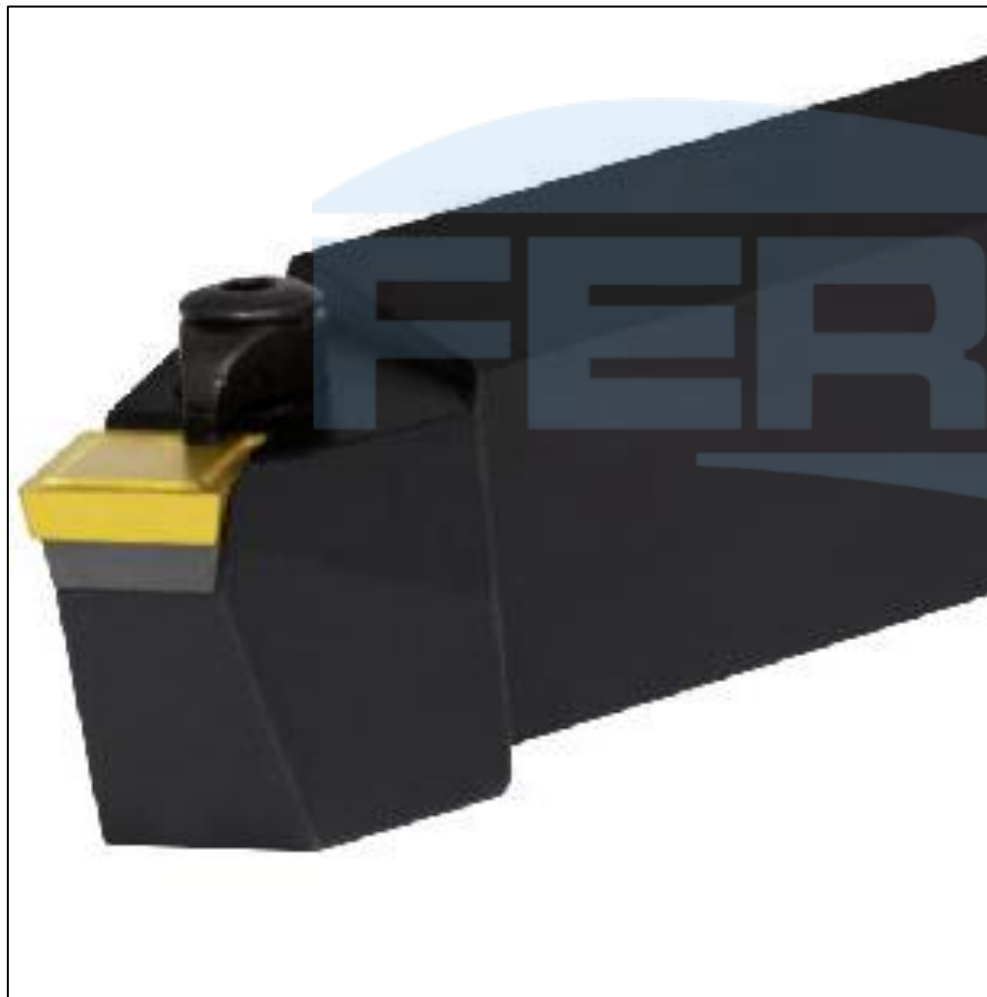
Suporte neutro para facear 90° com pastilha positiva triangular



Ilustração na versão direita

Produtos	Dimensões (mm)				Pastilha	Acessórios			
	h	b	l	f		Cj. Grampo-Parafuso	Calço	Rebite	Chave Allen
CTCPN 2510 M11	25	10	150	9,4	TP_1103	174.9-830-2	-	-	C - 2,5
CTCPN 2514 M16	25	14	150	14,1	TP_1603	174.9-832-2	175.5-850	174.1-865	C - 3

SISTEMA DE FIXAÇÃO POR GRAMPO-PARAFUSO

CTDPR

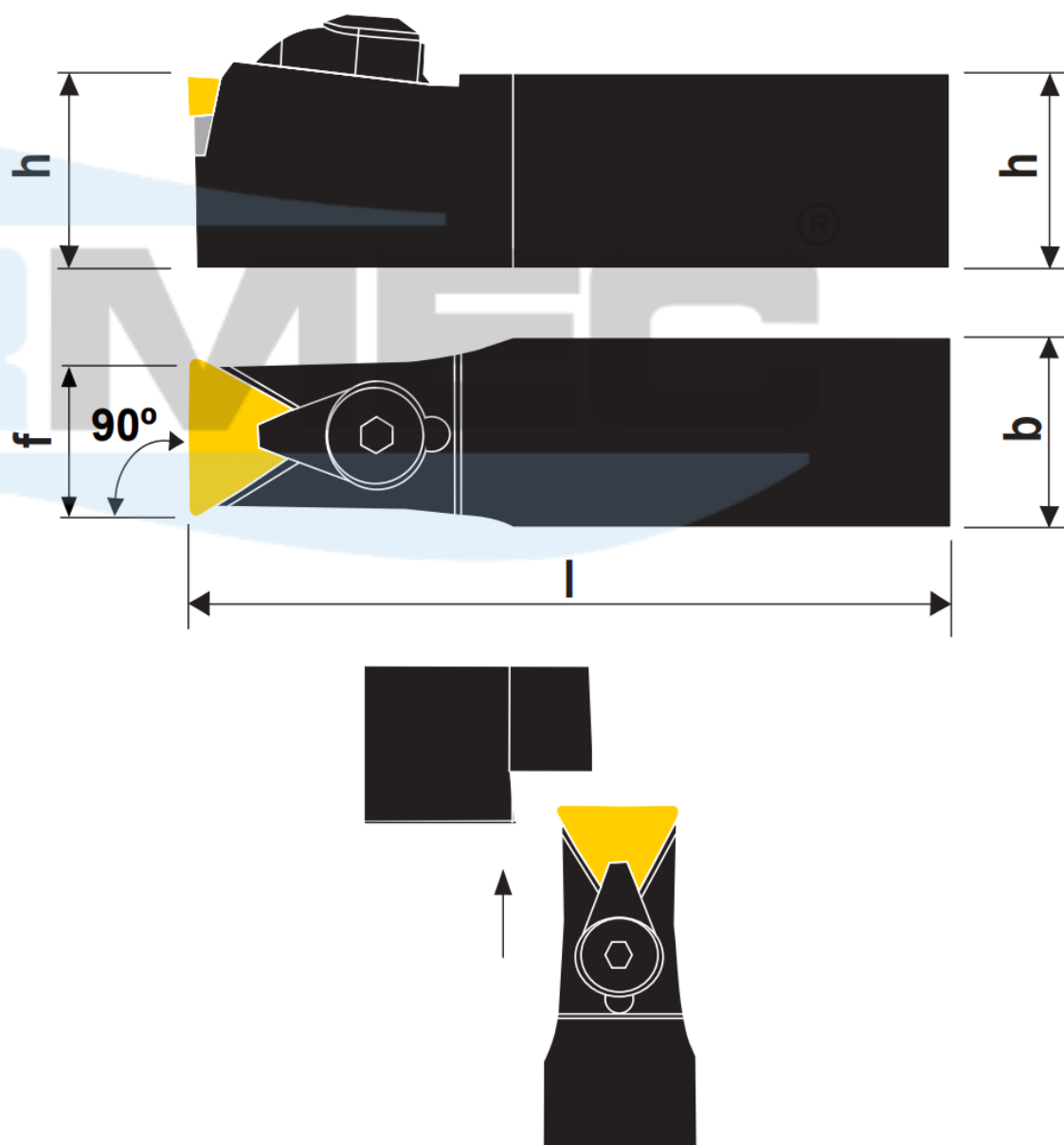
Suporte para facear 45° com pastilha positiva triangular



Ilustração na versão direita

Produtos	Dimensões (mm)				Pastilha	Acessórios			
	h	b	l	f		 Cj. Grampo-Parafuso	 Calço	 Rebite	 Chave Allen
CTDPR/L 1212 F11	12	12	80	13	TP_1103	174.9-830-2	-	-	C - 2,5
CTDPR/L 1616 H11	16	16	100	17					
CTDPR/L 2020 K16	20	20	125	22	TP_1603	174.9-832-2	175.2-850	174.1-865	C - 3
CTDPR/L 2525 M16	25	25	150	27					

SISTEMA DE FIXAÇÃO POR GRAMPO-PARAFUSO

CTFPR

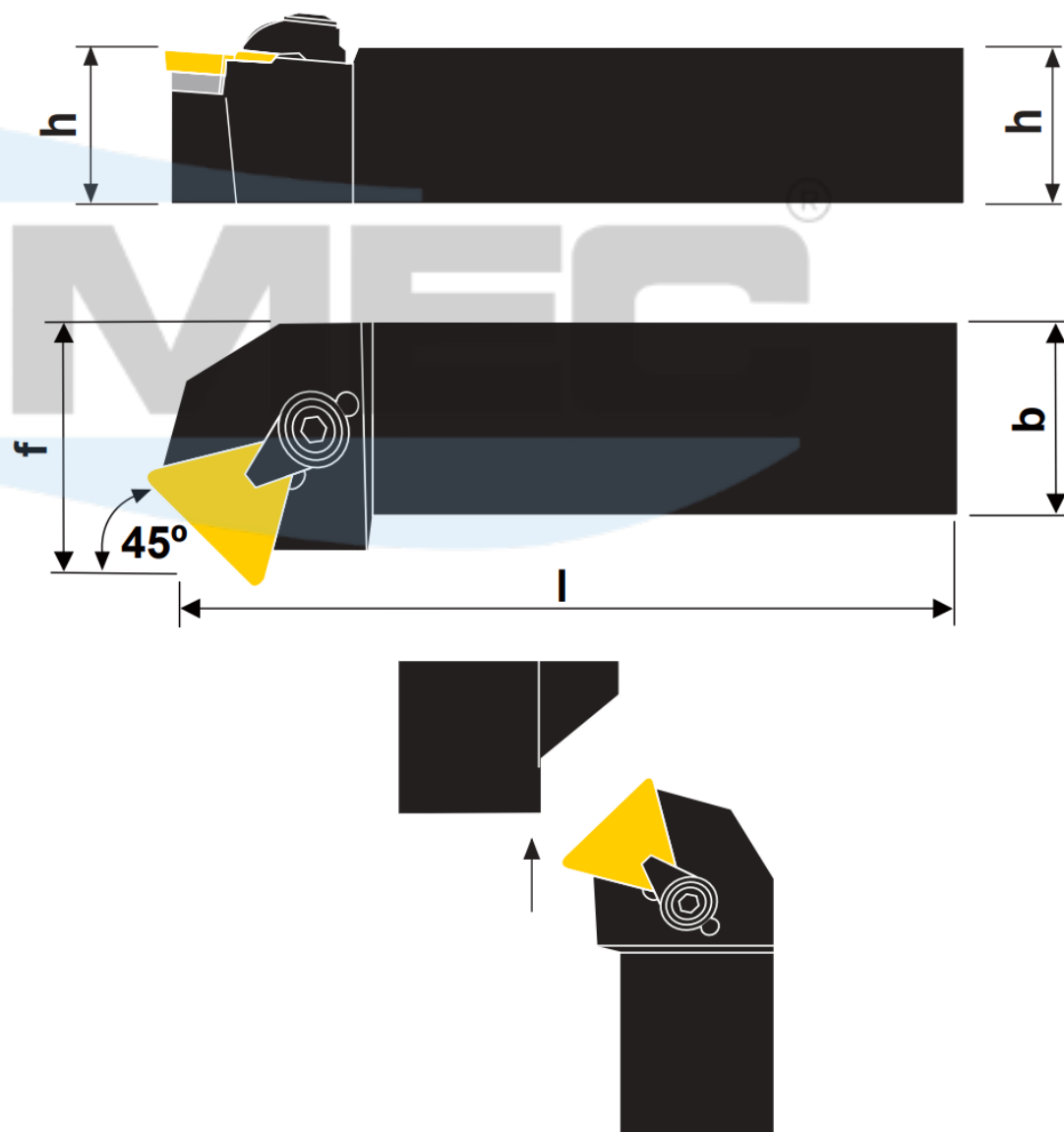
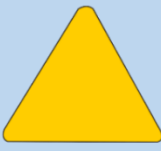
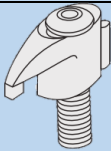
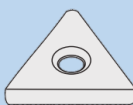
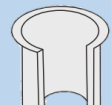
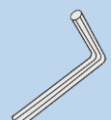
Suporte para facear 91° com pastilha positiva triangular



Ilustração na versão direita

Produtos	Dimensões (mm)				Pastilha	Acessórios			
	h	b	l	f		 Cj. Grampo-Parafuso	 Calço	 Rebite	 Chave Allen
CTFPR/L 0808 D09	08	08	60	10	TP_0902	172.9-825-1	-	-	C - 1,5
CTFPR/L 1010 E09	10	10	70	12					
CTFPR/L 1212 F11	12	12	80	16	TP_1103	174.9-830-2	-	-	C - 2,5
CTFPR/L 1616 H11	16	16	100	20					
CTFPR/L 2020 K11	20	20	125	25					
CTFPR/L 2020 K16	20	20	125	25	TP_1603	174.9-832-2	175.2-850	174.1-865	C - 3
CTFPR/L 2525 M16	25	25	150	32					
CTFPR/L 2525 M22	25	25	150	32	TP_2204	174.9-838-1	175.2-851	174.1-866	C - 4
CTFPR/L 3232 P22	32	32	170	40					

SISTEMA DE FIXAÇÃO POR GRAMPO-PARAFUSO

CTGPR

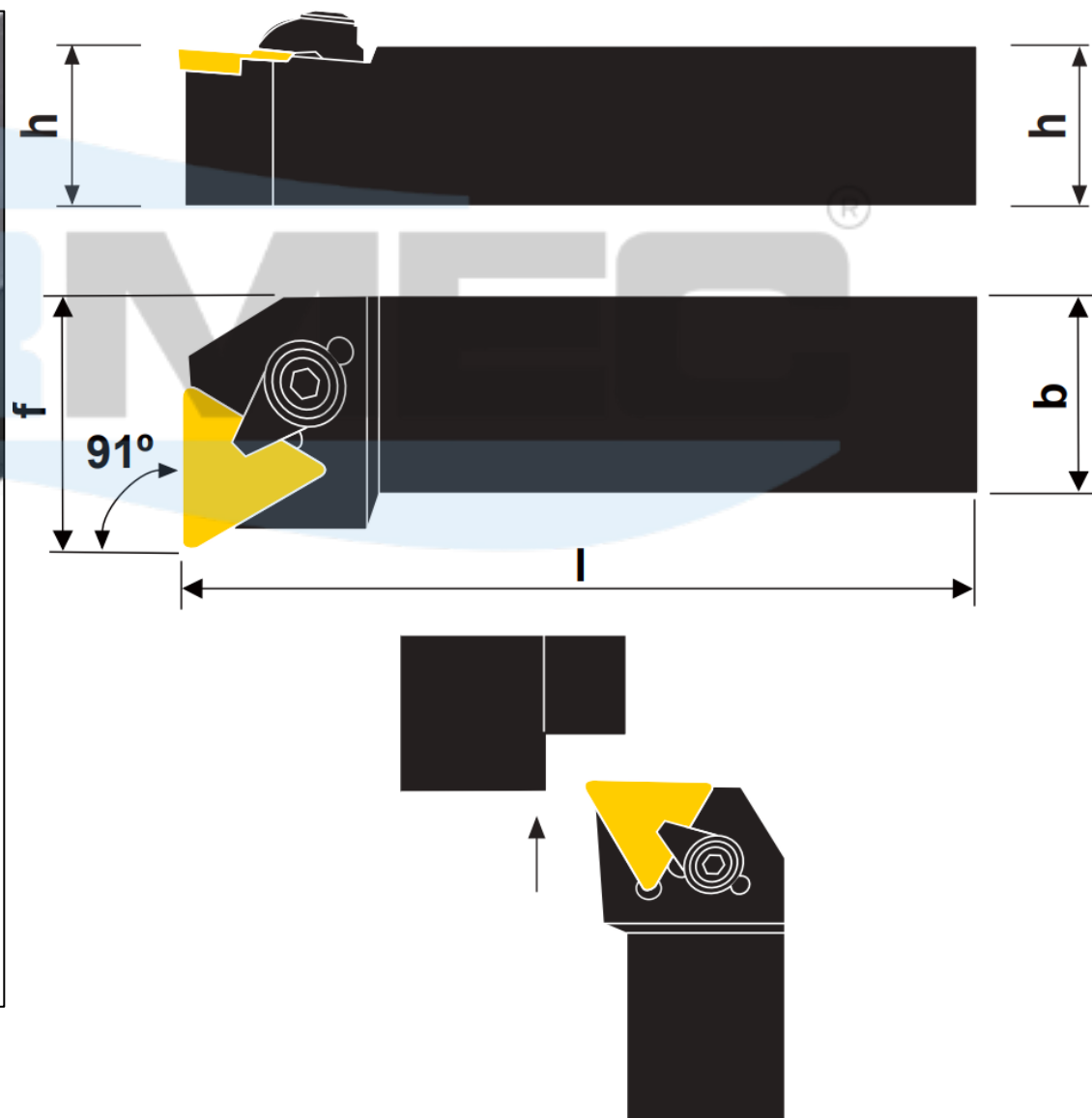
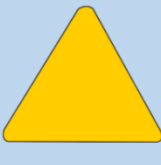
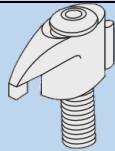
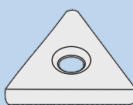
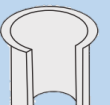
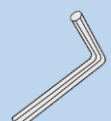
Suporte para torneiar 91° com pastilha positiva triangular







Ilustração na versão direita

Produtos	Dimensões (mm)				Pastilha	Acessórios			
	h	b	l	f			 Cj. Grampo-Parafuso	 Calço	 Rebite
CTGPR/L 0808 D09	08	08	60	10	TP_0902		-	-	C - 1,5
CTGPR/L 1010 E09	10	10	70	12					
CTGPR/L 1212 F11	12	12	80	16	TP_1103		-	-	C - 2,5
CTGPR/L 1616 H11	16	16	100	20					
CTGPR/L 2020 K11	20	20	125	25					
CTGPR/L 2020 K16	20	20	125	25	TP_1603		175.2-850	174.1-865	C - 3
CTGPR/L 2525 M16	25	25	150	32					
CTGPR/L 2525 M22	25	25	150	32	TP_2204		175.2-851	174.1-866	C - 4
CTGPR/L 3232 P22	32	32	170	40					

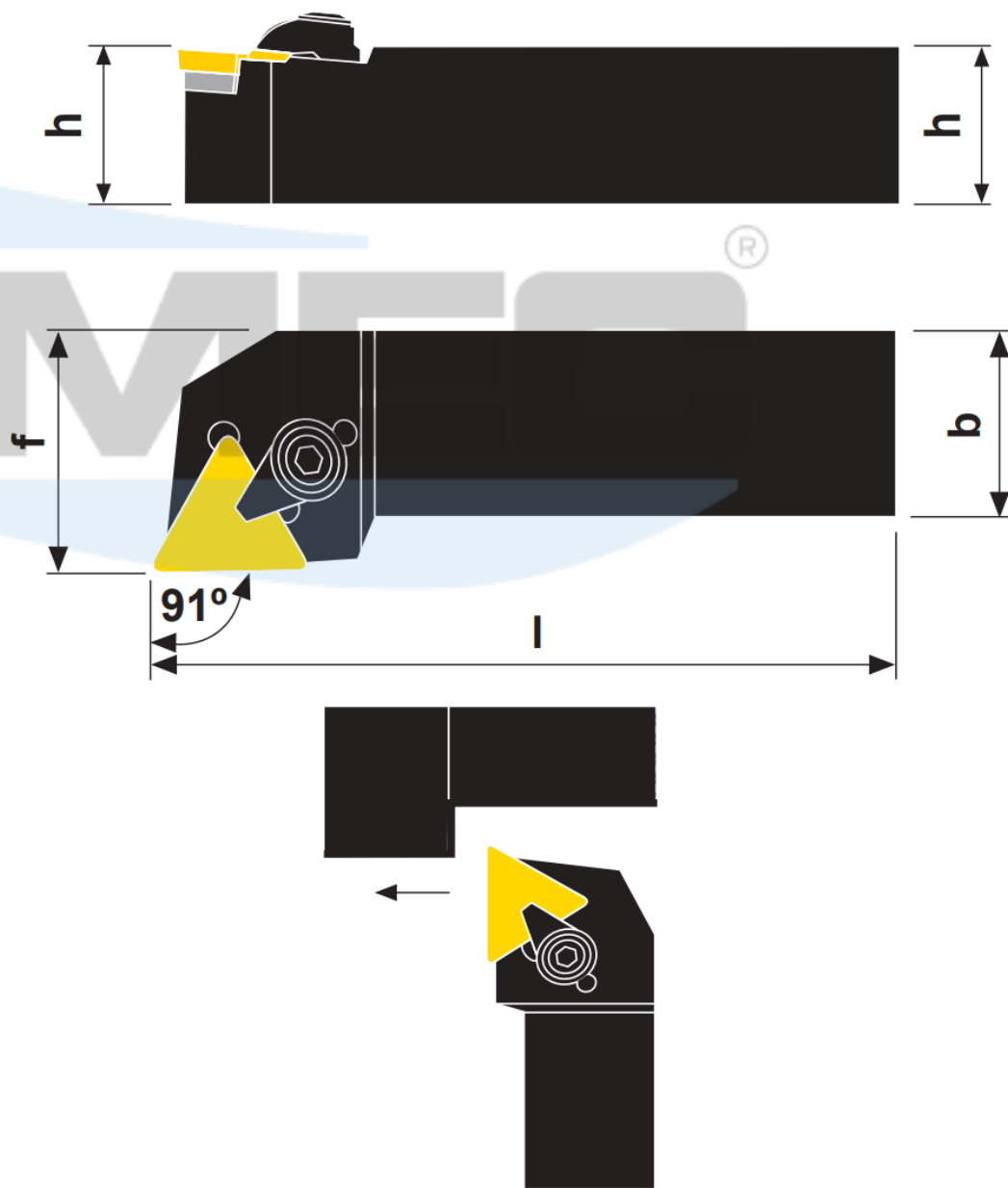
SISTEMA DE FIXAÇÃO POR GRAMPO-PARAFUSO

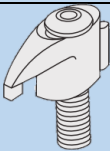
CTTPR

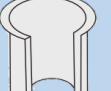
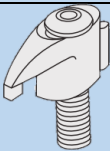
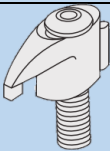
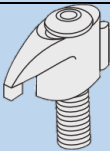
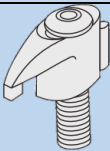
Suporte para torneiar 60° com pastilha positiva triangular





Ilustração na versão direita

Produtos	Dimensões (mm)				Pastilha	Acessórios			
	h	b	l	f		 Cj. Grampo-Parafuso	 Calço	 Rebite	 Chave Allen
CTTPR/L 1212 F11	12	12	80	9	TP_1103	174.9-830-2	-	-	C - 2,5
CTTPR/L 1616 H11	16	16	100	13					
CTTPR/L 2020 K11	20	20	125	17					
CTTPR/L 2020 K16	20	20	125	17	TP_1603	174.9-832-2	175.2-850	174.1-865	C - 3
CTTPR/L 2525 M16	25	25	150	22					
CTTPR/L 3232 P16	32	32	170	27					
CTTPR/L 3232 P22	32	32	170	27	TP_2204	174.9-838-1	175.2-851	174.1-866	C - 4

SISTEMA DE FIXAÇÃO POR GRAMPO-PARAFUSO

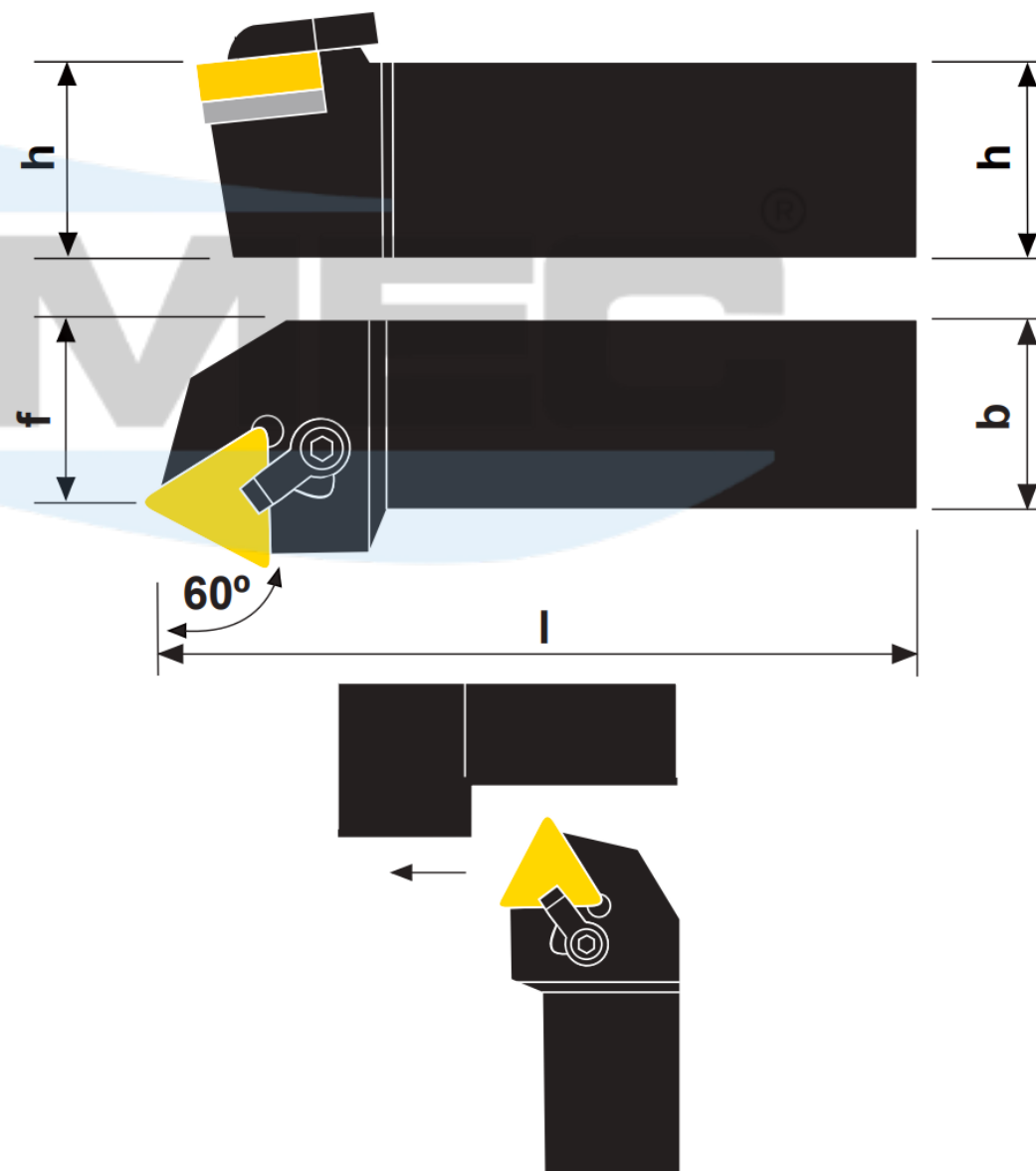
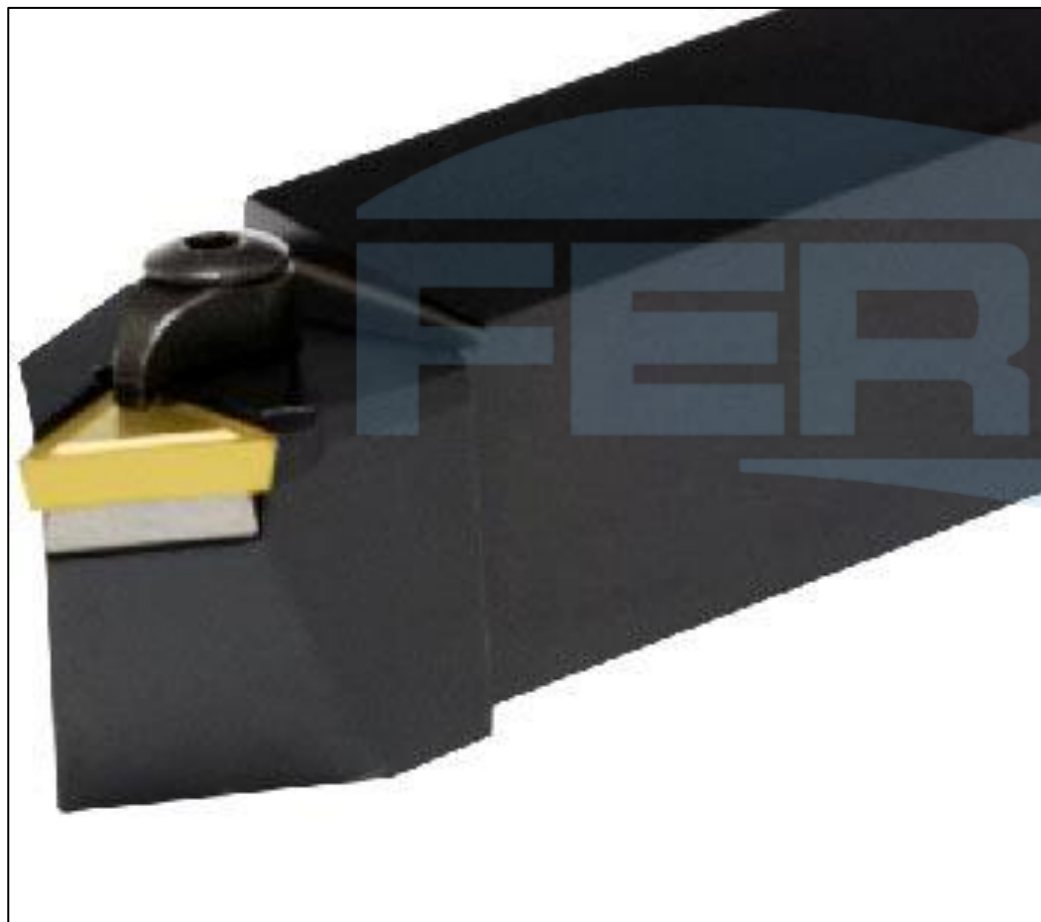
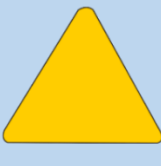
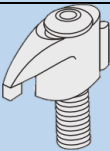
CKJNR

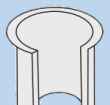
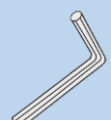
Suporte para torneiar 93° com pastilha positiva 55°









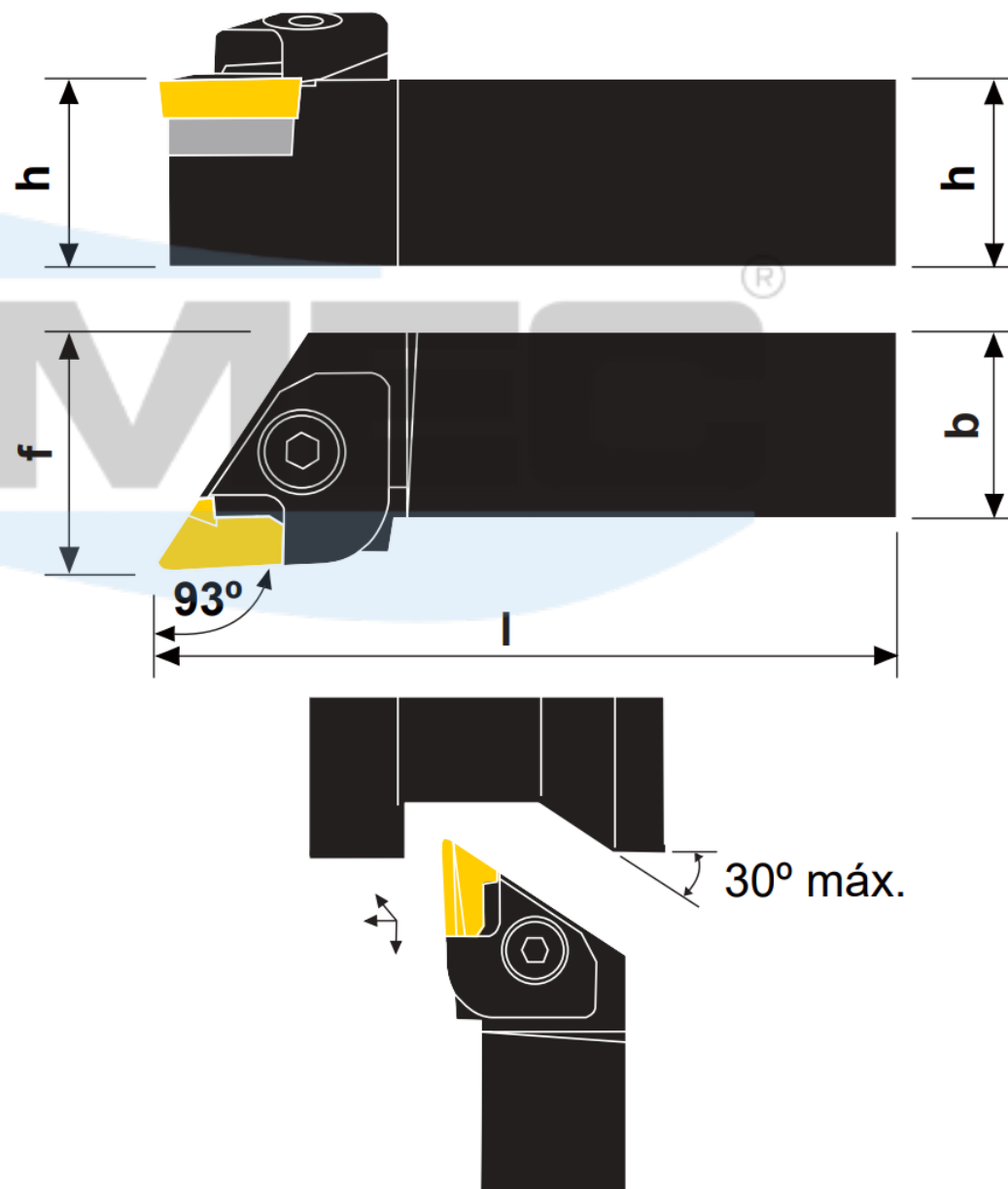

Ilustração na versão direita





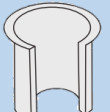



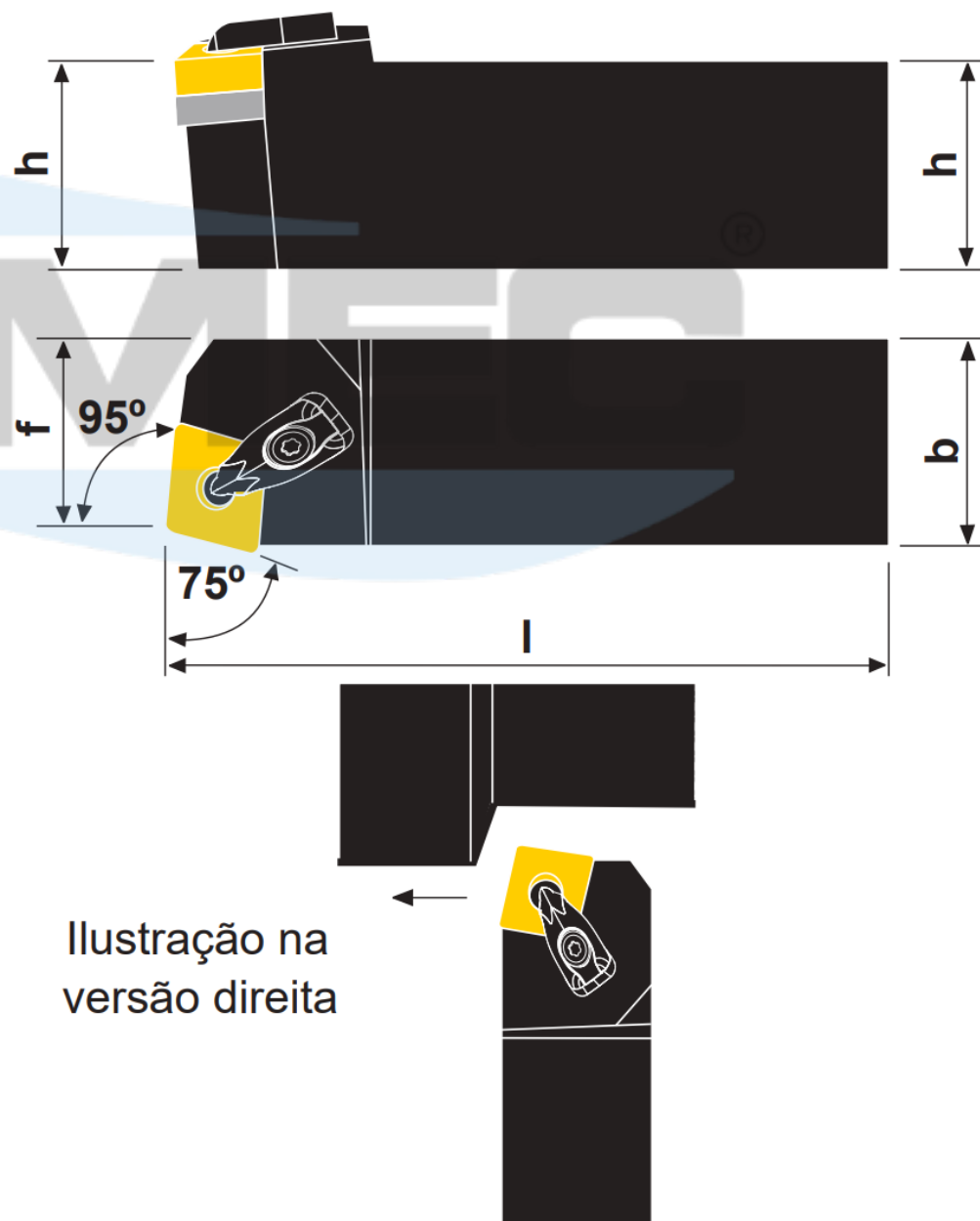



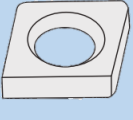

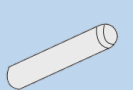



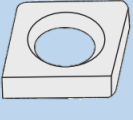

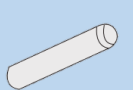



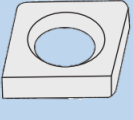

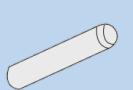

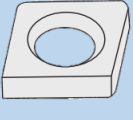

Produtos	Dimensões (mm)				Pastilha	Acessórios						
	h	b	l	f		Grampo	Paraf. do Grampo	Mola	Pino c/ mola	Calço	Rebite	Chave Allen
CKJNR/L 2020 K16	20	20	125	25	 KNUX 1604_ER KNUX 1604_EL	 170.5-824 170.5-825	 170.5-865	 170.5-848M	 170.5-841	 R170.5-5.851 L170.5-851	 174.1-866	 C - 4
CKJNR/L 2525 M16	25	25	150	32								
CKJNR/L 3225 P16	32	25	170	32								
CKJNR/L 3232 P16	32	32	170	40								

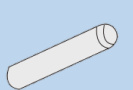
SISTEMA DE FIXAÇÃO RÍGIDA

DCBNR

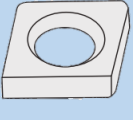
Suporte para tornear 75° com pastilha negativa de 80° para aproveitamento do ângulo de 100°

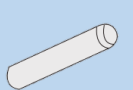









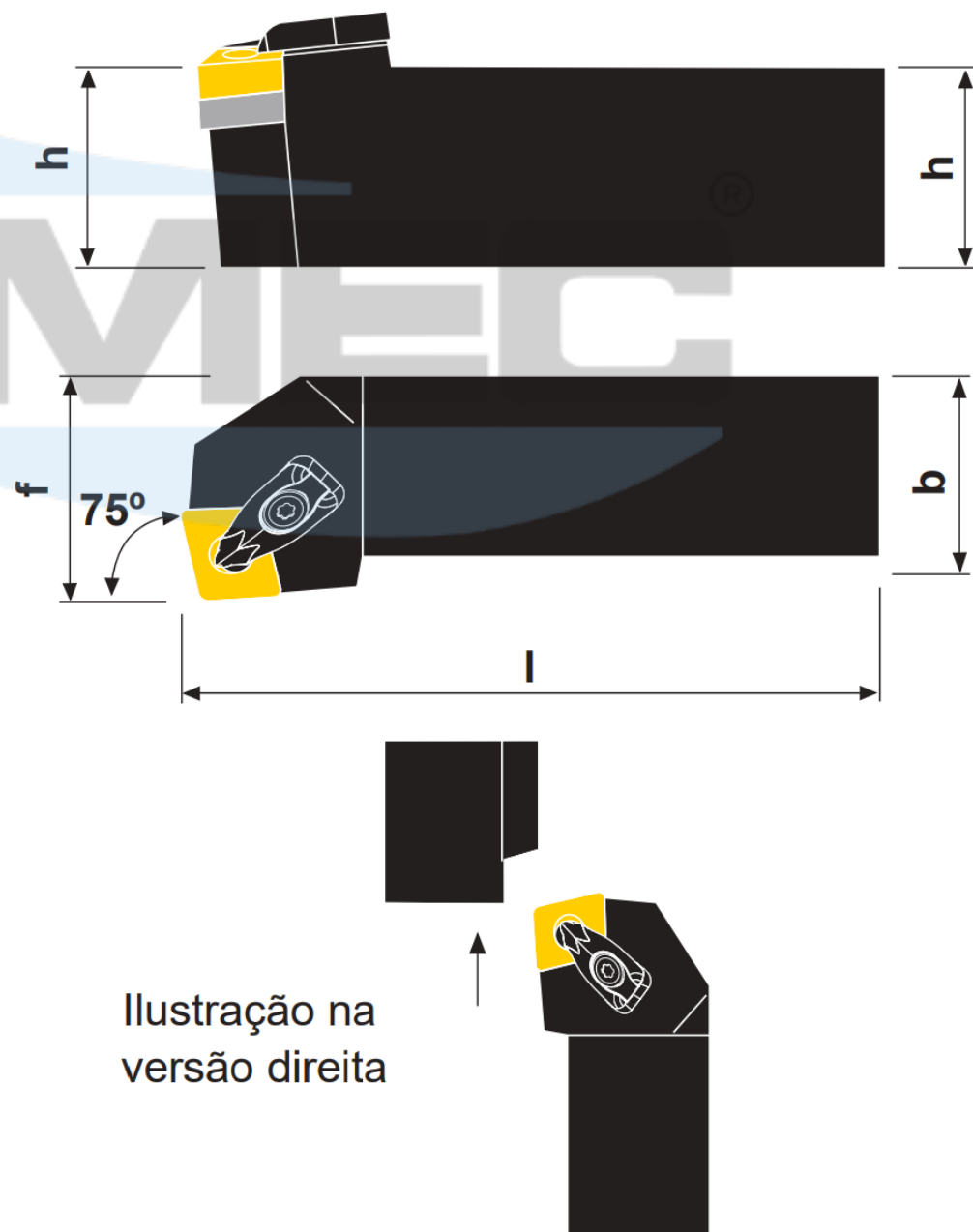





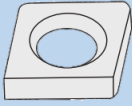



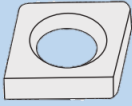

Produtos	Dimensões (mm)				Pastilha	Acessórios						
	h	b	l	f								
						Grampo	Paraf. do Grampo	Calço	Paraf. do Calço	Pino	Mola	Chave Torx
DCBNR/L 1616 H09	16	16	100	13	CN_0903							
DCBNR/L 2020 K09	20	20	125	17								
DCBNR/L 2525 M09	25	25	150	22								
DCBNR/L 2020 K12	20	20	125	17	CN_1204							
DCBNR/L 2525 M12	25	25	150	22								
DCBNR/L 3225 P12	32	25	170	22								
DCBNR/L 2525 M16	25	25	150	22	CN_1606							
DCBNR/L 3232 P16	32	32	170	27								
DCBNR/L 3232 P19	32	32	170	27	CN_1906							
DCBNR/L 4040 S19	40	40	250	35								
DCBNR/L 5050 T19	50	50	300	43								

SISTEMA DE FIXAÇÃO RÍGIDA

DCKNR

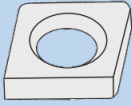
Suporte para facear 75° com pastilha negativa de 80° para aproveitamento de 100°



Produtos	Dimensões (mm)				Pastilha	Acessórios						
	h	b	l	f								
DCKNR/L 1616 H09	16	16	100	20	CN_0903							
DCKNR/L 2020 K09	20	20	125	25								
DCKNR/L 2525 M09	25	25	150	32								
DCKNR/L 2020 K12	20	20	125	25	CN_1204							
DCKNR/L 2525 M12	25	25	150	32								
DCKNR/L 3225 P12	32	25	170	32								
DCKNR/L 3232 P19	32	32	170	40								

SISTEMA DE FIXAÇÃO POR ALAVANCA

DCLNR

Suporte para torneiar e facear 95° com pastilha negativa de 80°











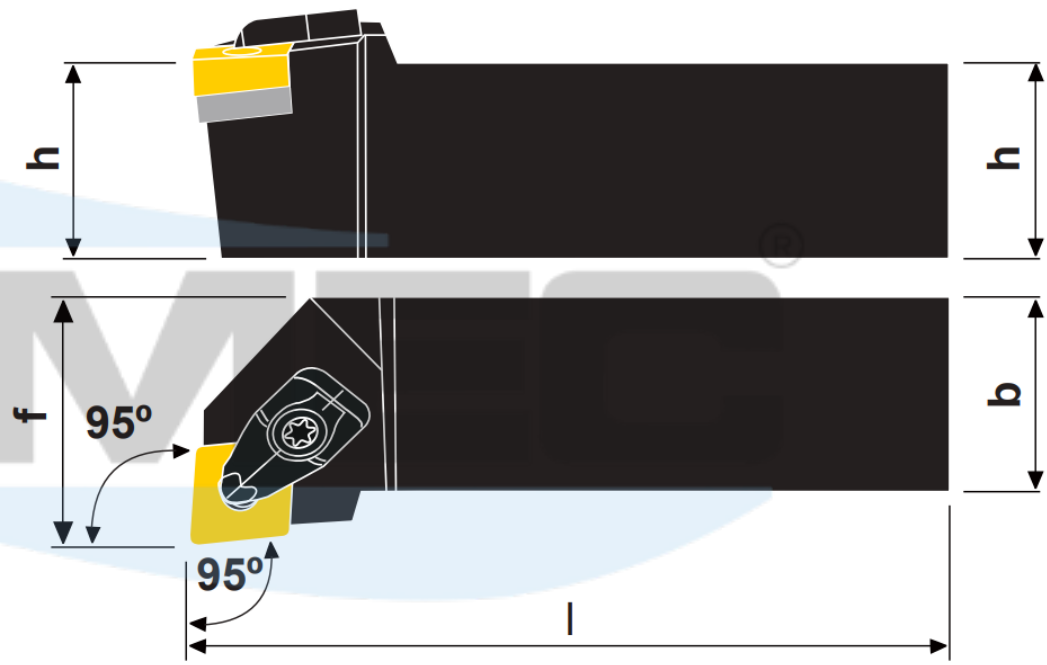
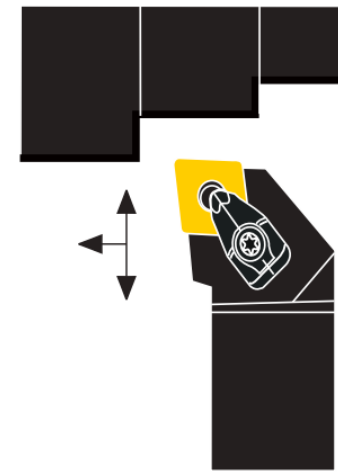



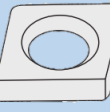

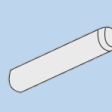



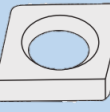

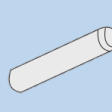



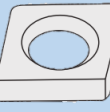

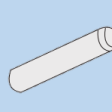



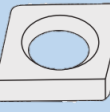

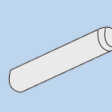
Ilustração na versão direita

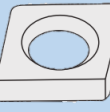

Produtos	Dimensões (mm)				Pastilha 	Acessórios						
	h	b	l	f		 Grampo	 Paraf. do Grampo	 Calço	 Paraf. do Calço	 Pino	 Mola	 Chave Torx
DCLNR/L 1616 H09	16	16	100	20	CN_0903							
DCLNR/L 2020 K09	20	20	125	25								
DCLNR/L 2525 M09	25	25	150	32								
DCLNR/L 2020 K12	20	20	125	25	CN_1204							
DCLNR/L 2525 M12	25	25	150	32								
DCLNR/L 3225 P12	32	25	170	32								
DCLNR/L 4040 S12	40	40	250	50	CN_1606							
DCLNR/L 2525 M16	25	25	150	32								
DCLNR/L 3225 P16	32	25	170	32								
DCLNR/L 3232 P16	32	32	170	40	CN_1906							
DCLNR/L 3232 P19	32	32	170	40								
DCLNR/L 4040 S19	40	40	250	50								

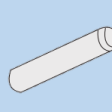
SISTEMA DE FIXAÇÃO POR ALAVANCA

DCSNR

Suporte para tornear 45° com pastilha negativa de 80°











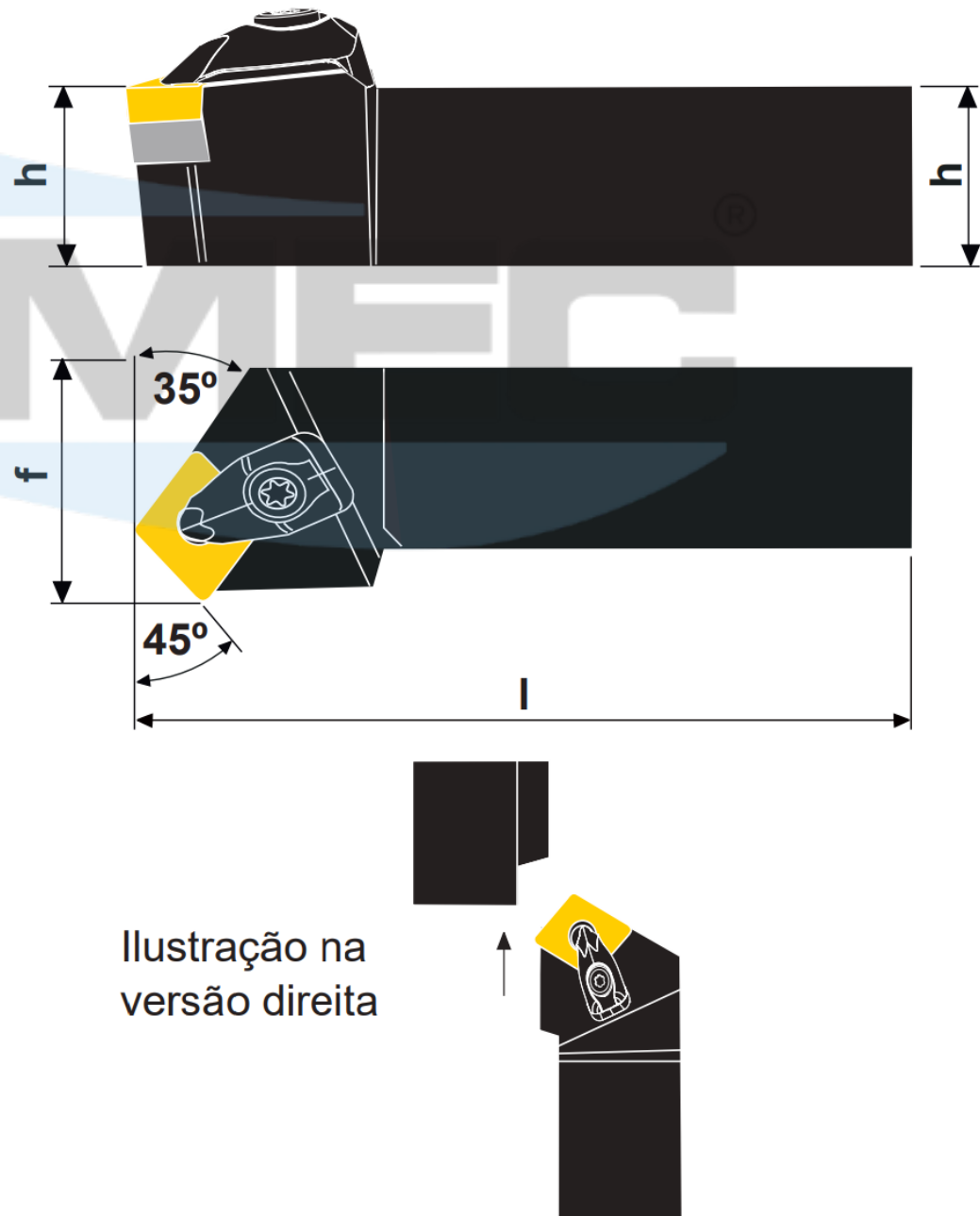







Ilustração na versão direita









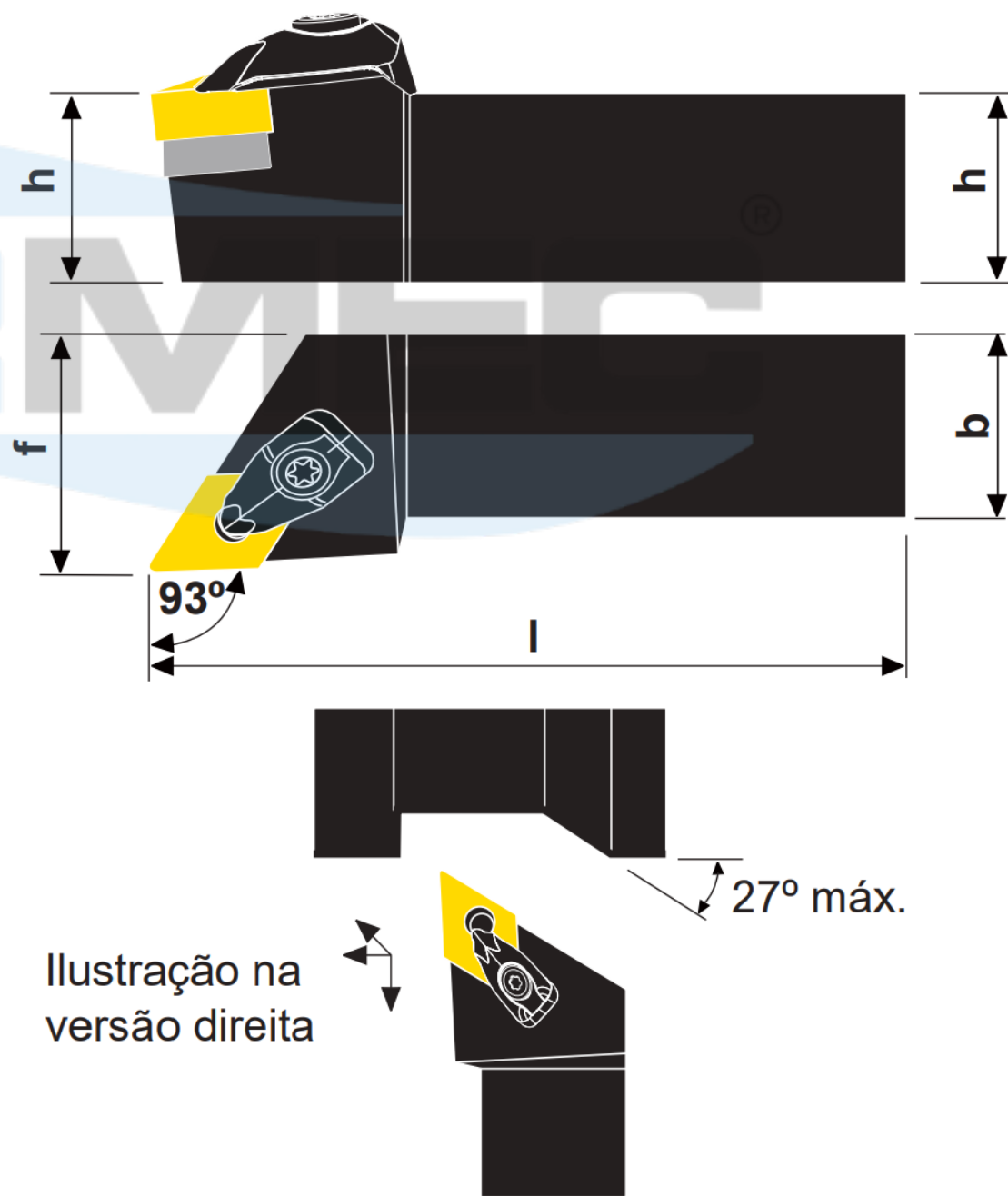



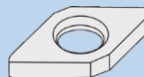



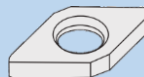

Produtos	Dimensões (mm)				Pastilha	Acessórios													
	h	b	l	f			 Grampo	 Paraf. do Grampo	 Calço	 Paraf. do Calço	 Pino	 Mola	 Chave Torx						
DCSNR/L 2020 K12	20	20	125	25	CN_1204														
DCSNR/L 2525 M12	25	25	150	32									5412 028-02	5412 086-02	5322 234-01	5513 020-02	5412 030-307	5412 001-58	T15-
DCSNR/L 3225 P23	32	25	170	32															

SISTEMA DE FIXAÇÃO POR GRAMPO-PARAFUSO

DDJNR

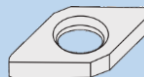
Suporte para torneiar 93° com pastilha negativa de 55°



Produtos	Dimensões (mm)				Pastilha	Acessórios						
	h	b	l	f								
DDJNR/L 2020 K11	20	20	125	25	DN_1104							
DDJNR/L 2525 M11	25	25	150	32								
DDJNR/L 3225 P11	32	25	170	32								
DDJNR/L 2020 K15	20	20	125	25	DN_1506							
DDJNR/L 2525 M15	25	25	150	32								
DDJNR/L 3232 P15	32	32	170	40								

SISTEMA DE FIXAÇÃO POR GRAMPO-PARAFUSO

DDHNR

Suporte para torneiar e facear $107^{\circ}30'$ com pastilha negativa de 55°









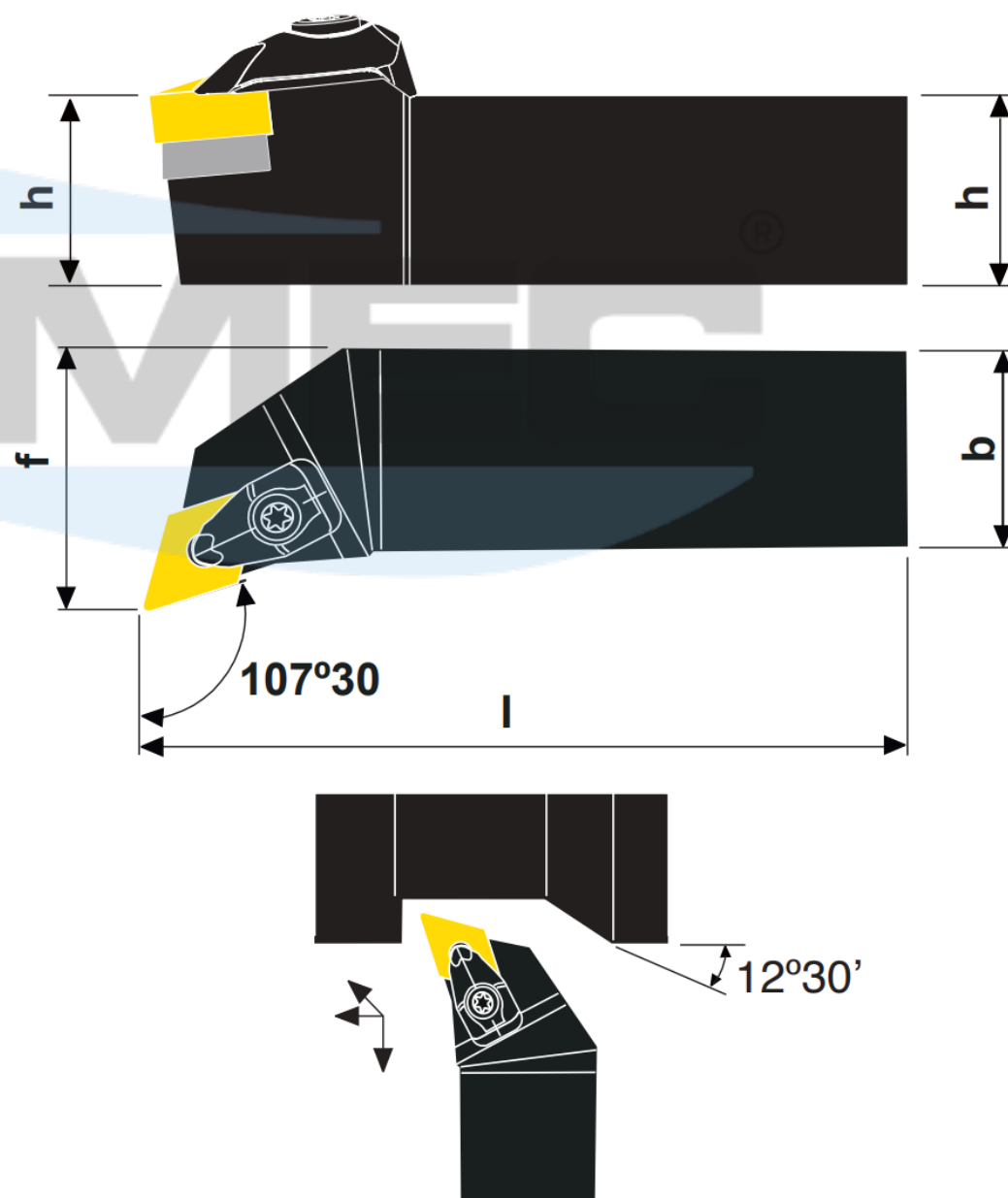
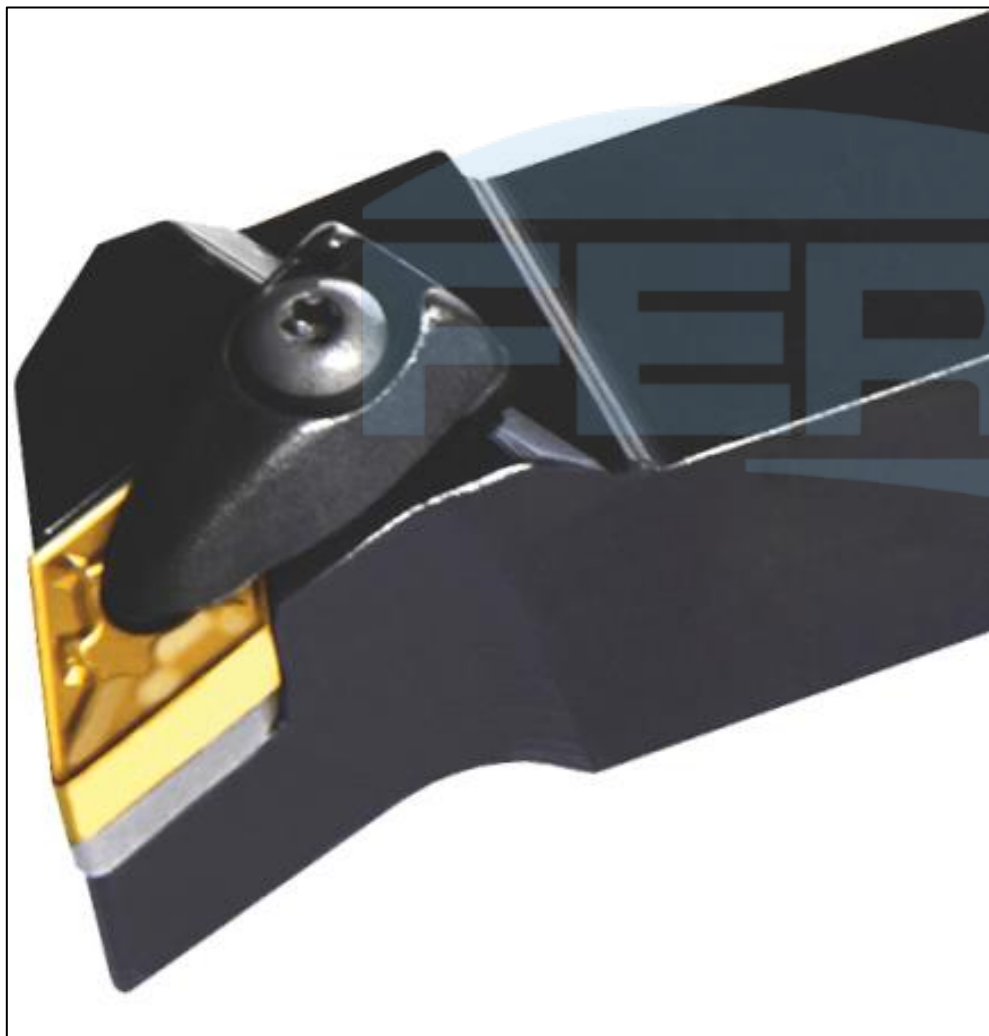

Ilustração na versão direita

Produtos	Dimensões (mm)				Pastilha 	Acessórios						
	h	b	l	f		 Grampo	 Paraf. do Grampo	 Calço	 Paraf. do Calço	 Pino	 Mola	 Chave Torx
DDHNR/L 2020 K11	20	20	125	25	DN_1104	5412 028-01	5412 086-01	5322 267-01	5513 020-04	5412 030-255	5412 001-57	T09-F
DDHNR/L 2525 M11	25	25	150	32								
DDHNR/L 3225 P15	32	25	170	32	DN_1506	5412 028-02	5412 086-02	5322 266-02	5513 020-02	5412 030-307	5412 001-58	T15-F
DDHNR/L 2020 K15	20	20	125	25								
DDHNR/L 2525 M15	25	25	150	32								
DDHNR/L 3232 P15	32	32	170	40								

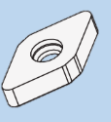
SISTEMA DE FIXAÇÃO RÍGIDA

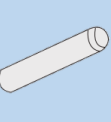
DDNNN

Suporte neutro para torneiar e facear 62°30' com pastilha 55°











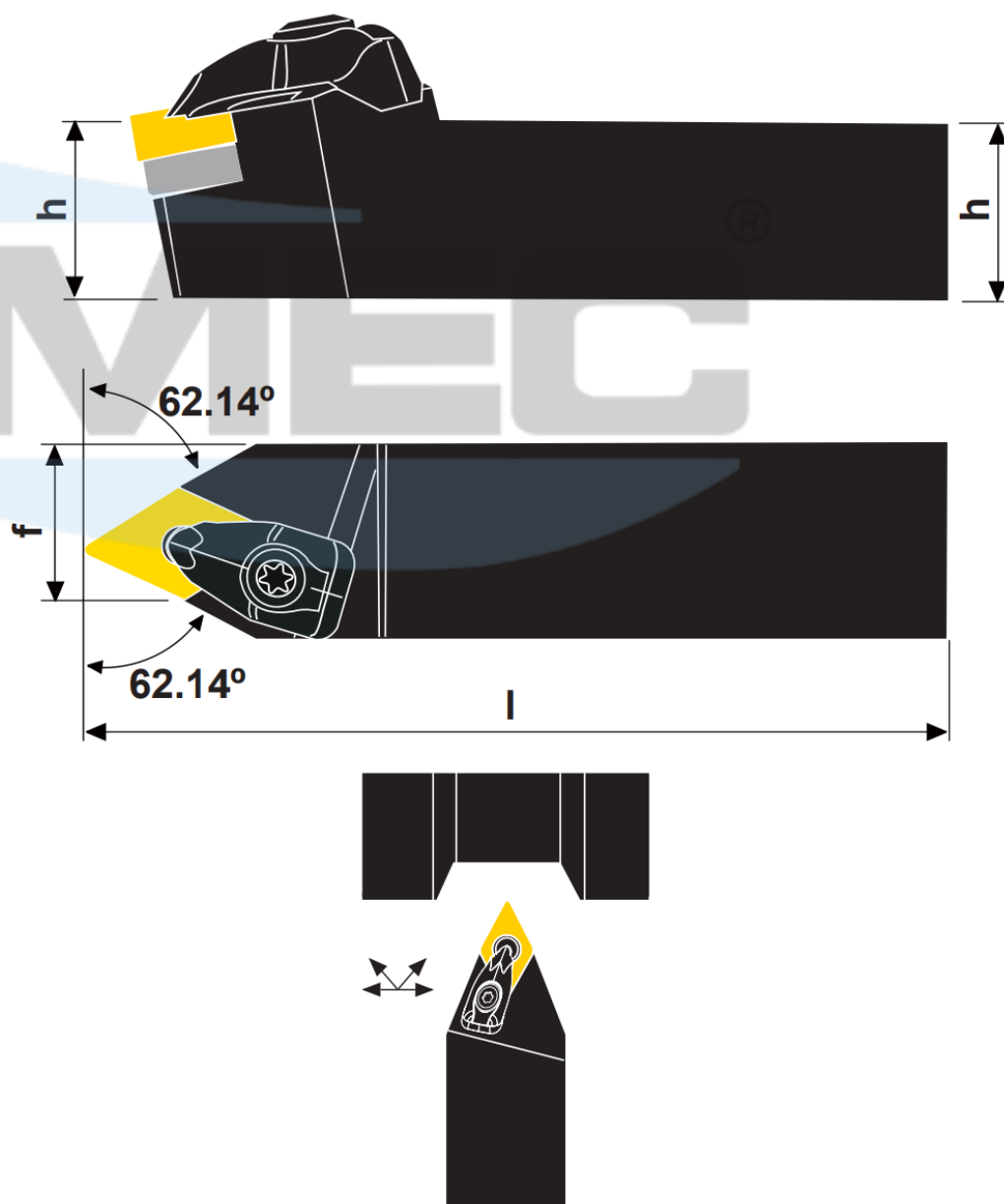
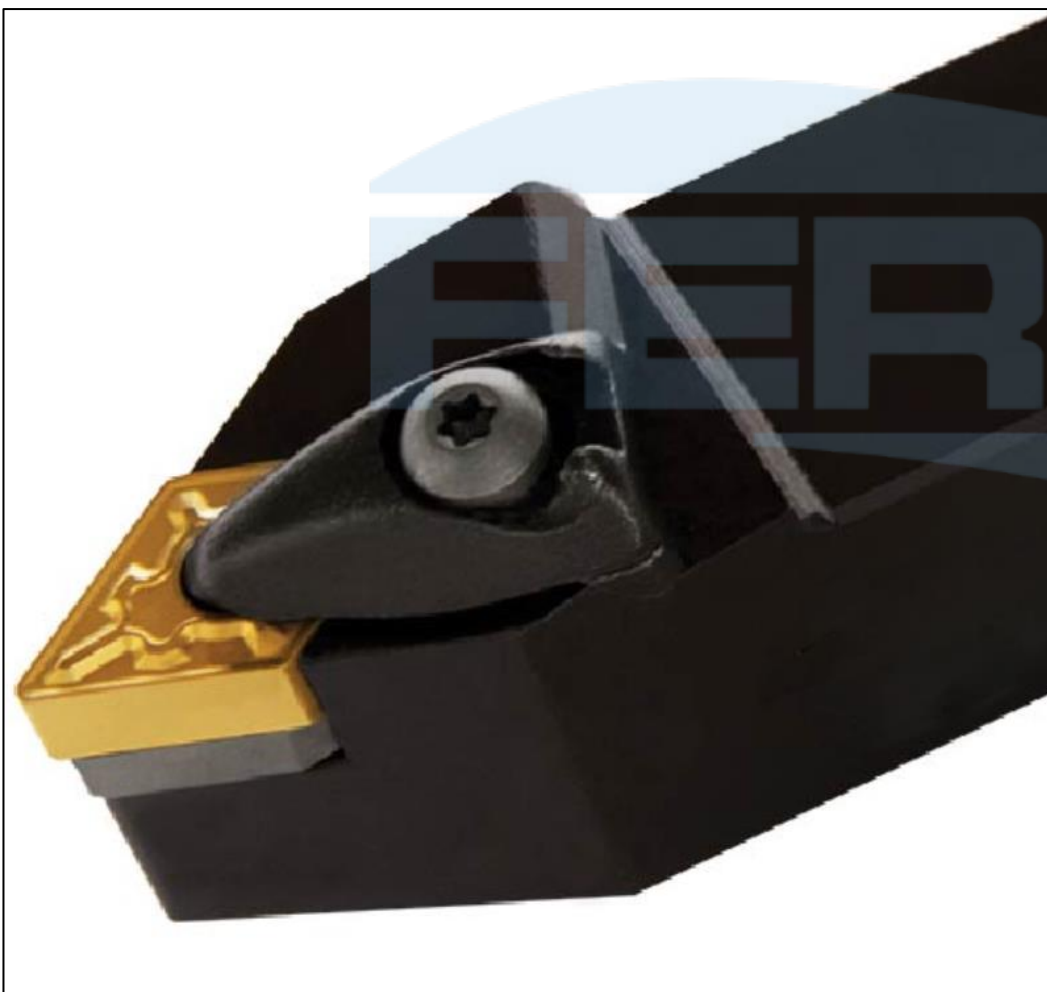













Ilustração na versão direita

Produtos	Dimensões (mm)				Pastilha	Acessórios						
	h	b	l	f			 Grampo	 Paraf. do Grampo	 Calço	 Paraf. do Calço	 Pino	 Mola
DDNNN 2020 K11	20	20	125	10,5	DN_1104							
DDNNN 2525 M11	25	25	150	13								
DDNNN 2525 M15	25	25	150	13	DN_1506							
DDNNN 3225 P15	32	25	170	13								
DDNNN 3232 P15	32	25	170	16,5								
DDNNN 4040 S15	32	32	170	40								

SISTEMA DE FIXAÇÃO RÍGIDA

DRDNN

Suporte neutro para torneiar com pastilha negativa redonda











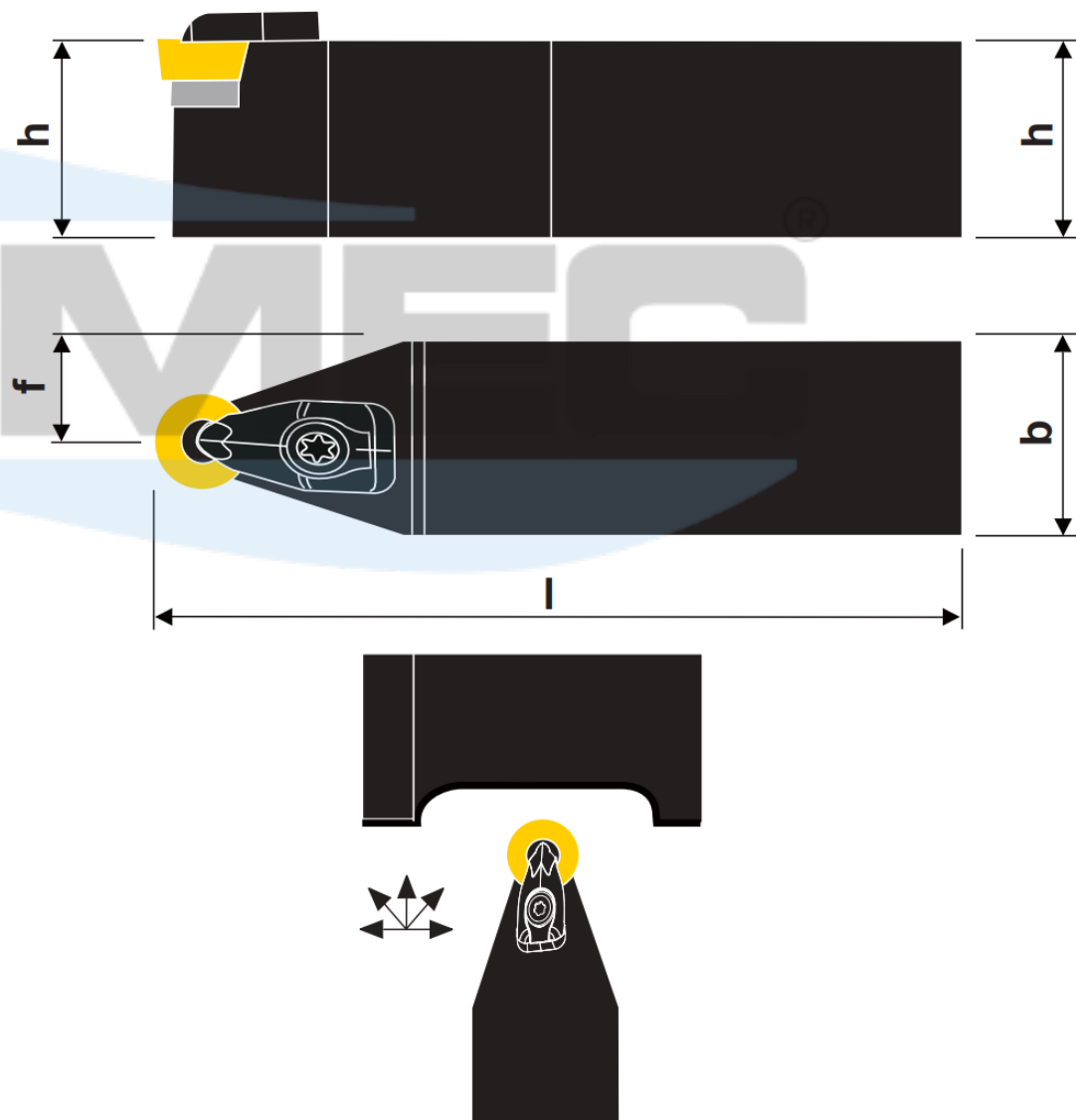

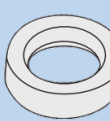

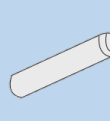



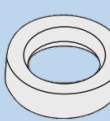

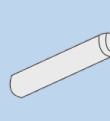



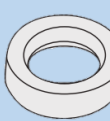

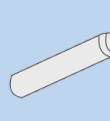



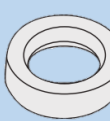

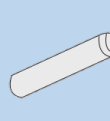



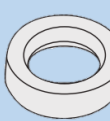

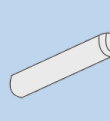



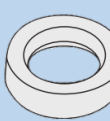

Ilustração na versão direita

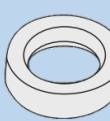

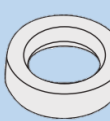

Produtos	Dimensões (mm)				Pastilha	Acessórios													
	h	b	l	f		 Grampo	 Paraf. do Grampo	 Calço	 Paraf. do Calço	 Pino	 Mola	 Chave Torx							
DRDNN 2020 K06	20	20	125	10	RN_0603														
DRDNN 2525 M06	25	25	150	12,5									5412 034-01	5412086-01	-	-	5412 030-255	5412 001-57	T7-F
DRDNN 3225 P06	32	25	170	12,5									5412 028-01	5412 086-01	5322 156-01	5513 020-04	5412 030-255	5412 001-57	T9-F
DRDNN 2020 K09	20	20	125	10	RN_0903														
DRDNN 2525 M09	25	25	150	12,5									5412 028-02	5412 086-02	5322 155-02	5513 020-02	5412 001-58	T15-F	
DRDNN 2020 K12	20	20	125	10	RN_1204														
DRDNN 2525 M12	25	25	150	12,5									5412 028-03	5412 086-03	5322 155-04	5513 020-07	5412 001-59	T20-F	
DRDNN 3225 P15	32	25	170	12,5	RN_1506														
DRDNN 3232 P19	32	32	170	16	RN_1906														
DRDNN 4040 S19	40	40	250	20	RN_2509														
DRDNN 4040 S25	40	40	250	20	RN_2509					5412 001-61	5412 001-61	T25-F							

SISTEMA DE FIXAÇÃO RÍGIDA

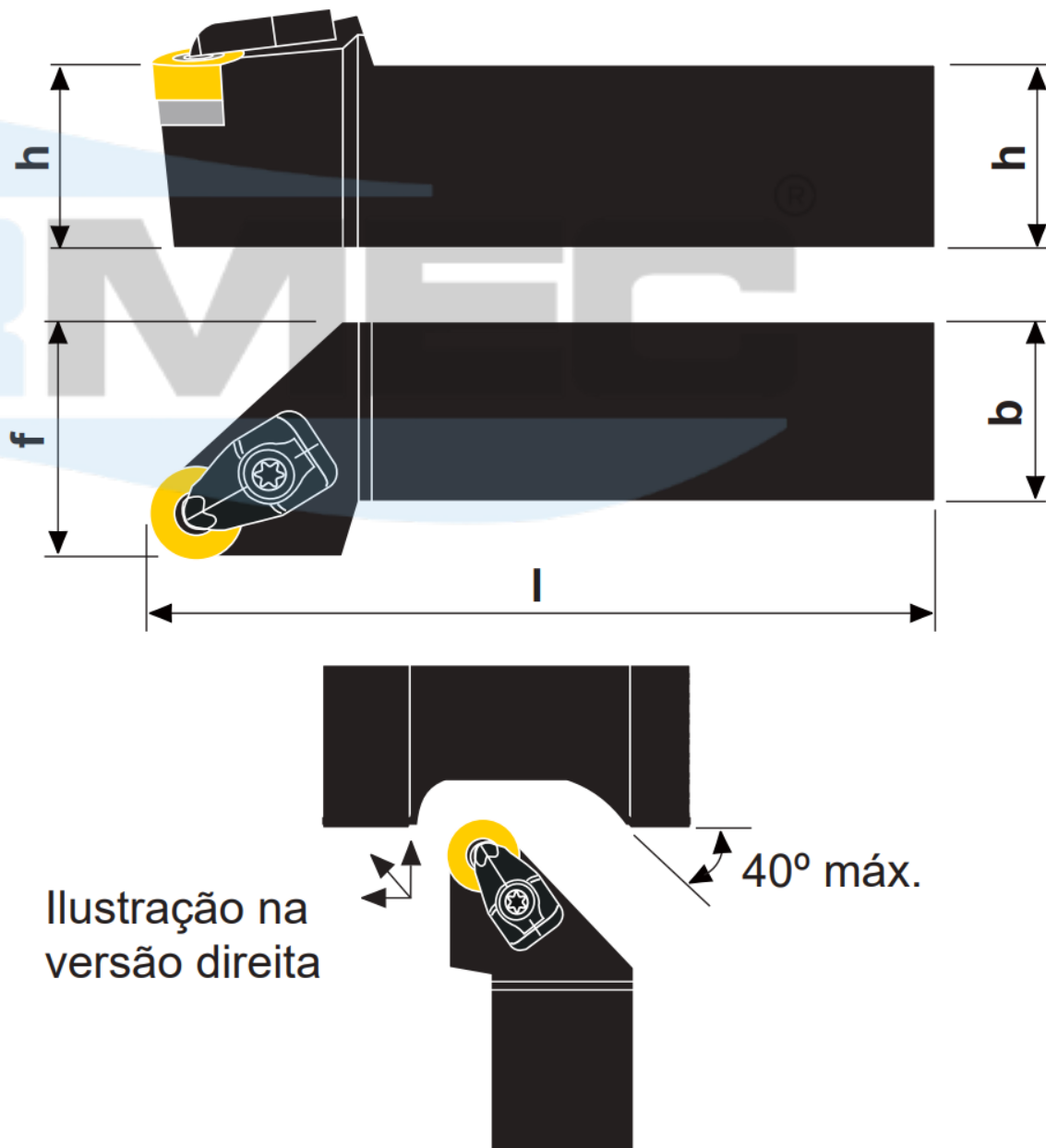
DRSNR

Suporte para tornear e facear com pastilha negativa redonda

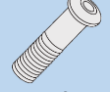
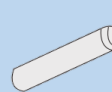

Produtos	Dimensões (mm)				Pastilha	Acessórios						
	h	b	l	f								
DRSNR/L 2020 K09	20	20	125	25	RN_0903	5412 028-01	5412 086-01	5322 156-01	5513 020-04	5412 030-255	5412 001-57	T09-F
DRSNR/L 2525 M09	25	25	150	32								
DRSNR/L 2020 K12	20	20	125	25	RN_1204	5412 028-02	5412 086-02	5322 155-02	5513 020-02	5412 030-307	5412 001-58	T15-F
DRSNR/L 2525 M12	25	25	150	32								
DRSNR/L 3225 P15	32	25	170	32	RN_1506	5412 028-03	5412 086-03	5322 155-04	5513 020-07	5412 030-307	5412 001-59	T20-F
DRSNR/L 3232 P19	32	32	170	40	RN_1906	5412 028-04						
DRSNR/L 4040 S25	40	40	250	50	RN_2509	5412 028-05	5412 086-04	5322 155-07	5513 020-08	5412 001-61	T25-F	

SISTEMA DE FIXAÇÃO RÍGIDA

DSBNR

Suporte para torneiar 75° com pastilha negativa quadrada











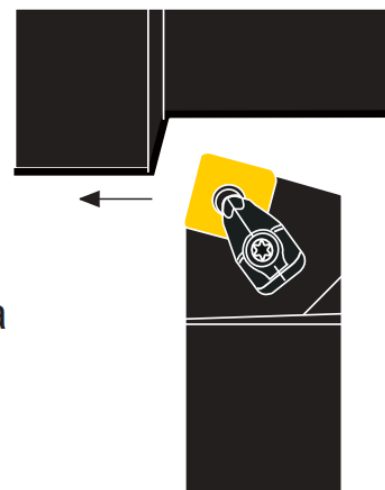
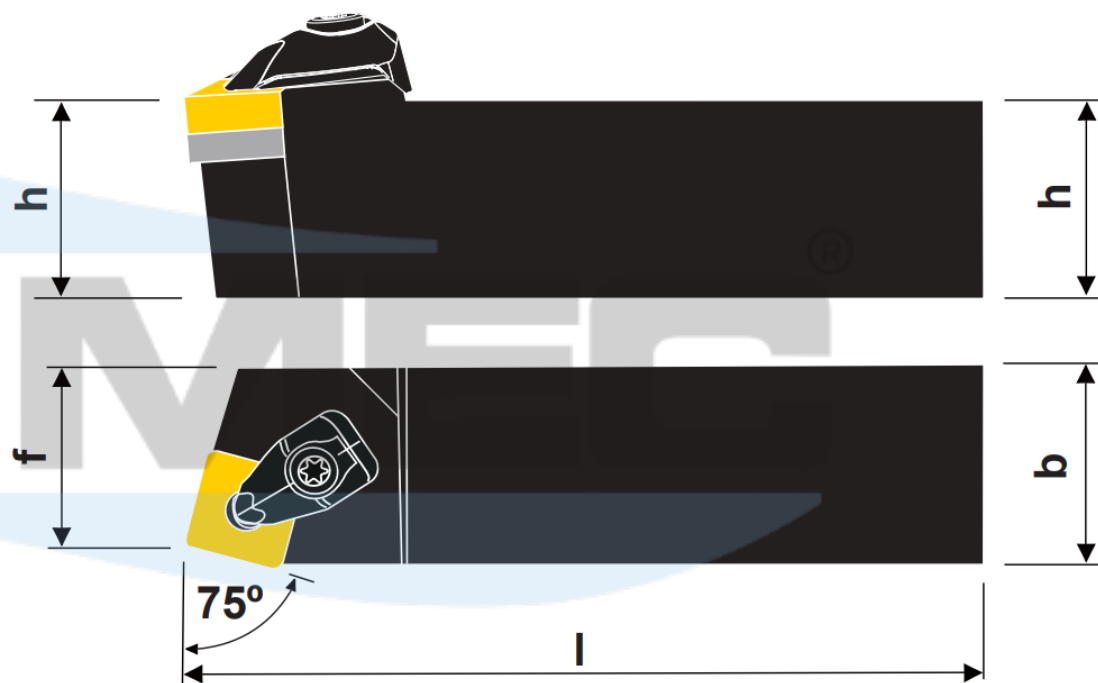



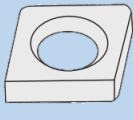
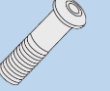



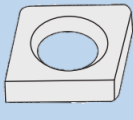
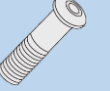





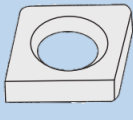
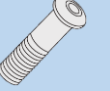





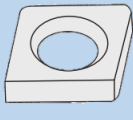
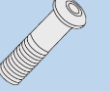





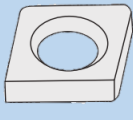
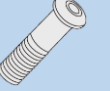

Ilustração na versão direita



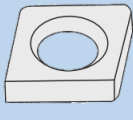
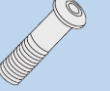





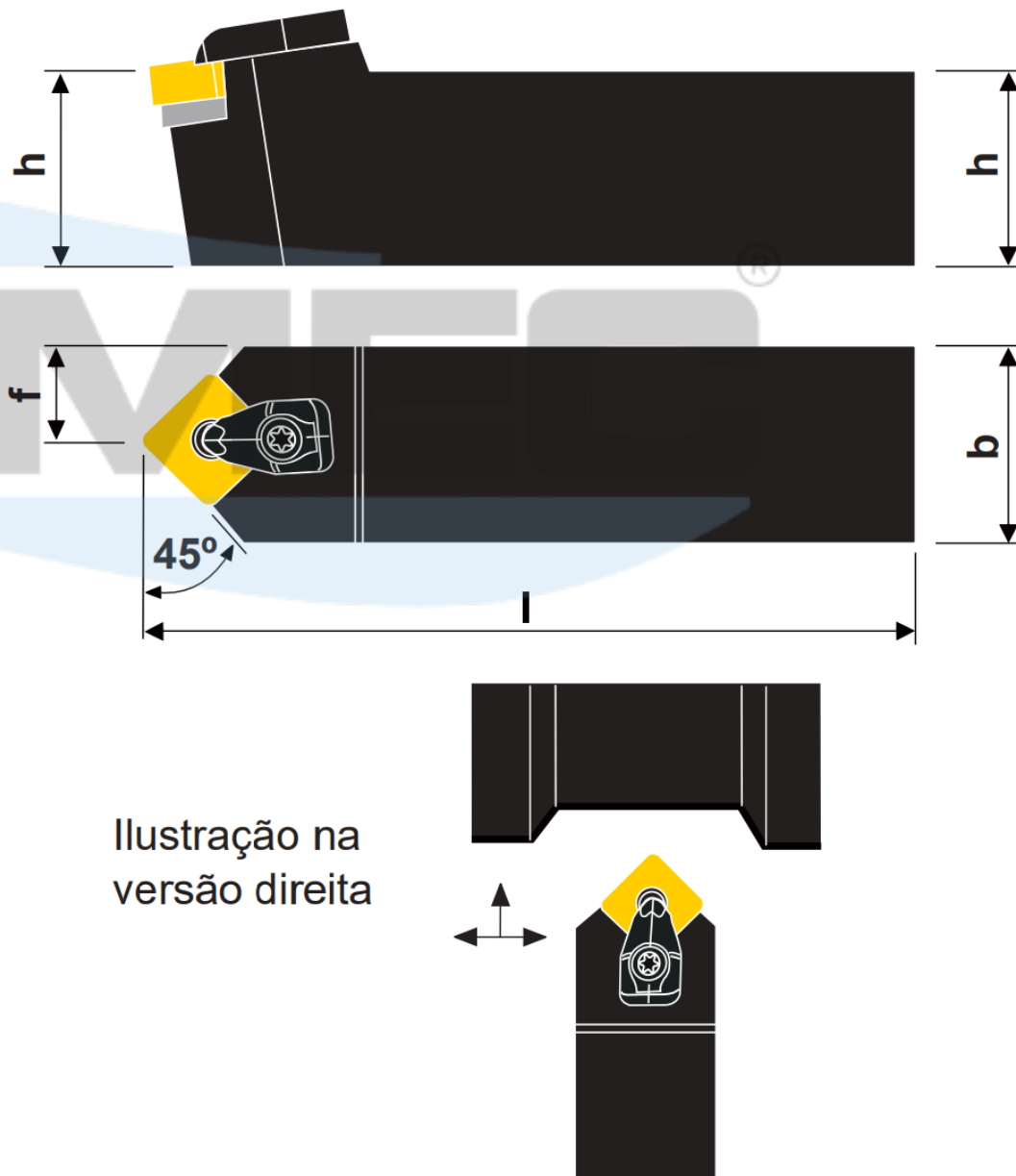



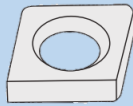
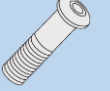





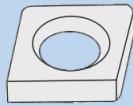
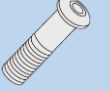





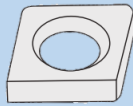
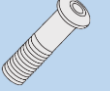





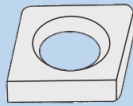
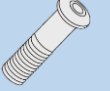



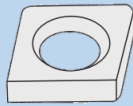
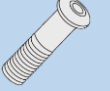

Produtos	Dimensões (mm)				Pastilha	Acessórios						
	h	b	l	f								
DSBNR/L 1616 H09	16	16	100	13	SN_0903							
DSBNR/L 2020 K09	20	20	125	17								
DSBNR/L 2525 M09	25	25	150	22								
DSBNR/L 2020 K12	20	20	125	17	SN_1204							
DSBNR/L 2525 M12	25	25	150	22								
DSBNR/L 3232 P12	32	32	170	22	SN_1506							
DSBNR/L 2525 M15	25	25	150	22								
DSBNR/L 3232 P15	32	32	170	27								
DSBNR/L 3232 P19	32	32	170	27	SN_1906							
DSBNR/L 4040 S19	40	40	250	35								
DSBNR/L 4040 S25	40	40	250	35	SN_2507							
DSBNR/L 5050 T25	50	50	300	43								

SISTEMA DE FIXAÇÃO RÍGIDA

DSDNN

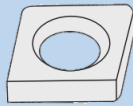
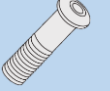
Suporte neutro para torneiar 45° com pastilha quadrada



Produtos	Dimensões (mm)				Pastilha	Acessórios							
	h	b	l	f			 Grampo	 Paraf. do Grampo	 Calço	 Paraf. do Calço	 Pino	 Mola	 Chave Torx
DSDNN 1616 H09	16	16	100	8,3	SN_0903								
DSDNN 2020 K09	20	20	125	10,3									
DSDNN 2525 M09	25	25	150	12,8									
DSDNN 2020 K12	20	20	125	10,3	SN_1204								
DSDNN 2525 M12	25	25	150	12,8									
DSDNN 3232 P12	32	25	170	12,8									
DSDNN 2525 M15	25	25	150	12,8	SN_1506								
DSDNN 3232 P15	32	25	170	13									
DSDNN 3232 P19	32	32	170	16,5	SN_1906								
DSDNN 4040 S19	40	40	250	21									
DSDNN 4040 S25	40	40	250	21	SN_2507								
DSDNN 5050 T25	50	50	300	26									

SISTEMA DE FIXAÇÃO RÍGIDA

DSKNR

Suporte para facear 75° com pastilha negativa quadrada











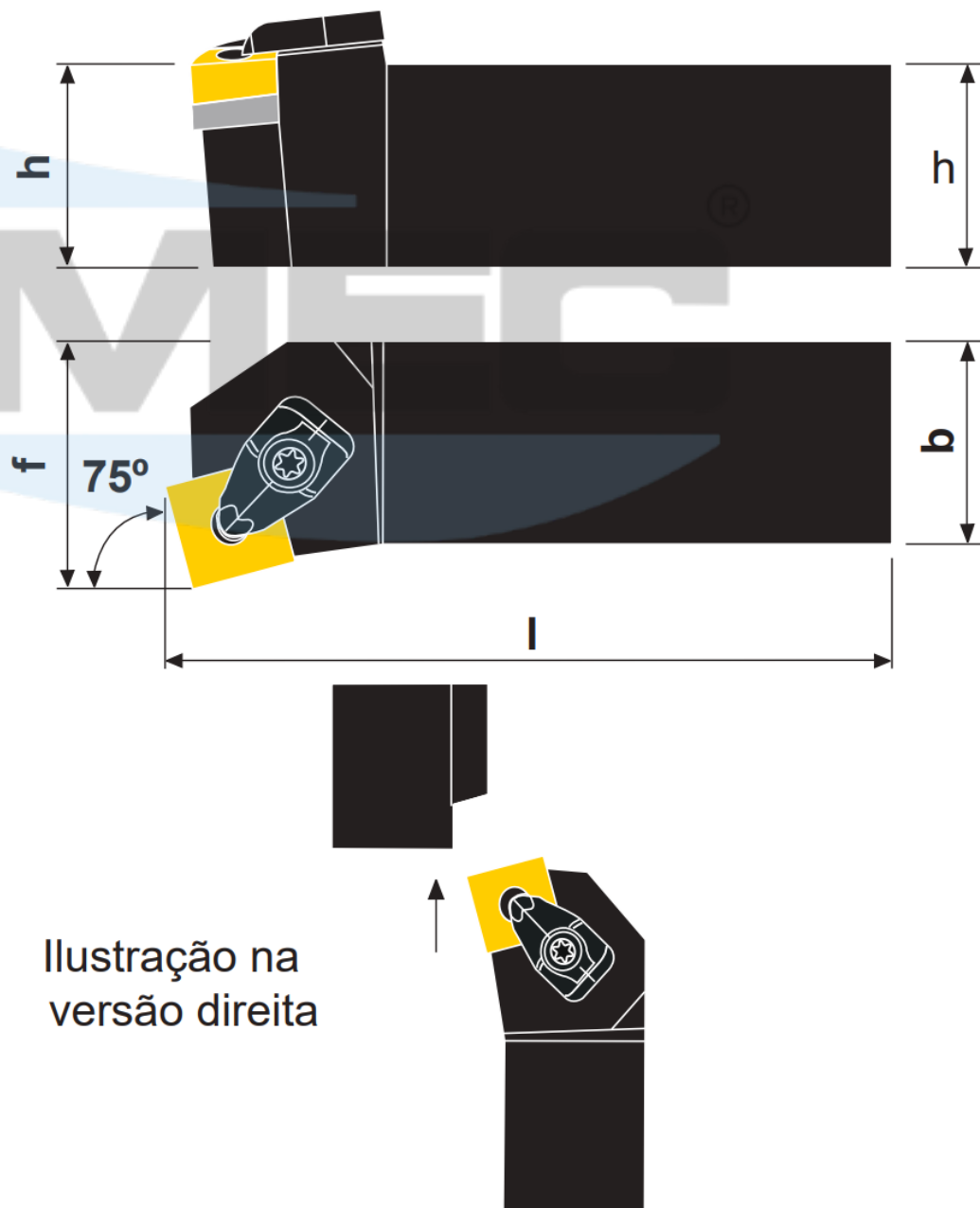
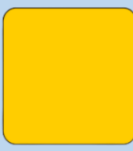

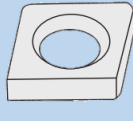
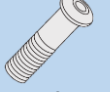
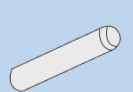

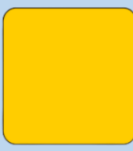

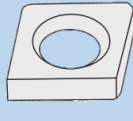
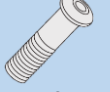
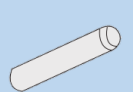

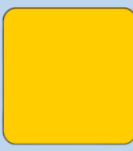
Ilustração na versão direita

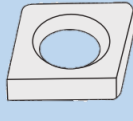
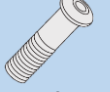
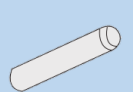
Produtos	Dimensões (mm)				Pastilha	Acessórios							
	h	b	l	f			 Grampo	 Paraf. do Grampo	 Calço	 Paraf. do Calço	 Pino	 Mola	 Chave Torx
DSKNR/L 1616 H09	16	16	100	20	SN_0903								
DSKNR/L 2020 K09	20	20	125	25									
DSKNR/L 2525 M09	25	25	150	32									
DSKNR/L 2020 K12	20	20	125	25	SN_1204								
DSKNR/L 2525 M12	25	25	150	32									
DSKNR/L 3225 P12	32	25	170	32									
DSKNR/L 3232 P19	32	32	170	40	SN_1906								
DSKNR/L 4040 P19	40	40	170	50									

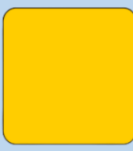
SISTEMA DE FIXAÇÃO RÍGIDA

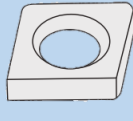
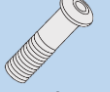
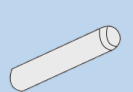
DSSNR

Suporte para torneiar e facear 45° com pastilha negativa quadrada











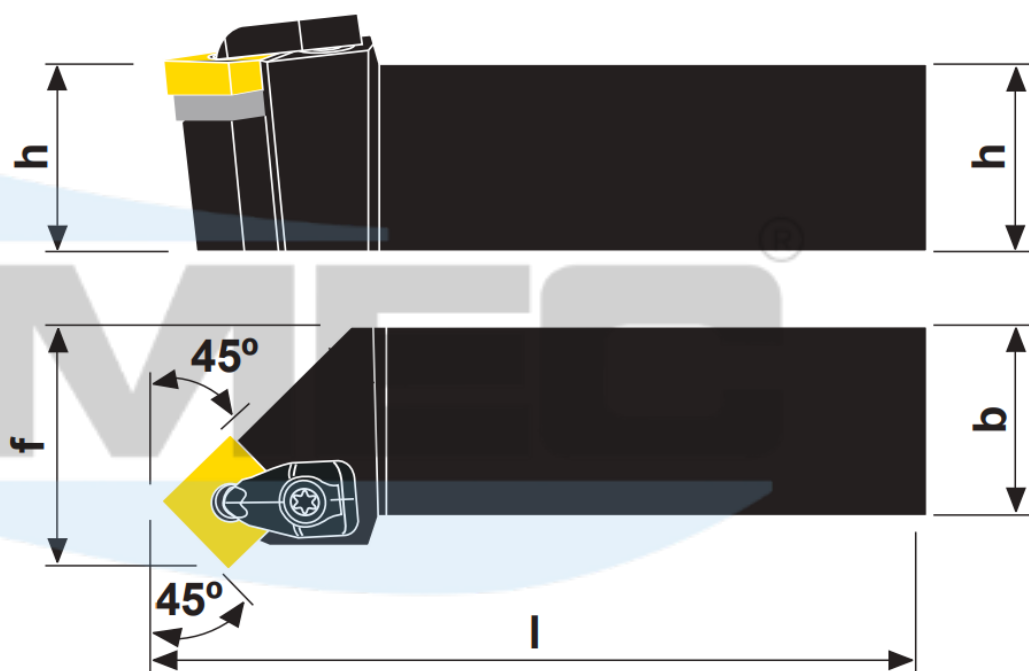
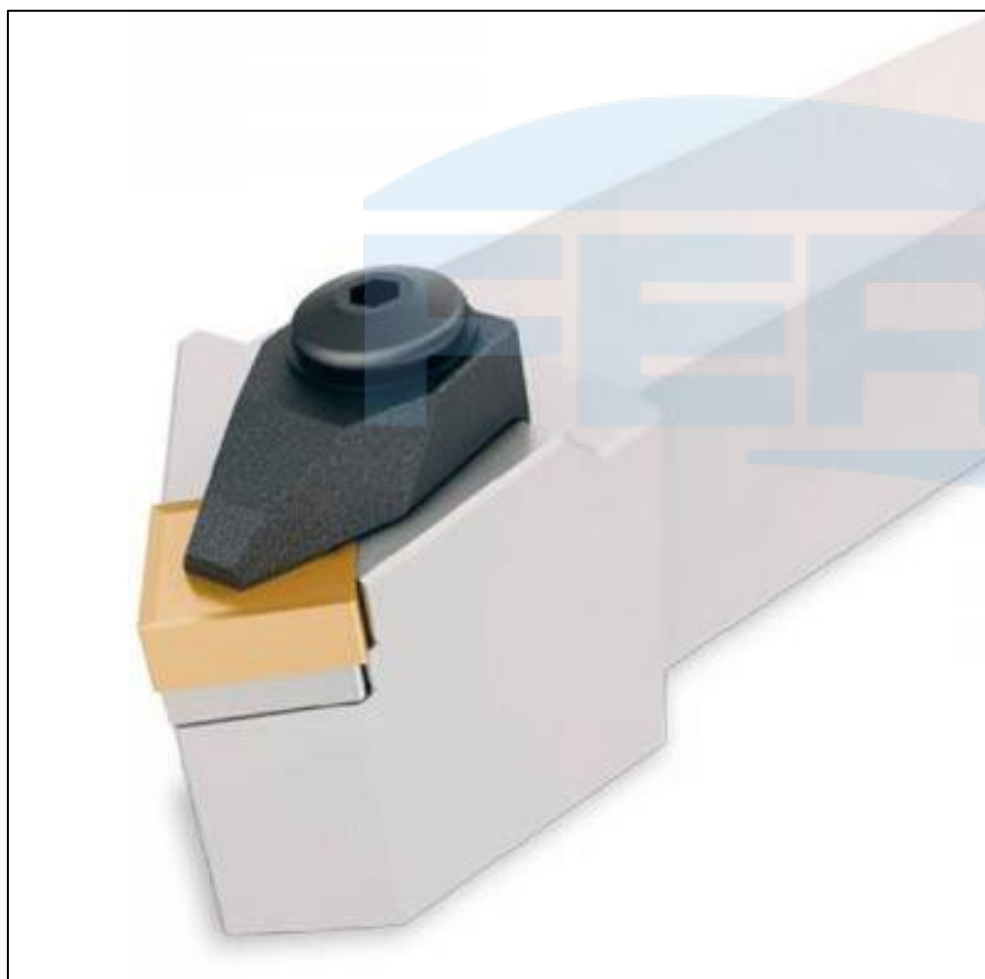
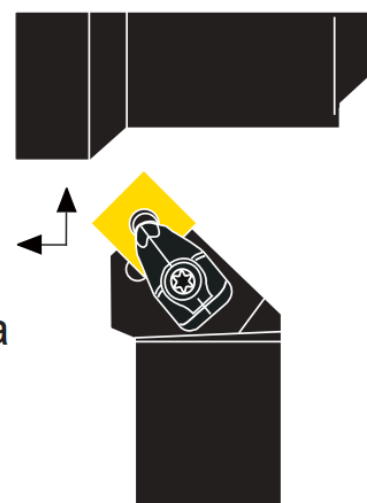



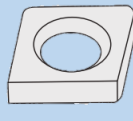
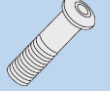



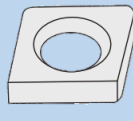
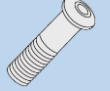





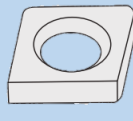
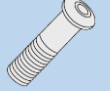





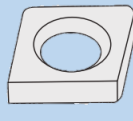
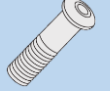





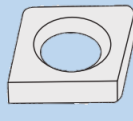
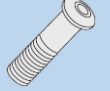

Ilustração na versão direita

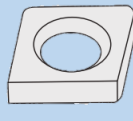
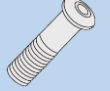

Produtos	Dimensões (mm)				Pastilha	Acessórios						
	h	b	l	f			 Grampo	 Paraf. do Grampo	 Calço	 Paraf. do Calço	 Pino	 Mola
DSSNR/L 1616 H09	16	16	100	20	SN_0903							
DSSNR/L 2020 K09	20	20	125	25								
DSSNR/L 2525 M09	25	25	150	32								
DSSNR/L 2020 K12	20	20	125	25	SN_1204							
DSSNR/L 2525 M12	25	25	150	32								
DSSNR/L 3225 P12	32	25	170	32								
DSSNR/L 2525 M15	25	25	150	32	SN_1506							
DSSNR/L 3232 P15	32	32	170	40								
DSSNR/L 3232 P19	32	32	170	40	SN_1906							
DSSNR/L 4040 S19	40	40	250	50								
DSSNR/L 4040 S25	40	40	250	50	SN_2507							
DSSNR/L 5050 T25	50	50	300	60								

SISTEMA DE FIXAÇÃO RÍGIDA

DTFNR

Suporte para facear 91° com pastilha negativa triangular











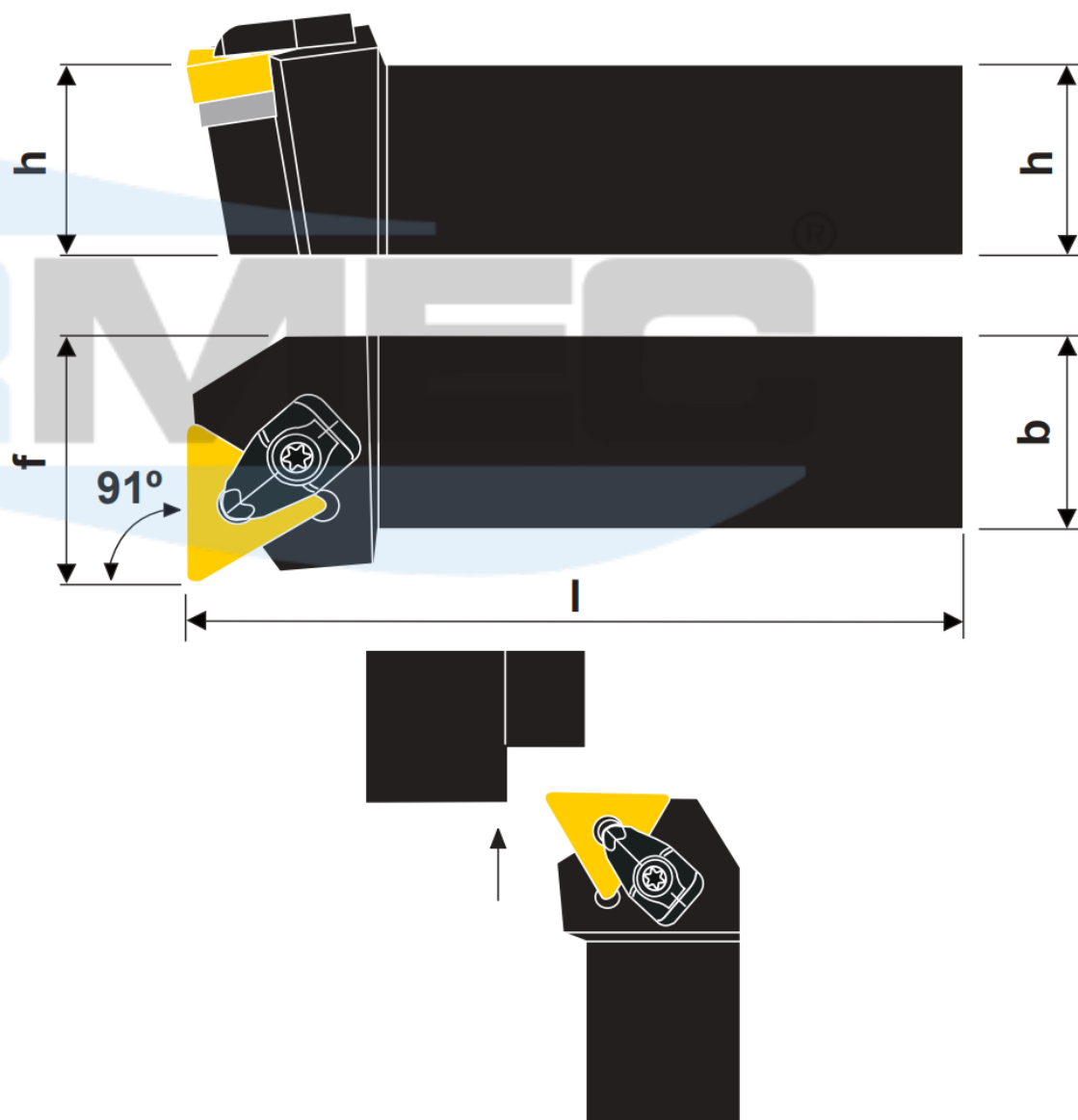
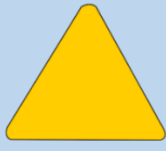











Ilustração na versão direita

Produtos	Dimensões (mm)				Pastilha	Acessórios						
	h	b	l	f			 Grampo	 Paraf. do Grampo	 Calço	 Paraf. do Calço	 Pino	 Mola
DTFNR/L 2020 K16	20	20	125	25	TN_1604							
DTFNR/L 2525 M16	25	25	150	32								
DTFNR/L 3225 P16	32	25	170	32								
DTFNR/L 2525 M22	25	25	150	32	TN_2204							
DTFNR/L 3232 P22	32	32	170	40								

SISTEMA DE FIXAÇÃO RÍGIDA

DTGNR

Suporte para torneiar 91° com pastilha negativa triangular











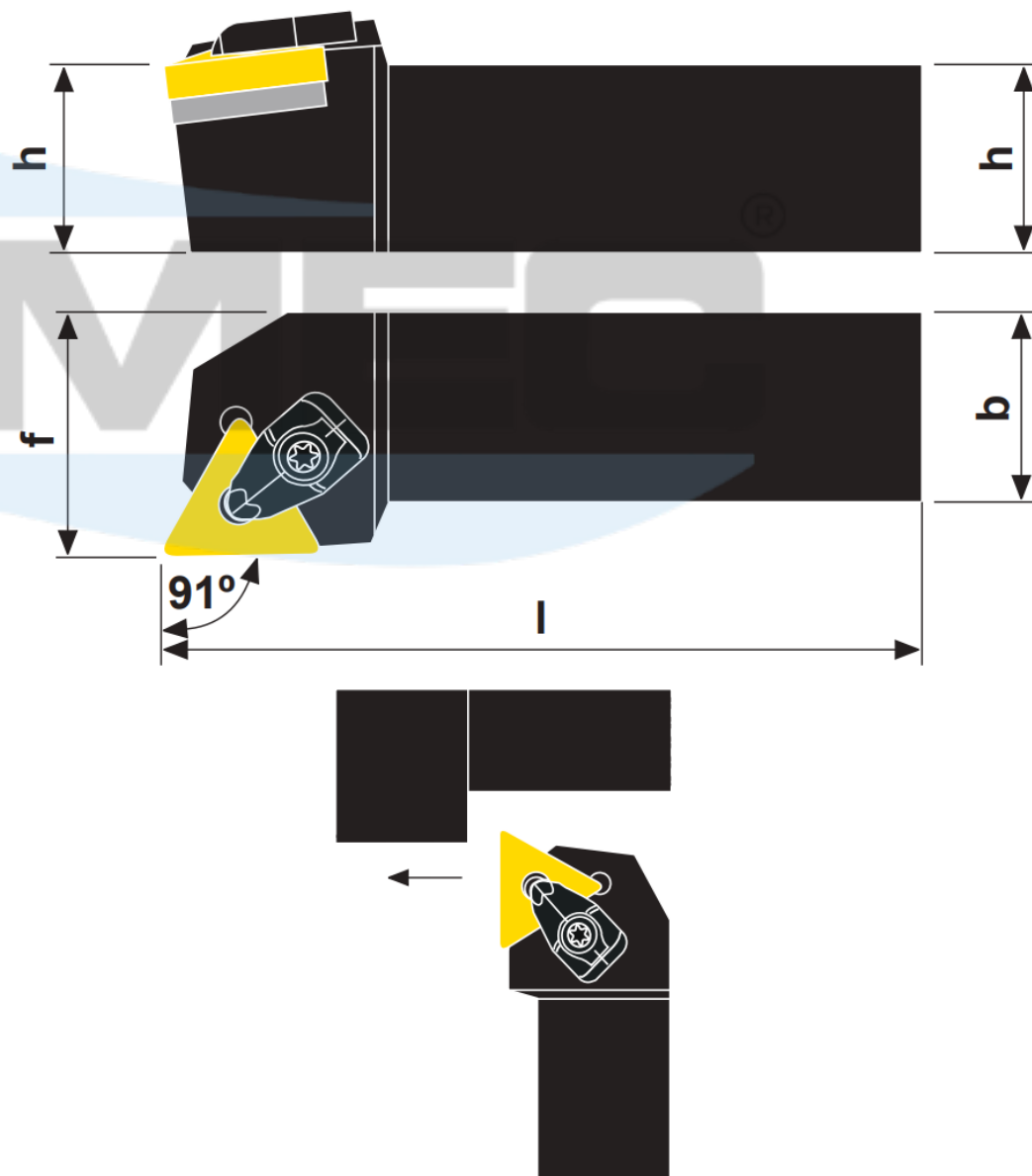
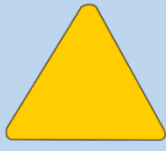







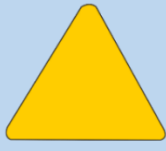





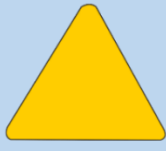

Ilustração na versão direita

Produtos	Dimensões (mm)				Pastilha	Acessórios							
	h	b	l	f			 Grampo	 Paraf. do Grampo	 Calço	 Paraf. do Calço	 Pino	 Mola	 Chave Torx
DTGNR/L 2020 K16	20	20	125	25	TN_1604								
DTGNR/L 2525 M16	25	25	150	32									
DTGNR/L 3225 P16	32	25	170	32									
DTGNR/L 2525 M22	25	25	150	32	TN_2204								
DTGNR/L 3232 P22	32	32	170	40									

SISTEMA DE FIXAÇÃO RÍGIDA

DTJNR

Suporte para torneiar 93° com pastilha negativa triangular











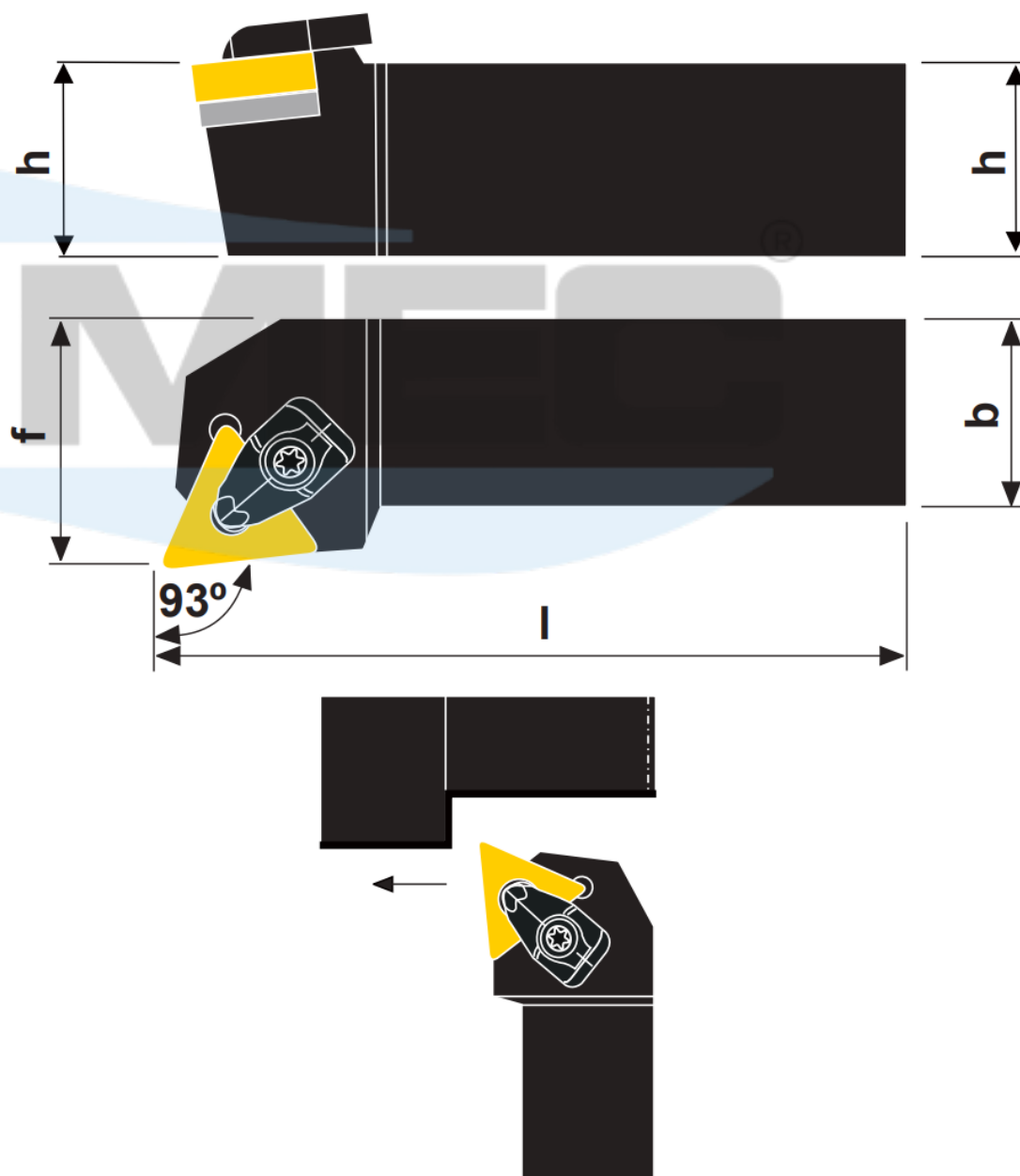
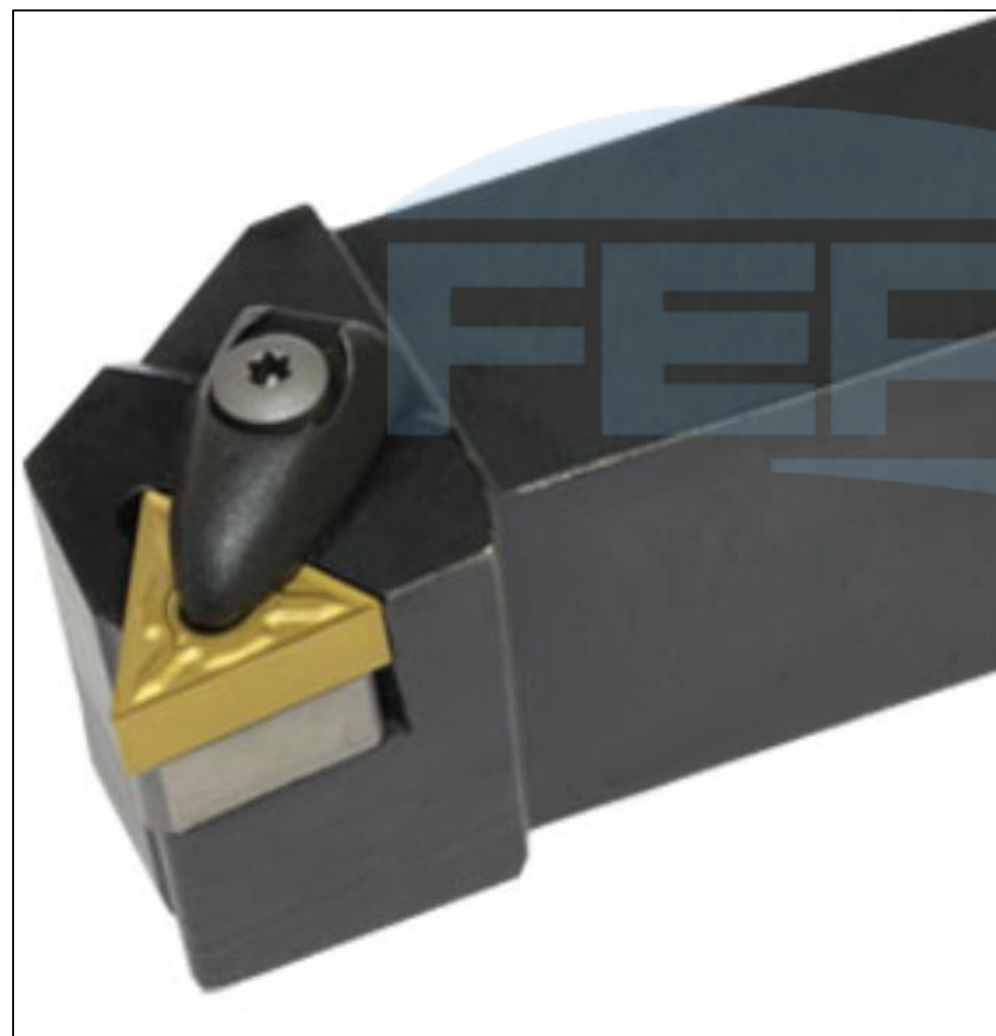
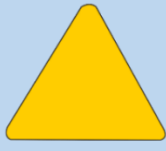











Ilustração na versão direita

Produtos	Dimensões (mm)				Pastilha	Acessórios						
	h	b	l	f			 Grampo	 Paraf. do Grampo	 Calço	 Paraf. do Calço	 Pino	 Mola
DTJNR/L 2020 K16	20	20	125	25	TN_1604							
DTJNR/L 2525 M16	25	25	150	32								
DTJNR/L 3225 P16	32	25	170	32								
DTJNR/L 2525 M22	25	25	150	32	TN_2204							
DTNR/L 3232 P22	32	32	170	40								

SISTEMA DE FIXAÇÃO RÍGIDA

DTTNR

Suporte para torneiar 60° com pastilha negativa triangular











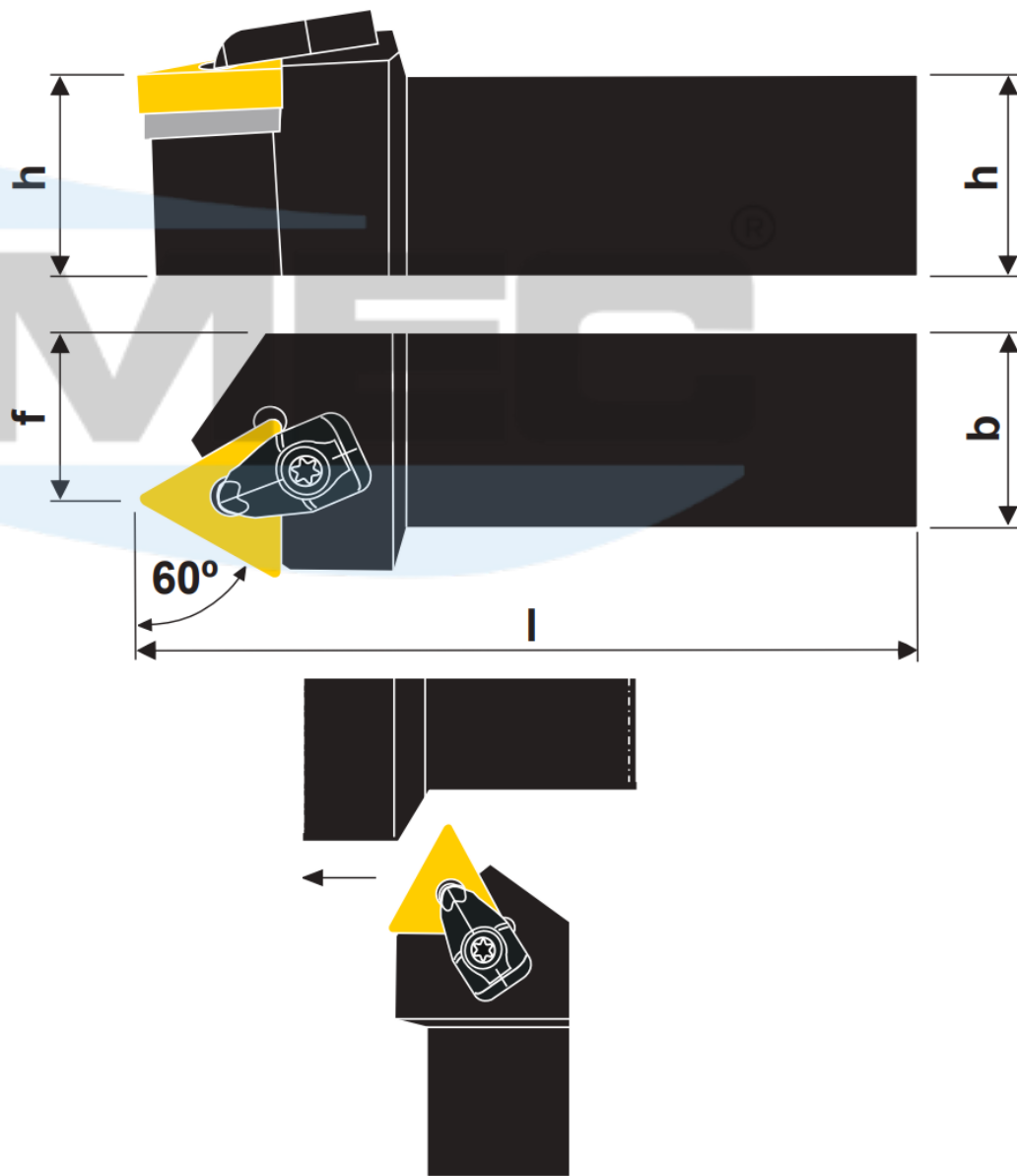
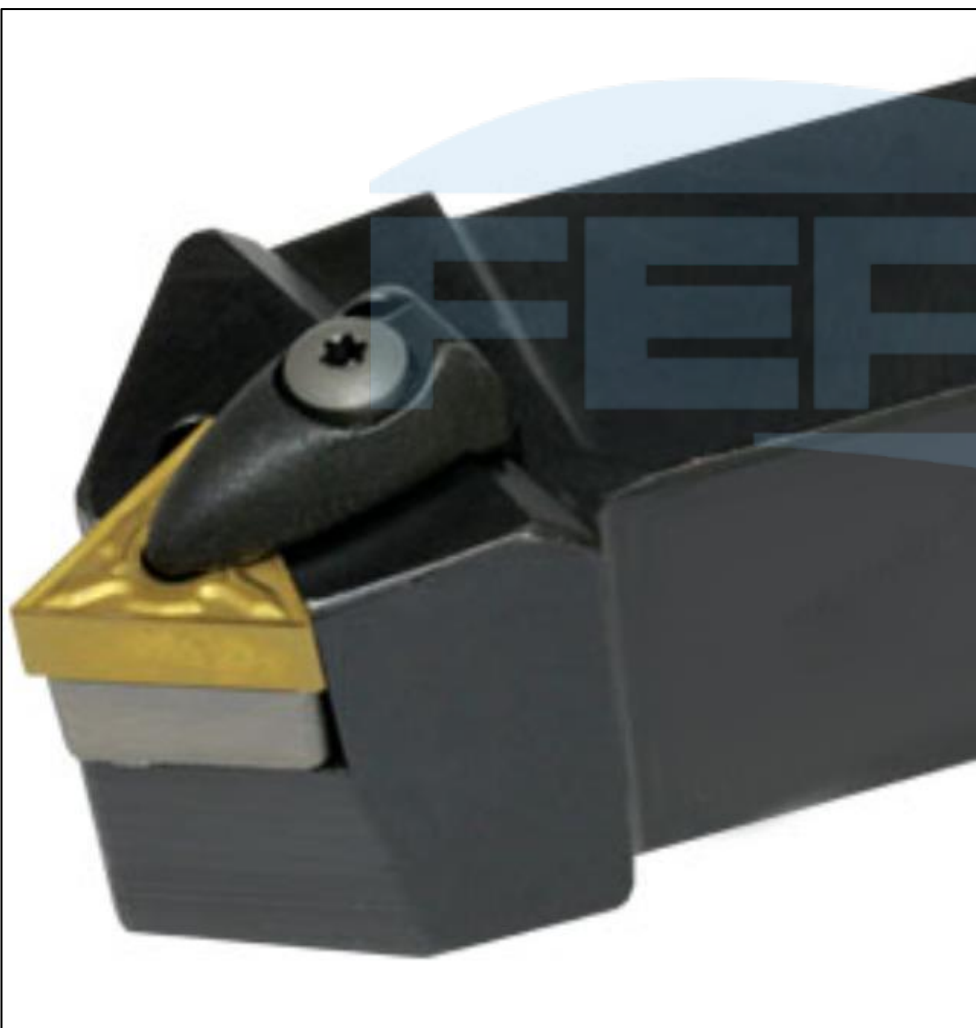
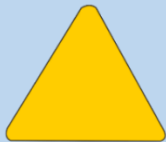

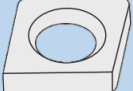





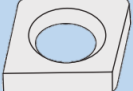

Ilustração na versão direita



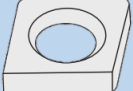





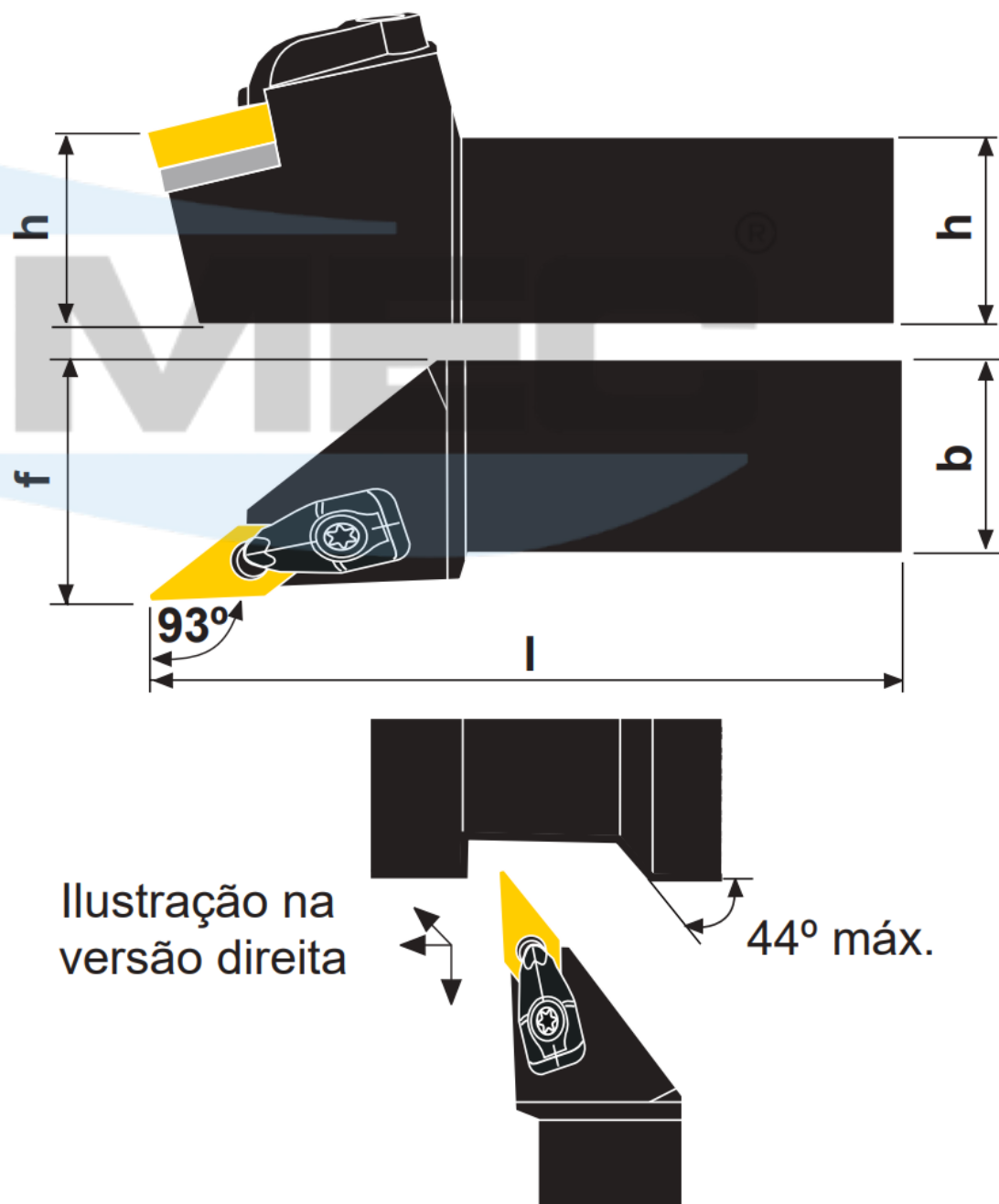





Produtos	Dimensões (mm)				Pastilha	Acessórios						
	h	b	l	f			 Grampo	 Paraf. do Grampo	 Calço	 Paraf. do Calço	 Pino	 Mola
DTTNR/L 2020 K16	20	20	125	17	TN_1604							
DTTNR/L 2525 M16	25	25	150	22								
DTTNR/L 2525 M22	25	25	150	22	TN_2204							
						5412 028-02	5412 086-02	5322 315-04	5513 020-02	5412 030-307	5412 001-58	T15-F

SISTEMA DE FIXAÇÃO RÍGIDA

DVJNR

Suporte para torneiar 93° com pastilha negativa 35°









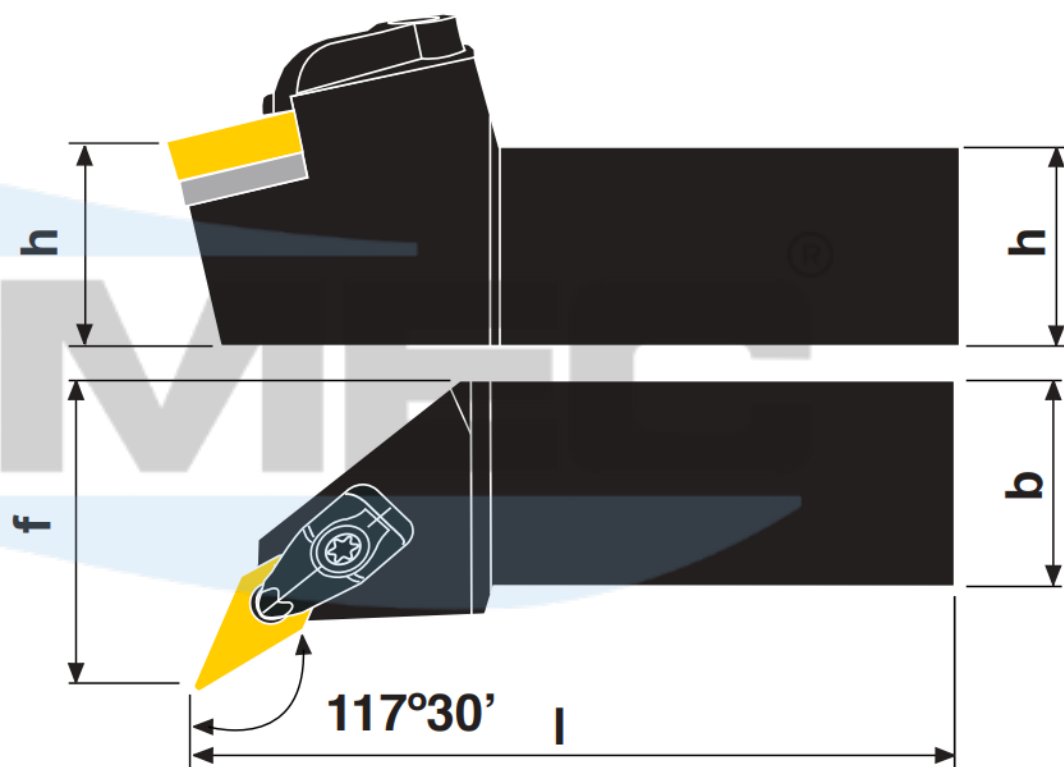

Produtos	Dimensões (mm)				Pastilha 	Acessórios						
	h	b	l	f								
DVJNR/L 2020 K16	20	20	125	25	CN_1604							
DVJNR/L 2525 M16	25	25	150	32								
DVJNR/L 3225 P16	32	25	170	32								
DVJNR/L 4040 S16	40	40	150	32								

SISTEMA DE FIXAÇÃO RÍGIDA

DVPCR

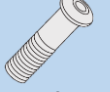
Suporte para tornear 117°30' com pastilha negativa 35°



Produtos	Dimensões (mm)				Pastilha	Acessórios						
	h	b	l	f		Grampo	Paraf. do Grampo	Calço	Paraf. do Calço	Pino	Mola	Chave Torx
DVPCR/L 2020 K16	20	20	125	25	 VN_1604	 5412 028-06	 5412 086-02	 5322 269-01	 5513 020-09	 5412 030-307	 5412 001-58	 T15-F
DVPCR/L 2525 M16	25	25	150	32								
DVPCR/L 3232 P16	32	32	170	40								
DVPCR/L 4040 S16	40	40	250	50								

SISTEMA DE FIXAÇÃO RÍGIDA

DVVNN

Suporte para tornear 72°30' com pastilha negativa 35°

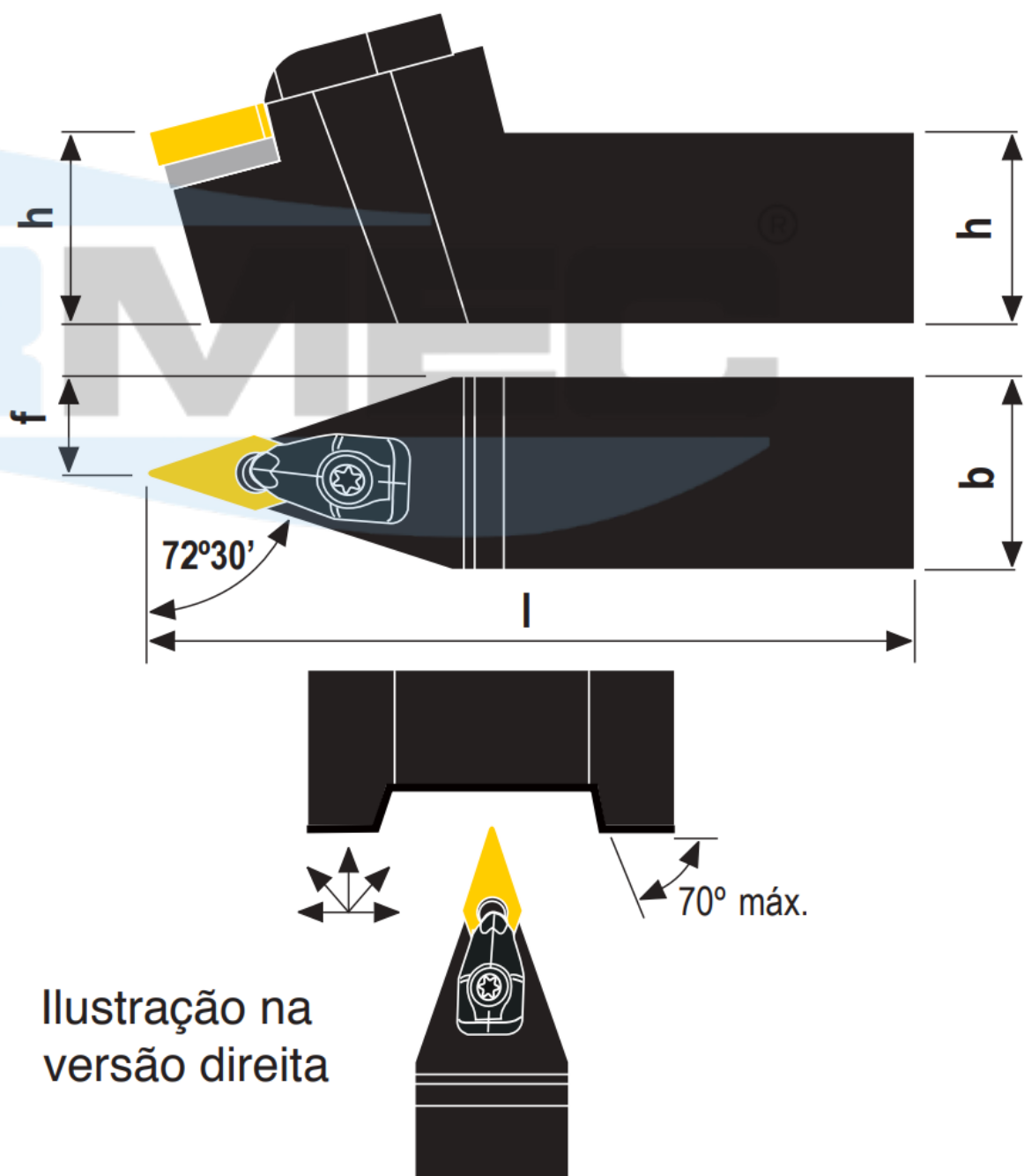

Produtos	Dimensões (mm)				Pastilha	Acessórios						
	h	b	l	f		Grampo	Paraf. do Grampo	Calço	Paraf. do Calço	Pino	Mola	Chave Torx
DVVNN 2020 K16	20	20	125	10,6	 VN_1604	 5412 028-06	 5412 086-02	 5322 269-01	 5513 020-09	 5412 030-307	 5412 001-58	 T15-F
DVVNN 2525 M16	25	25	150	13,1								
DVVNN 3232 P16	32	32	170	16,6								
DVVNN 4040 S16	40	40	250	20,6								

SISTEMA DE FIXAÇÃO RÍGIDA

DWLNR

Suporte para tornear 95° com pastilha triangular negativa 80°











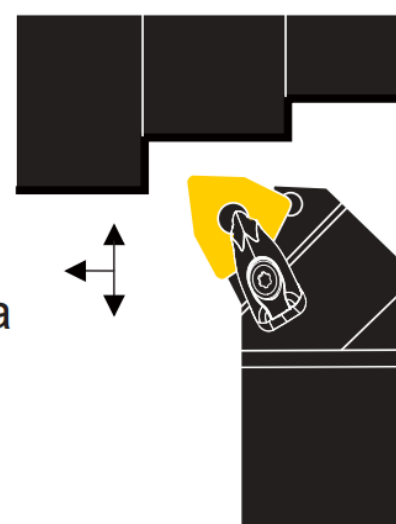
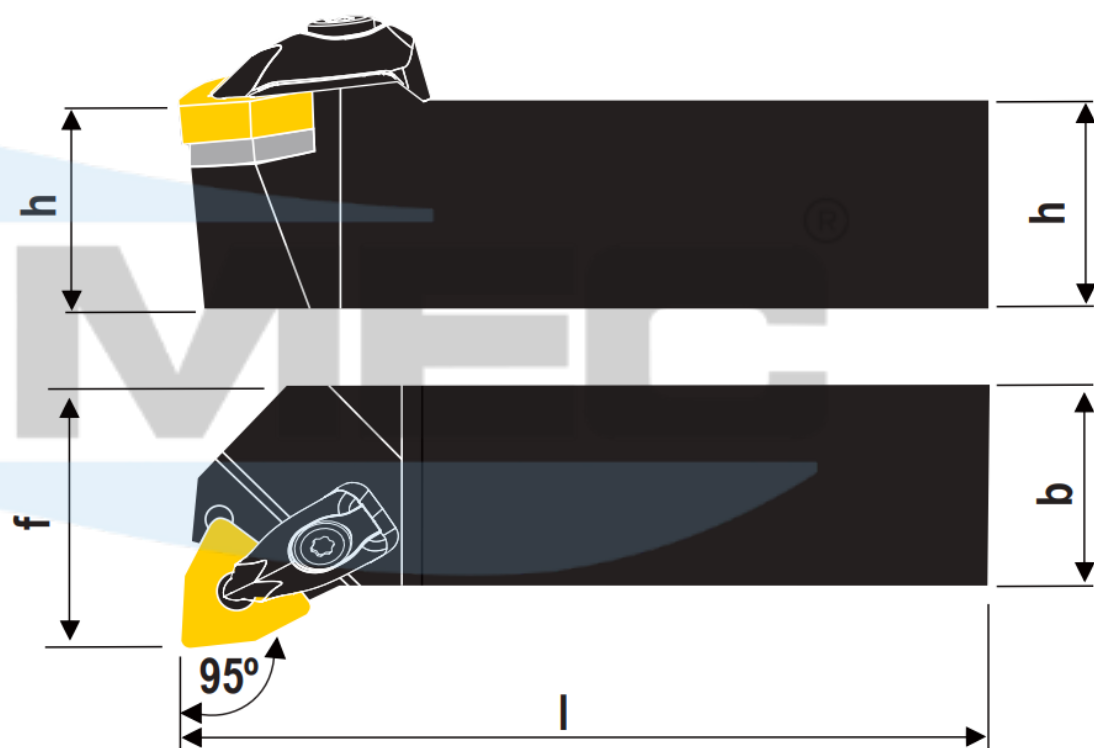
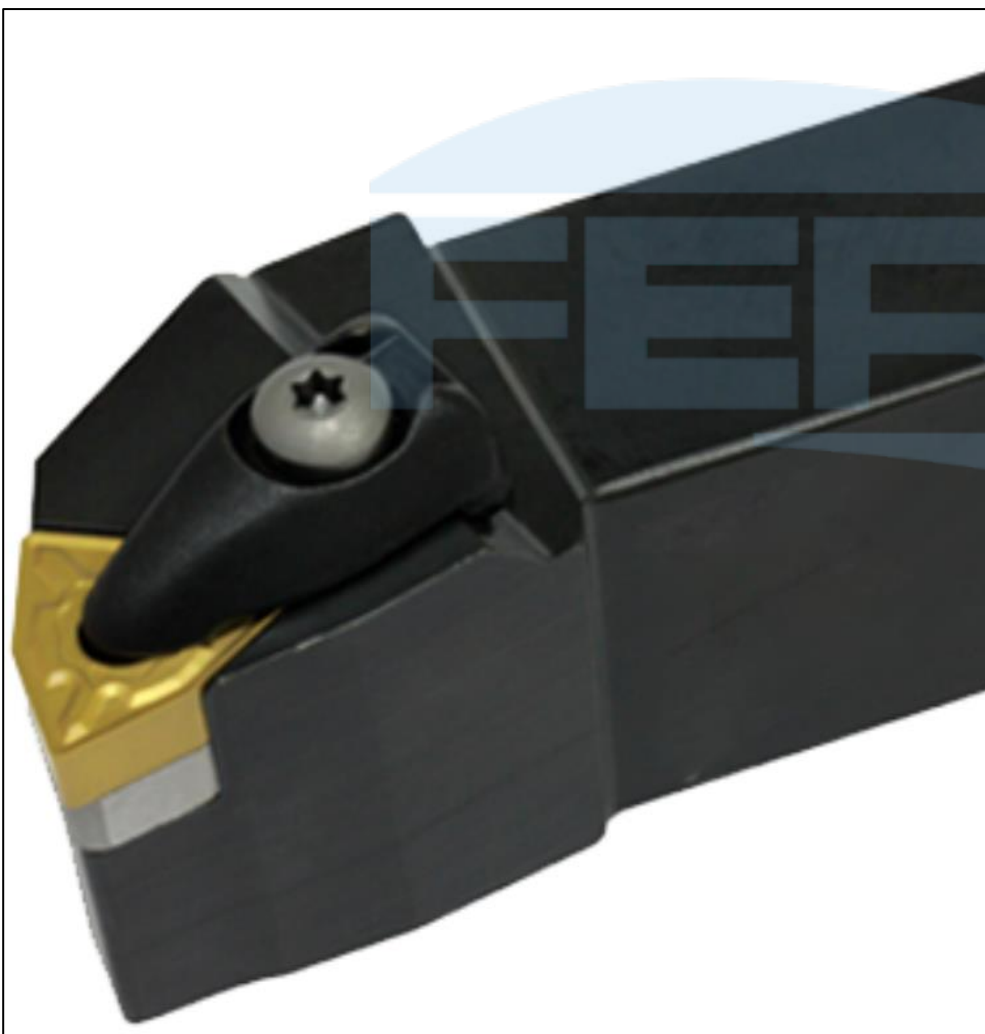



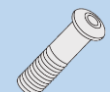





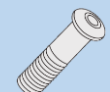

Ilustração na versão direita

Produtos	Dimensões (mm)				Pastilha	Acessórios						
	h	b	l	f								
DWLNR/L 2020 K06	20	20	125	25	WN_0604							
DWLNR/L 2525 M06	25	25	150	32								
DWLNR/L 3225 P06	32	25	170	32								
DWLNR/L 2020 K08	20	20	125	25	WN_0804							
DWLNR/L 2525 M08	25	25	150	32								
DWLNR/L 3232 P08	32	32	170	40								
DWLNR/L 4040 S08	40	40	250	50								

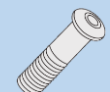

FERMEC[®]

SHARPCUT[®]
TECHNOLOGIES

ENDEREÇO: Rua Rio Verde, 1829 - Vila Palmeiras - São Paulo/SP

CEP:02934-401

TELEFONE:+55 (11) 3978-5515

E-MAIL:fermec@fermec.com.br

SITE: WWW.FERMEC.COM.BR